



MANIFEST YOUR OUTER HOME



## Therma-Tru. Manifest your outer home.

We reinvented the door, so you can reinvent your first impression.

Thanks to decades of material science expertise, Therma-Tru® doors are made from super-natural, better-than-nature materials proven to outlast and outperform wood and steel.

Therma-Tru doors seamlessly blend beauty and durability to add incredible value and stunning curb appeal. They're designed to enhance your home's aesthetic and character, and keep their allure season after season. Choosing a Therma-Tru door means designing an inspired entrance with the confidence that it will perform for years to come.



**Uncompromising quality,  
inside and out.**

#### **FIND YOUR FAVORITE DOORS**

Throughout the catalog you'll find doors organized by glass shape (largest to smallest), followed by glass design, and then texture.

## Table of Contents

<b>Introduction</b> .....	2-27
<b>NEW</b> Products .....	4-9
Therma-Tru® Thrive .....	10-11
Curb Appeal .....	12
Door Selections .....	13-15
Door System Components .....	16-17
Tru-Defense® .....	18-19
Safety & Security.....	20-21
Decorative & Specialty Glass .....	22-25
Impact-Rated Products .....	26-27
<b>Patio, Storm &amp; Vent</b> .....	28-33
Hinged Patio Door Systems .....	28-29
Retractable Screen Doors .....	30-31
Impressions™ Integrated Storm & Entry Door System .....	32-33
<b>Veris Collection Overview</b> .....	34-43
<b>Classic Craft®</b> .....	44-107
Decorative & Specialty Glass .....	52-59
Accessories .....	60-61
Hinged Patio Doors .....	104-107
<b>Fiber-Classic® &amp; Smooth-Star®</b> .....	108-215
Decorative & Specialty Glass .....	114-121
Accessories .....	122
Hinged Patio Doors .....	210-215
<b>Steel</b> .....	216-239
Profiles™ .....	218, 221-233
Traditions .....	218, 234-239
Decorative & Specialty Glass .....	219-220
<b>Fire Doors</b> .....	240-243
<b>Pulse®</b> .....	244-257
<b>Finish Options</b> .....	258-264
PrismaGuard® Stain & Paint .....	258-263
Same-Day® Stain Kit .....	264
<b>Door System Components</b> .....	265-279
<b>Special Quote Program</b> .....	280
<b>3'6" Width Options Chart</b> .....	281
<b>7'0" &amp; 6'6" Height Options Charts</b> .....	282-283
<b>Product Details</b> .....	284-285
<b>Index</b> .....	286-298
<b>Trade Resources</b> .....	299

# NEW Flush-Glazed Half-Lite 1-Panel Shaker Doors & Sidelites for Smooth-Star® Doors



## Classic Shaker-style charm.

Capture the beautiful simplicity of Shaker style with half-lite 1-panel Shaker doors and sidelites with flush-glazed glass. Available with privacy and textured, energy-efficient Low-E glass and divided lite styles.

Available in Smooth-Star, starting on page 133.

**7'0" sizes available Q3 2024.**



Residential



Multi-Family / Commercial



### EnLiten™ Flush-Glazed Warranty Riders

See page 123 for details on the EnLiten Flush-Glazed Rider for Construction & Installation, and the EnLiten Flush-Glazed Rider for Homeowners.

Note: Smooth-Star products used in multi-family or commercial settings are backed by a 3-year limited warranty. See your Therma-Tru seller or visit [thermatru.com](http://thermatru.com) for details on available product sizes and options, limited warranties and exclusions, Riders and ENERGY STAR qualified products.

# NEW Door Divider Bar (DDB) & Simulated Divided Lite (SDL) Styles for Smooth-Star® Doors

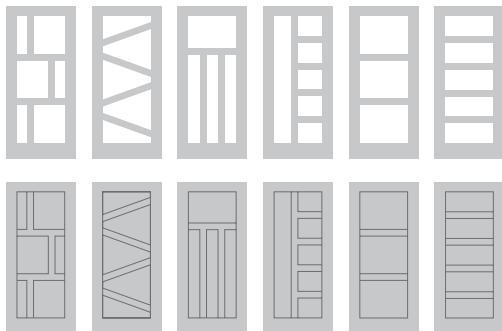

## On-trend design, timeless style.

Discover new ways to bring popular Shaker charm to the entry. New DDB and SDL styles for flush-glazed full-lite and solid-panel Shaker-style doors blend on-trend contours with purposeful Shaker design to complete the look of Contemporary and Modern home styles.

Available in Smooth-Star, starting on page 126.



### EnLiten™ Flush-Glazed Warranty Riders

See page 123 for details on the EnLiten Flush-Glazed Rider for Construction & Installation, and the EnLiten Flush-Glazed Rider for Homeowners.

Note: Smooth-Star products used in multi-family or commercial settings are backed by a 3-year limited warranty. See your Therma-Tru seller or visit [thermatru.com](http://thermatru.com) for details on available product sizes and options, limited warranties and exclusions, Riders and ENERGY STAR qualified products.

Top: Smooth-Star Door - S5701; Satin Etch Glass, Sidelite - S2000XESL, Finish - Elk

# NEW Impact-Rated Full-Lite Flush-Glazed Glass Designs for Smooth-Star® Doors

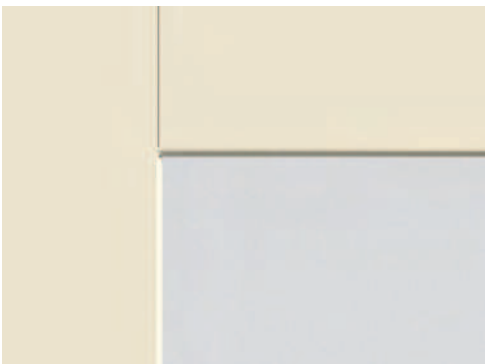

## More light along the coast.

Enjoy the clean style and increased daylight opening of full-lite EnLiten™ flush-glazed glass, now engineered to withstand extreme weather conditions.\* Available with privacy and textured, energy-efficient Low-E glass and a wide selection of simulated divided lite styles.

Available in Smooth-Star, starting on page 128.

**Available Q3 2024.**



Residential



Multi-Family / Commercial



WBDR Options\*\*

### EnLiten™ Flush-Glazed Warranty Riders

See page 123 for details on the EnLiten Flush-Glazed Rider for Construction & Installation, and the EnLiten Flush-Glazed Rider for Homeowners.

\*Product approvals show that the door system meets applicable codes when selected, assembled and installed as instructed.

\*\*Must be installed as part of a Therma-Tru door system in compliance with a Therma-Tru Impact-rated product approval.

Note: See your Therma-Tru seller or visit [thermatru.com](http://thermatru.com) for product approvals and installation instructions, details on available product sizes and options, limited warranties and exclusions, Riders and ENERGY STAR qualified products. Always confirm building code requirements in your area before buying. Follow weather and news reports to assess severe weather situations and obey local authorities' shelter and evacuation orders. No product guarantees safety for persons or property, nor makes any premises hurricane- or impact-proof.

# Advanta® Lite Frame\*\*\*

for Fiber-Classic®, Smooth-Star®, Profiles™, Traditions & Pulse®.



**ADVANTA**  
LITE FRAME



The Advanta lite frame is a patented design, U.S. Patent No. 10,655,382.

Four-piece design includes two interchangeable frame covers and a two-piece base frame.

## A new frame of mind.

Achieve a seamless look with the Advanta lite frame, an innovative, patented solution from Therma-Tru. Avoid the unsightly look of missing screw plugs and enhance the beauty of your home's entryway.

Available in scrolled and flat frame options for Fiber-Classic and Smooth-Star, starting on page 139; Profiles and Traditions, starting on page 221; and Pulse, starting on page 248.

## AVAILABLE LITE FRAME SIZES

Fiber-Classic® / Smooth-Star® / Profiles™ / Traditions / Pulse®.



## AVAILABLE GLASS OPTIONS

Glass options vary by size.

- Decorative Glass
- Privacy & Textured
- Internal Blinds
- Divided Lites
- Clear / Low-E

 Fiber-Classic, Smooth-Star, Pulse Fiberglass	 Profiles, Traditions, Pulse Steel	
---	---	---

\*\*\*See your Therma-Tru seller for details on product availability.  
Note: See your Therma-Tru seller or visit [thermatru.com](http://thermatru.com) for details on available product sizes and options, and limited warranties and exclusions.

# NEW 8'0" Smooth-Star® Doors & Sidelites

## with Elevated Bottom Rail

Therma-Tru® Doors



### Classic style – elevated.

Our assortment of popular Smooth-Star doors and sidelites expands to include new elevated bottom rail options. The new flush-glazed full-lite sidelite features a 10" bottom rail to match doors with elevated bottom rails for a consistent look across the door system. The new 8'0" 2-panel square top Shaker-style door offers new ways to bring transitional style to tall entries.

Available in Smooth-Star, starting on page 207.

**Door available Q3 2024.**



Residential



Multi-Family / Commercial



Fire-Rated Options

Minimum 10" Bottom Rail



8'0" 2-Panel Square Top Shaker Door



8'0" Flush-Glazed Full-Lite Sidelite

Note: Smooth-Star products used in multi-family or commercial settings are backed by a 3-year limited warranty. See your Therma-Tru seller or visit [thermatru.com](http://thermatru.com) for details on product sizes and options, limited warranties and exclusions, Riders and ENERGY STAR qualified products.



# NEW 8'0" Smooth-Star® Flush-Glazed Doors with Internal Blinds & Elevated Bottom Rail



## More natural light. No compromises.

A durable, on-trend solution for multi-family dwellings, the 8'0" Smooth-Star flush-glazed full-lite door with internal blinds delivers privacy and convenience. Now with an elevated bottom rail to meet ADA applications\*\*, this door is ideal for the patio and back of the home.

Available in Smooth-Star, starting on page 126.



Residential



Multi-Family / Commercial

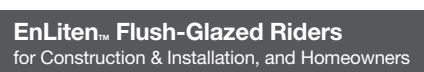

8'0" Flush-Glazed Full-Lite Door

Elevated Bottom Rail  
U1: 10-1/4"  
Book / Hybrid: 10-15/32"

\*\*For ADA compliance, door must be 3'0" wide.

Note: Smooth-Star products used in multi-family or commercial settings are backed by a 3-year limited warranty. See your Therma-Tru seller or visit [thermatru.com](http://thermatru.com) for details on available product sizes and options, limited warranties and exclusions, Riders, ENERGY STAR qualified products, product approvals and installation instructions. Please verify that there is a Therma-Tru product approval for the configuration before buying.

Top: Smooth-Star, Internal Blinds, Doors - S82600, Finish - Alpine

# Together, let's make a world of difference.

We're doing our part to build a better world, every chance we get. Therma-Tru® Thrive is our commitment to make safe and sustainable products, support the communities where we live and work, and leave a positive, lasting impact on the environment.

**THERMA TRU**  
THRIVE™

## Making life better at home.

Our complete door systems are built to help protect against energy loss and break-ins, helping people stay safe and comfortable at home.

Fiberglass doors have up to four times the insulating R-Value of wood\*. Ours feature a polyurethane foam core, an **energy-efficient insulating material**.

5+ years on the leading edge of the industry, **reducing harmful chemicals** from our PrismaGuard® paints and stains.

Our door systems are **tested for 300 lbs. of forced-entry resistance**. (AAMA 1304)



## Helping take care of our planet.

Across all our facilities, we're finding innovative ways to reuse waste materials and expand our recycling efforts.

Therma-Tru is proud to be **recognized as the 2023 Brand Leader\*\*** by *Green Builder* magazine for offering durable, well-insulated products.

More than 50% of our fiberglass and steel door end rails are made from **over 90% recycled or scrap material**.

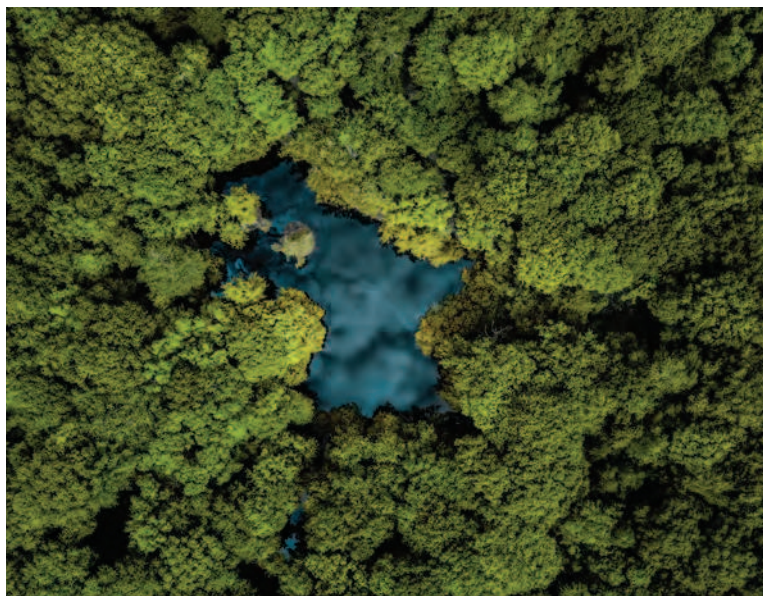

## Being a good neighbor.

For over 40 years, we've been proud to partner with 100+ local and national organizations to make a positive impact on the places we all call home.

**Building homes** for those in need with Habitat for Humanity.

**Providing entryways** for our nation's wounded vets with Jared Allen's Homes for Wounded Warriors.

**Hosting blood and donation drives** to support the American Red Cross.



\*Comparison of fiberglass to wood doors (both without glass).  
\*\*Brand Index, 2023 *Green Builder* magazine.

# Make a Smart Investment

Therma-Tru® Doors



After

## Make a great first impression.

A front door is nearly impossible to ignore when walking into a home, and for potential homebuyers, first impressions are critical. How attractive a home is from the exterior tends to set expectations for the interior and beyond.

In fact, in a recent survey, **44% of homeowners said they were more likely to purchase a home with an enhanced entry**, and one in three homeowners said they were willing to pay a premium for one.\*



**One in three** homeowners said they were willing to pay a premium for an enhanced entry.\*

\*Not a guarantee of investment returns, increase in value or selling price. See 2021 Therma-Tru National Home Valuation Study surveying real estate agents about perceived remodeled home value estimates based on exterior appearance. Not based on actual home sales data. Results may vary based on region, door style and home style. Study was commissioned by Therma-Tru and conducted by the Farnsworth Group, an independent research provider.

\*\*Manufacturer's Test Facility Quality Assurance Validation Program, Architectural Testing, Inc.

Note: See your Therma-Tru seller or visit [thermatru.com](http://thermatru.com) for details on available product sizes and options, limited warranties and exclusions, and installation instructions.

# The Beauty of Choice

The architectural beauty of a Therma-Tru® door is easy to see. With the look of real wood, rich panel details and intricate, handcrafted decorative glass designs, there are thousands of possibilities to suit the style of a home and express a homeowner's personal style.

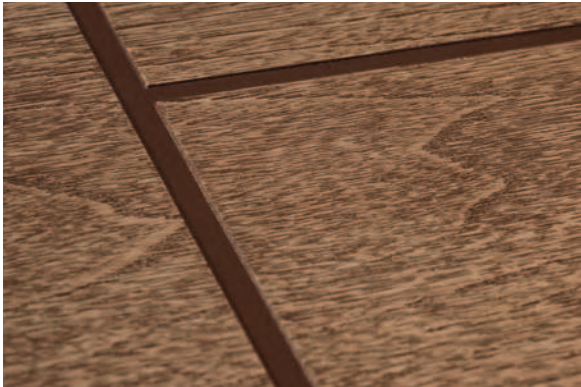

## DOOR SELECTIONS

Find choices in design, texture and material with many configurations available to find the ideal door system. More on pages 14-15.

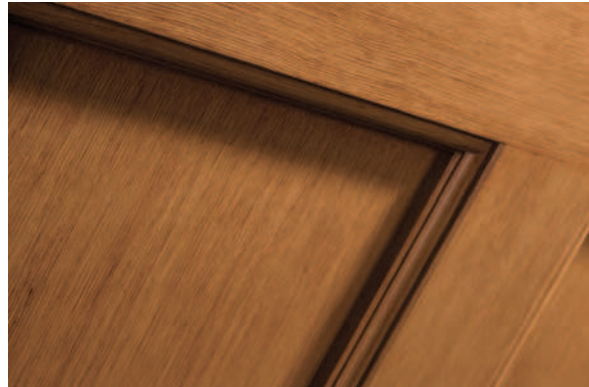

## FINISH OPTIONS

Complete the desired look with stain or paint. Explore a variety of colors from PrismaGuard® premium finish and Same-Day® stain on pages 258-264.



## DECORATIVE & SPECIALTY GLASS

Complement any Therma-Tru door with a variety of glass shapes and designs. More on pages 22-25.



## DOOR SYSTEM COMPONENTS

Have confidence in a door system made with genuine Therma-Tru components to meet the needs of many applications. More on pages 16-21.

# Designed for peace of mind.

## LIFETIME LIMITED WARRANTIES

We stand behind more parts and for longer than most other door companies because we make or specify everything that goes into our door system. A Therma-Tru fiberglass door system is backed by our comprehensive lifetime limited warranties.



## QUALITY TESTING

Our doors, glass and components undergo thorough testing to help ensure they will live up to a homeowner's toughest quality and performance expectations.

We even have our own engineering lab – approved to perform specific test methods with a third-party witness\*\* – as part of our ongoing commitment to ensuring that our products live up to our high standards for durability and reliability.

# Door Selections

Choose from our many door selections to complement the architectural style of the home from the front entry to the back patio. The possibilities are endless from fiberglass and steel materials to wood-grained and smooth textures to stainable and paintable finishes.

## The Classic Craft® Series Pages 44-107

Revel in the handcrafted look and feel of a premium fiberglass entryway with true-to-wood origins. Discover exquisite textures with grains hand-selected from the finest natural wood species and meticulously recreated with our revolutionary AccuGrain® technology.



**Fir Grain**  
Formerly Classic-Craft American Style



**Walnut Grain**



**Mahogany Grain**  
Formerly Classic-Craft Mahogany & Rustic



**Canvas**

Note: Finish colors may vary from an actual application due to fluctuations in finishing or printing. See your Therma-Tru seller or visit [thermatru.com](http://thermatru.com) for details on limited warranties and exclusions.

Bottom: Classic Craft Mahogany Grain, Low-E Glass with SDLs, Doors – CCM8306CAL, CCM8306CAR, Finish – Driftwood

# Fiber-Classic® Collections Pages 108–215

The industry's first fiberglass door delivers the look and feel of real Mahogany and Oak with excellent performance and value.



**Mahogany Collection™**



**Oak Collection™**



# Smooth-Star® Pages 108–215

A smooth, ready-to-paint fiberglass door that offers excellent performance and value.

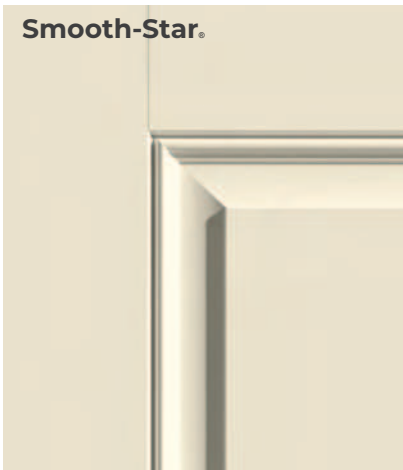

**Smooth-Star.**



# Steel Pages 216–239

Bring style and affordability together to create very attractive results with our steel doors.



**Profiles™**  
**10 YEAR LIMITED WARRANTY**  
 Door & Glass

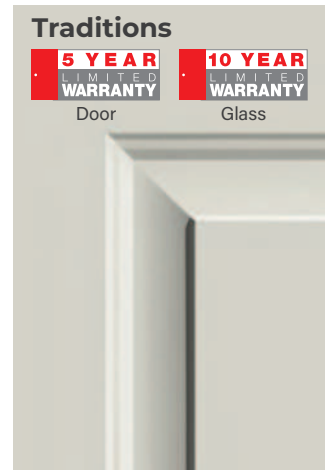

**Traditions**  
**5 YEAR LIMITED WARRANTY** (Door)  
**10 YEAR LIMITED WARRANTY** (Glass)

# Pulse® Pages 244–257

A contemporary series of door styles and glass designs that can be combined to make a bold statement.



**Ari**



**Línea**



**Echo**

# Engineered to Work Together

Our complete door systems feature doors, glass and components engineered to work together to resist leaks and drafts, and help maintain energy efficiency and weather resistance.





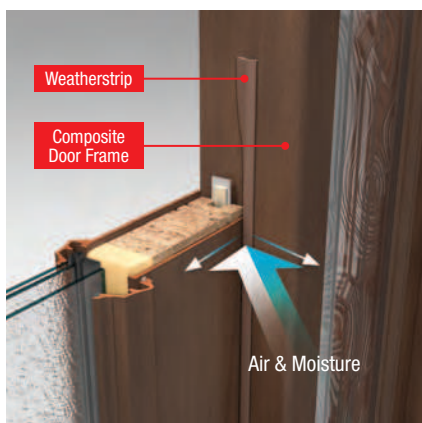

- 1 Weatherstrip** is engineered in a variety of profiles to provide the best possible fit with our door systems, helping to deliver a precise seal between the **door** and **frame**. In addition, a rot-free Therma-Tru **composite door frame\*** delivers extra protection from the damaging effects of moisture.

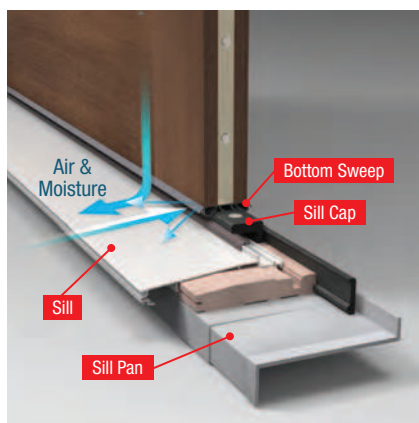

- 2 Sill and bottom sweep** form a tight seal against wind-driven moisture infiltration at the bottom of the door system and help channel moisture away from the home. **Sill pan** (recommended) adds an extra layer of protection to help keep moisture away from the subfloor.

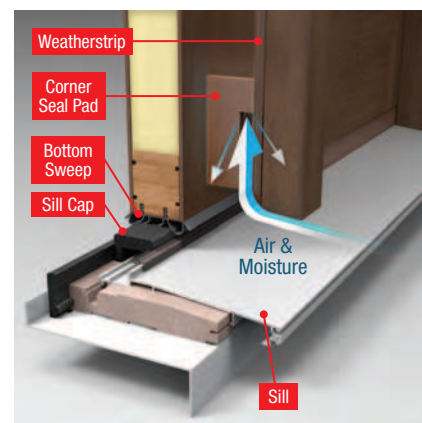

- 3 Corner seal pads** (inswing only) complete the seal between the **sill cap, bottom sweep** and **weatherstrip** to help block potential pathways where wind-driven moisture can infiltrate the bottom corner of the door system.

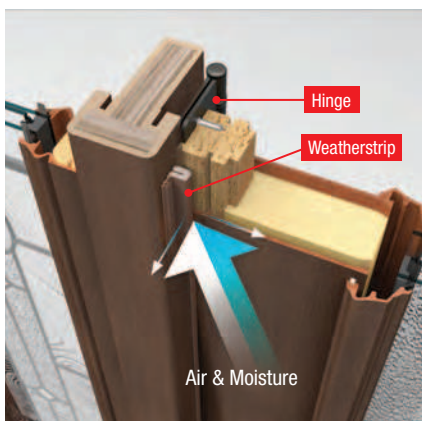

- 4 Hinges** position the **door** to properly compress the **weatherstrip** to help form a tight, even seal against air and moisture infiltration when the door closes.

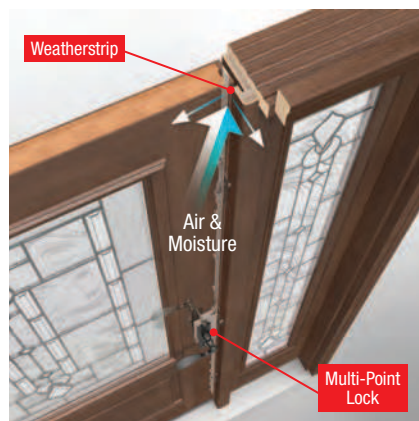

- 5 Multi-point locking system** (recommended) engages the door and frame at three points from top to bottom for enhanced security while helping to preserve the **weatherstrip's** seal even under wind pressure.

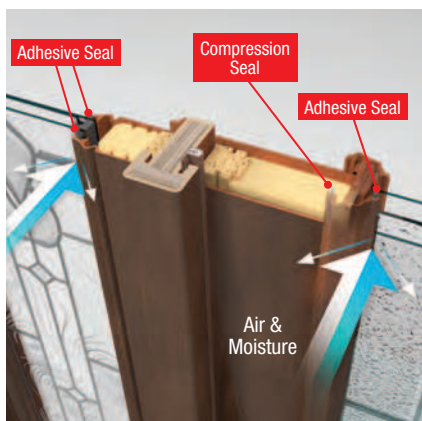

- 6 Lip-lite frame** (shown right) features a **compression seal** against weather on the outside of the **door** and an **adhesive seal** against weather on the outside of the **glass**. **Flush-glazed glass** (shown left) is built directly into the door without a Lip-lite frame, featuring a **high-performance adhesive weather seal** inside and out.

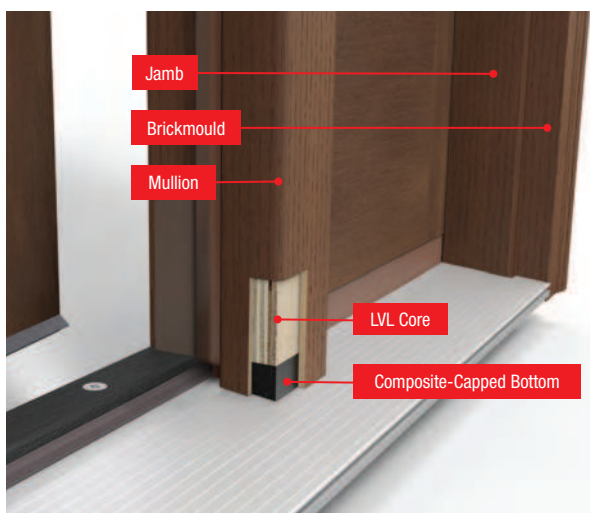

## Composite Door Frame\*

featuring Tru-Guard™ Composite Technology

Therma-Tru® composite door frame featuring Tru-Guard composite technology provides a rot-free solution engineered to work together with rot-resistant Therma-Tru doors and components.

**TRU**  **GUARD**  
COMPOSITE TECHNOLOGY

# Tru-Defense® Warranty Rider

A Therma-Tru® door system with Tru-Defense system components is a high-performing door system backed by a lifetime limited warranty and a comprehensive Tru-Defense Warranty Rider.



## Tru-Defense: The Ultimate Protection

More than beautiful doors and glass, a complete door system includes the components used to assemble it. We manufacture or specify every aspect of a complete door system. The Therma-Tru genuine components in a Tru-Defense door system are our premium options for long-lasting durability.

### DOUBLE YOUR PEACE OF MIND

When it comes to door systems, we believe that proper installation is just as important as having the best components. A Tru-Defense door system installed by a Therma-Tru Certified Door System Installer doubles your reimbursement eligibility should an issue arise.\* Look for the  icon.

**CERTIFIED**  
DOOR SYSTEM  
**INSTALLER**

**THERMA-TRU®**  
DOORS

\*The Rider does not warrant workmanship of anyone who assembles or installs a Tru-Defense door system, including Therma-Tru Certified Door System Installers, nor any damages caused by improper handling, assembly or installation.

\*\*Latch and deadbolt must meet Therma-Tru specifications.

Note: See your Therma-Tru seller or visit [thermatru.com](http://thermatru.com) for details on limited warranties and exclusions.

Top: Classic Craft Canvas, Provincial Glass, Door - CCV10028, Sidelites - CCV108SL, Transom - CC420T, Finish - Chestnut

# Required Components for Tru-Defense Door System

with Therma-Tru Fiberglass Door Slab & Components



## DOOR FRAME ❖

Provides a solid structure for the door slab and components. Recommended: Therma-Tru Composite Door Frame



## CORNER SEAL PADS ❖ (Inswing Only)

Fit securely behind the weatherstrip to help block wind-driven moisture infiltration at the bottom corner of the door system.



## COMPOSITE ADJUSTABLE SILL ❖

Provides a solid stepping surface and forms a tight seal at the bottom of the door system to help channel moisture away from the home.



## WEATHERSTRIP ❖

Features a resilient design to help deliver a precise seal between the door and frame.



## BOTTOM SWEEP ❖ (Inswing Only)

A dual-bulb, dual-fin design helps maintain tight contact with adjustable sill caps and creates added barriers against moisture.



## ASTRAGAL ❖ (Double Doors)

Covers the margin between double doors to help complete the seal against air and moisture infiltration, with aluminum construction for stability, holding power and durability.



## HINGES ❖

Ensure smooth operation and position the door so it creates a tight seal with the weatherstrip when closed.



## RAIN GUARD ❖ (Outswing Only)

Creates a barrier at the top of the door to protect against moisture infiltration.

## Recommended Components



## MULTI-POINT LOCKING SYSTEM ❖ (MPLS)

Engages the door and frame at three points from top to bottom for enhanced security and sealing.

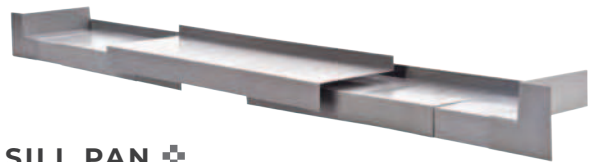

## SILL PAN ❖

Adds an extra layer of protection to help keep moisture away from the subfloor; protects flooring by catching and draining water in the event of infiltration.

### Levels of Reimbursement

System Components	Reimbursement Eligibility	Reimbursement Eligibility with a Certified Installer
Latch & Deadbolt (No Sill Pan)**	\$250	\$500
Latch & Deadbolt with Sill Pan**	\$500	\$1,000
MPLS (No Sill Pan)	\$1,000	\$2,000
MPLS with Sill Pan	\$1,250	\$2,500

Baseline components required to qualify for the Tru-Defense Warranty Rider.

# Fiberglass Door Systems Built for Safety & Security

Protect the home and everything in it, from family and pets to valuables and keepsakes. Therma-Tru products are designed for durability and enhanced security with pieces and parts engineered as a complete system.

## Did you know?



**On average, a home is burglarized in the U.S. every 45 seconds.<sup>1</sup>**

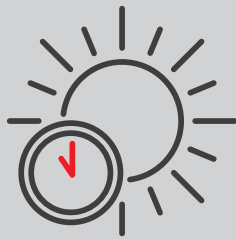

**More than half of home burglaries occur during the daytime.<sup>2</sup>**

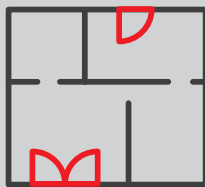

**How do burglars enter the home?**

**34% Front Door<sup>3</sup>  
22% Back Door<sup>3</sup>**

## THERMA-TRU® COMPOSITE DOOR FRAME

More reliable and up to 50% stronger on average than standard wood door frames when withstanding a simulated forced entry attempt by kicking in the door.\*

- Features full-length jambs with no finger joints for more reliable performance, and a continuous composite material that will not deteriorate over time, like wood.
- Entries with a wooden door frame are more susceptible to being kicked in as compared to a Therma-Tru composite door frame, giving burglars access to your home within seconds.
- Wood jambs typically have finger joints. These areas where two pieces of wood come together are structurally weaker when compared to a single continuous material that runs the entire length of the jamb.



**Scan to see our products put to the test.**



**Therma-Tru Wood Jamb**



**Therma-Tru Composite Jamb**

\*Comparison of pendulum impact test results for Therma-Tru composite door frame and standard finger-jointed Pine wood door frame, both with similar pre-hung doors.

\*\*Comparison of pendulum impact test results for Therma-Tru doors in steel versus fiberglass. Visit [thermatru.com](http://thermatru.com) for details.

<sup>1</sup>Source: FBI Uniform Crime Reporting Program, "2019 Crime in the United States."

<sup>2</sup>Source: FBI Uniform Crime Reporting Program, "2019 Crime in the United States," Table 7.

<sup>3</sup>Source: [asecurelife.com](http://asecurelife.com)

## THERMA-TRU FIBERGLASS DOOR SLAB

Up to 30% more resistant to kick-ins than standard steel doors.\*\*

Features durable construction that can withstand impact by absorbing and deflecting the force.\*\*

- Built with enhanced lock blocks to help ensure proper handleset reinforcement, combined with lock and hinge stiles that increase rigidity and stability.
- Will not dent or rust, nor will it warp, split, crack or rot.

## THERMA-TRU GLASS

- Options feature double- or triple-pane construction and include two panes of tempered glass for enhanced safety and performance.



Pendulum Impact Test

## Material Myths: Think steel is stronger? Think again.

- While many people assume steel doors are the most secure against forced entry, Therma-Tru fiberglass doors are up to 30% more resistant to kick-ins than standard steel doors.\*\*
- Standard steel doors can dent and bow, which leads more quickly to product failure. Therma-Tru fiberglass doors feature durable construction that can withstand impact by absorbing and deflecting the force.\*\*
- Wood doors and steel doors may weaken over time with exposure to the elements.

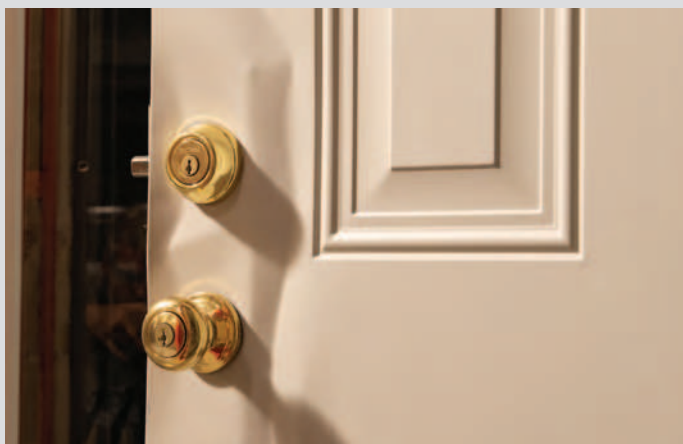

## Decorative & Specialty Glass

A Therma-Tru® door system with decorative glass can create an entrance that makes a statement — one that says the homeowner has high standards for style, quality and craftsmanship.

- Our wide array of glass designs, from simple to intricate, reflect the home design trends and homeowner desires of today and tomorrow.
- Our glass designs are researched in the market to ensure they are highly rated in consumer preference.
- Our decorative glass is handcrafted and built with all-glass bevels for premium quality.
- Numerous glass colors, textures, shapes and coming options are available to complement any door.
- All Low-E and clear glass panels are tempered or laminated to provide added safety.

Note: See your Therma-Tru seller or visit [thermatru.com](http://thermatru.com) for details on ENERGY STAR qualified products.



Contributes to an energy-efficient home.



## Internal Blinds

Enjoy the privacy and convenience of a cordless blind enclosed between glass. Control the desired level of light and privacy with the simplicity of a single handle.

- Protected between two panes of tempered glass for enhanced safety and performance.
- With no dangling cords, this is a kid- and pet-friendly choice.
- Blinds remain dust free, and glass is easier to clean than traditional blinds.
- Available options include Low-E glass for energy efficiency, EnLiten™ flush-glazed designs and Impact-rated options.

**Available in Fiber-Classic®, Smooth-Star®, Profiles™ and Traditions doors and sidelites.**

## TRIPLE-PANE CONSTRUCTION

All triple-pane decorative, as well as privacy and textured, glass panels are enclosed between tempered glass, offering superior quality and thermal performance.

Right Page: Smooth-Star, Clear Glass with SDLs,  
Door – S6042, Finish – Alpine

## Privacy & Textured Glass

Therma-Tru doors and sidelites can be fitted with our beautiful privacy and textured glass. This versatile assortment aligns with personal style and homeowner desires for privacy while allowing natural light to brighten the interior.

- All privacy and textured glass options are triple-pane, providing thermal efficiency.
- Triple-pane construction also allows for an easy-to-clean surface.
- Available with two Lip-lite frame options, as well as seamless flush-glazed options, in select doors.

**Available in Classic Craft<sup>®</sup>, Fiber-Classic<sup>®</sup>, Smooth-Star<sup>®</sup>, Profiles<sup>™</sup>, Traditions and Pulse. doors and sidelites.**



## Low-E Glass

Factory-coated Low-E glass delivers exceptional energy efficiency. Available in Classic Craft, Fiber-Classic, Smooth-Star, Profiles, Traditions and Pulse. Look for the (☀️) icon.



## Divided Lites



Enhance the beauty of any home with a variety of divided lite options for entry and patio doors. Tailor the look with different texture, profile, width and color choices.

- Coordinate with the home's window patterns and architectural details for a cohesive look and increased curb appeal.
- Available divided lite options include simulated divided lites (SDLs), grilles between glass (GBGs) and fixed grilles.
- Available glass options include elegant privacy and textured, as well as energy-efficient Low-E and clear glass.

**Available in Classic Craft<sup>®</sup>, Fiber-Classic<sup>®</sup>, Smooth-Star<sup>®</sup>, Profiles<sup>™</sup> and Traditions.**

# EnLiten™ Flush-Glazed Designs

## for Classic Craft®, Fiber-Classic® & Smooth-Star® Doors & Sidelites

Simplified beauty. Resilient designs. With clean lines and seamless construction, EnLiten flush-glazed designs are perfect for today's homes. Built for long-term performance, these doors and sidelites feature the sleek looks homeowners want and the stylish around-the-home solutions they need. Look for the (   ) icons.

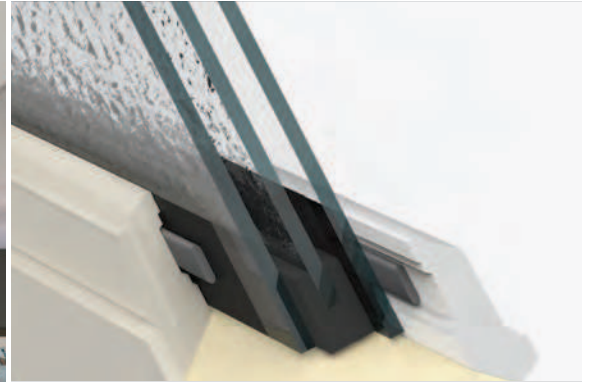

### STRENGTH IS BUILT IN

Our doors are durable by design. Flush-glazed glass represents a trouble-free solution that provides a superior barrier against the elements, resulting in performance you can depend on.



\*Comparison of U-factor values of a flush-glazed full-lite door and a Lip-lite full-lite door, both with Low-E glass.

\*\*Must be installed as part of a Therma-Tru door system in compliance with a Therma-Tru product approval. Check product approvals before purchasing.

Note: See your Therma-Tru seller or visit [thermatru.com](http://thermatru.com) for details on available product sizes and options, limited warranties and exclusions, and Riders.

Left Page Top Left: Classic Craft Fir Grain, Satin Etch Glass with SDLs, Doors - CCA82320XE, Finish - Raven

Left Page Bottom Left: Smooth-Star, Chinchilla Glass with SDLs, Door - S2104XJ, Finish - Granite

Left Page Bottom Right: Smooth-Star, Internal Blinds, Doors - S2600

Right Page: Smooth-Star, Granite Glass with SDLs, Door - S83400XN, Sidelites - S85225XNSL, Finish - Peregrine





## DURABLE BY DESIGN

Double- or triple-pane glass is built directly into the door with a high-performance dual adhesive weather seal. This delivers a clean seamless look with no lite frame or screw plugs, and reduces the potential for air and water infiltration, among other benefits.



### Superior Sound Dampening

Doors with flush-glazed glass do a better job of dampening outside noise compared to a Lip-lite alternative.



### 11% More Energy Efficient

The Low-E glass used in flush-glazed doors delivers a clear view and is 11% more energy efficient than 1/2" Low-E glass in a Lip-lite frame.\*



### Withstands Winds Up to 167 mph

Door systems with flush-glazed glass are designed and tested to withstand wind forces up to 167 mph (DP-50).\*\* (ASTM-E330)

## EnLiten™ Flush-Glazed Warranty Riders

for Construction & Installation, and Homeowners. See page 123 for details.

# Tough when you need it. Beautiful always.

## High-Power Testing

Our Impact-rated doors pass a large missile impact test. We blast a 9 lb. 2" x 4" stud into the doors at 34 mph to prove they're the better choice for strength and stability.

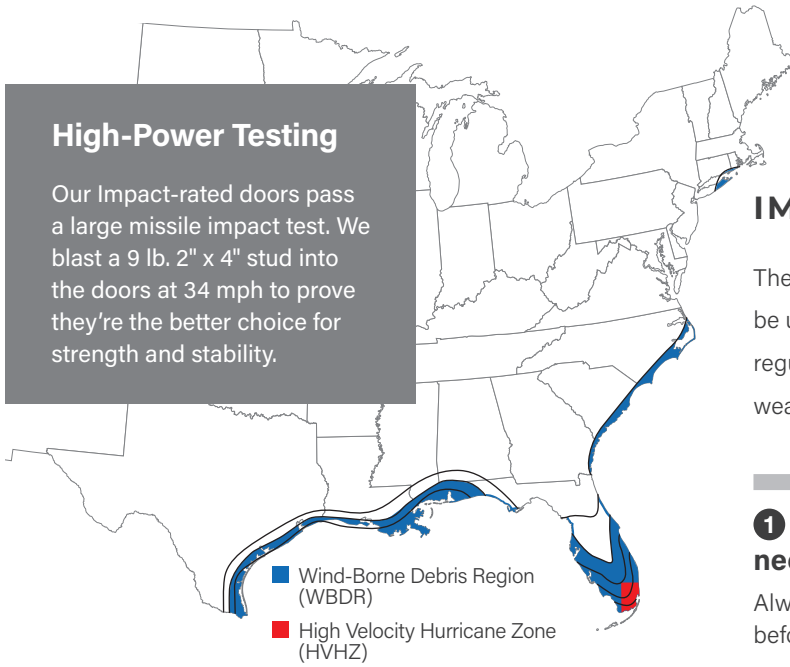

## IMPACT-RATED PRODUCTS

Therma-Tru offers Impact-rated doors and glass that can be used to meet high-wind and coastal region codes and regulations, offering excellent performance in extreme weather conditions while providing added protection.

### 1 Use the map as a guide to find out if you need product for WBDR or HVHZ.

Always confirm building code requirements in your area before buying.\*

### 2 Use the icons to find available Therma-Tru® product options in this catalog.

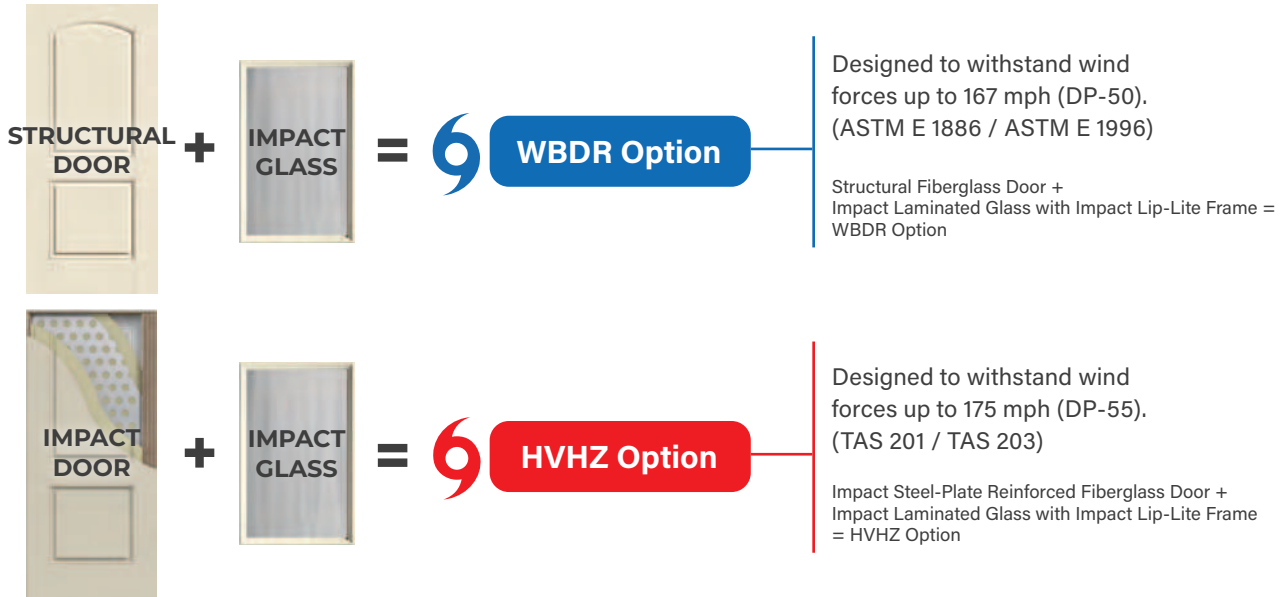

 **WBDR / HVHZ Options:** Look for this icon to find door and sidelite styles that can be configured for WBDR or HVHZ.

### 3 Verify that there is a Therma-Tru product approval specific to your area for the door system configuration before buying.\*

### 4 Make sure the product is installed in compliance with the product approval to meet building codes.

The performance of the door system depends on how it is installed. Proper installation is required to comply with building codes.

\*Product approvals show that the door system meets applicable codes when selected, assembled and installed as instructed. Note: See your Therma-Tru seller or visit [thermatru.com](http://thermatru.com) for product approvals and installation instructions. Always confirm building code requirements in your area before buying. Follow weather and news reports to assess severe weather situations and obey local authorities' shelter and evacuation orders. No product guarantees safety for persons or property, nor makes any premises hurricane- or impact-proof.

Constructed to help protect the interior of the home from flying debris and high winds associated with tropical storms and hurricanes, these products are tested to meet codes and regulations in coastal regions, including parts of Florida, Texas and the Carolinas.\*

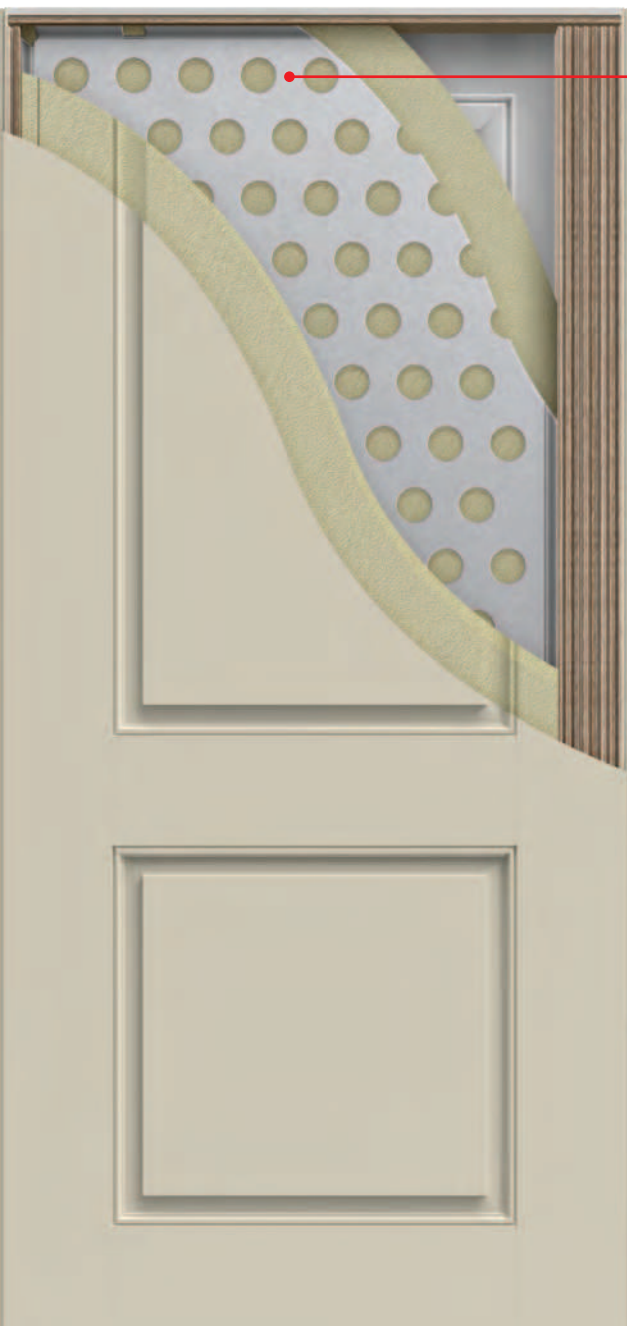

### IMPACT DOORS

Feature a built-in 24-gauge steel plate lining.

### NEW IMPACT FLUSH-GLAZED GLASS

Offers clean style and an increased daylight opening.

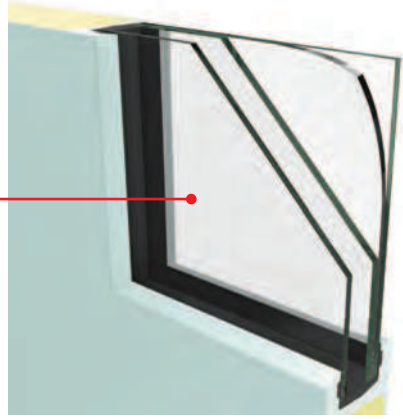

### IMPACT GLASS

Features special laminated glass construction.

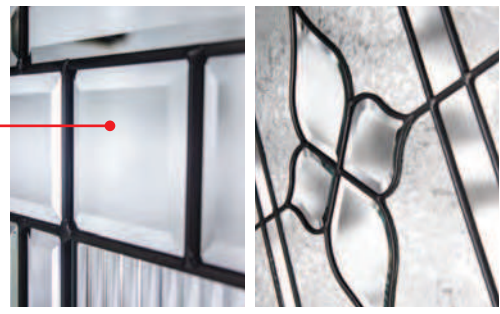

### IMPACT INTERNAL BLINDS

Features laminated glass construction and a durable, paintable aluminum lite frame with a flat profile aesthetic cover for a simple look.



### OTHER CONSIDERATIONS

**Fire Doors**  
See pages 240–243.

**Noise Reduction Doors**  
See page 205.

**Elevated 10" Bottom Rail**  
Look for the (E) symbol.

### IMPACT LIP-LITE FRAME

Features durable, paintable aluminum construction. An attractive scrolled profile gives a thin, sleek appearance and a screw channel cover helps hide unsightly screws.

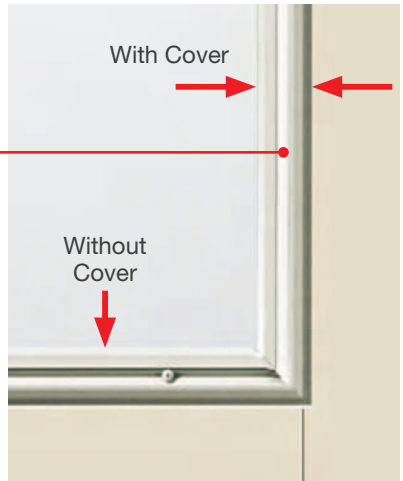

# Hinged Patio Door Systems



## Simply beautiful, any way you see it.

Extend the beauty and quality of a Therma-Tru® entrance to the back of the home with hinged patio doors. Find style and convenience that's unsurpassed from any view with options to control the level of privacy and light, complement window patterns, and let fresh air into the home.

Note: See page 285 for important product details that may help with your purchase decision.

Top: Fiber-Classic Oak Collection, Clear Glass, Doors - 8000, Finish - Driftwood  
Bottom: Smooth-Star, Clear Glass, Doors - S2000

A Therma-Tru® patio door with genuine Therma-Tru components is a complete door system with doors, glass and components engineered to work together for durability and reliability through the years.

Interior view of door.



- 1 Multi-Point Locking System (Recommended)
- 2 Bottom Sweep
- 3 Sill
- 4 Hinges
- 5 Corner Seal Pads (Inswing Only)
- 6 Sill Pan (Recommended)
- 7 Frame Components
- 8 Multi-Point Locking System (Included)
- 9 Removable Screens

**VENTED SIDELITES**

Enjoy the view - and a fresh breeze, too.

- Constructed to provide ventilation without sliding screens blocking the view, vented sidelites work as small swinging doors with convenient removable screens — available in bronze and white.
- Engineered for durability and safety with wide patio mullions for strength, and multi-point locking gears and recessed strike plates for security.

Look for the (●) symbol.

**Available Configurations**



Single Door with Vented Sidelites (Inswing Only)



Double Doors with Vented Sidelites (Inswing Only)

**PATIO TRANSOMS**

Transoms can be stained or painted to match a Fiber-Classic® or Smooth-Star® door system.

Available for 5'0", 5'4", 5'8" and 6'0" patio openings.

Note: Patio transoms are designed for door systems with a mullion.

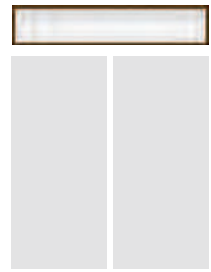

19250T

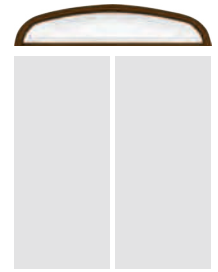

19050T

Classic Craft, starting on page 104.  
 Fiber-Classic, Smooth-Star, Profiles & Traditions, starting on page 210.

# Retractable Screen Doors

Welcome fresh air and natural light into the home while keeping debris and insects out. Therma-Tru retractable screen doors feature a discreet, hidden design that helps provide a seamless transition from indoors to out. Plus, it's been quality tested for compatibility with Therma-Tru entry door systems.

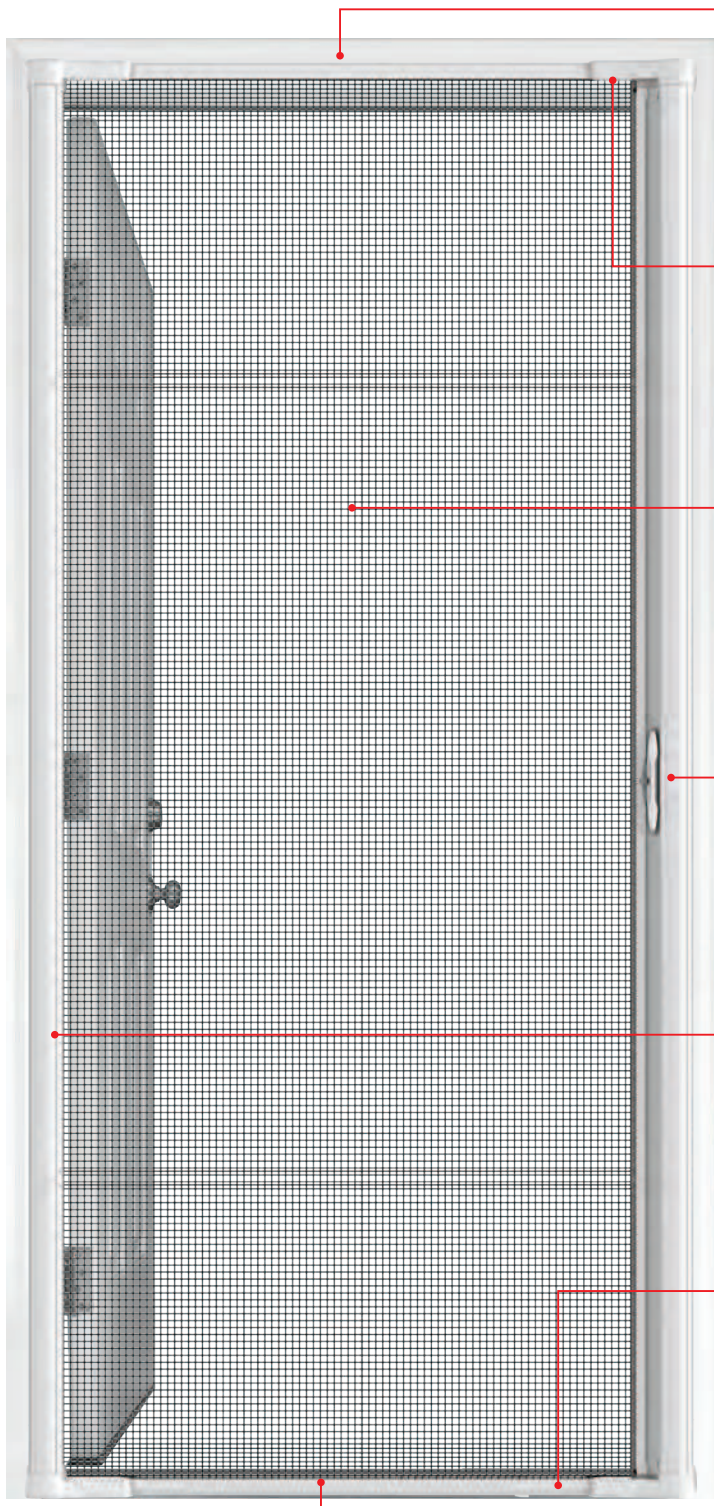

**Face mount installation** allows for an easier install while providing a full pass-through space without an intrusive cassette or track.

**E-Z Glide System** enables smooth screen retraction and extension without slamming.

**Fiberglass screen mesh** fully retracts when not in use.

**One-hand operation** with a secure and ergonomic latch / lock handle.

**Rust-proof aluminum** housing and track for strength and beauty.

**Quick-Snap Track** adjusts to required length in seconds – no cutting required.\*

**Universal sill plate** designed for simple and secure fit.

\*Adjusts quickly for 32"-36" doors. If less than 32", a hacksaw is required for one cut to each track.

\*\*Based on average DIY skills and standard door application, widths 32"-36".

\*\*\*Retractable screen frame colors are complementary to PrismaGuard, but not an exact match.

Note: Recommended for inswing applications only. Therma-Tru retractable screens are designed to support natural ventilation and protection against airborne insects and other pests. Windy conditions may affect the performance of the screen. Retract the screen in windy circumstances, during inclement weather and when not needed to support immediate ventilation or prolonged periods of time when not used. Not intended to keep pets inside. See your Therma-Tru seller or visit [thermatru.com](http://thermatru.com) for details on limited warranties and exclusions.



### AVAILABLE SIZES

(Available for most inswing units.)

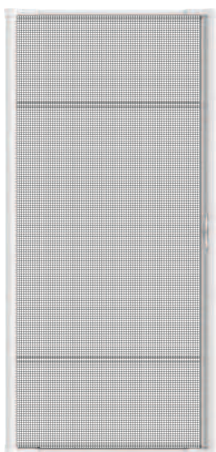

#### Single Door System

Widths: 32"-36"  
Heights: 6'6", 6'8", 8'0"

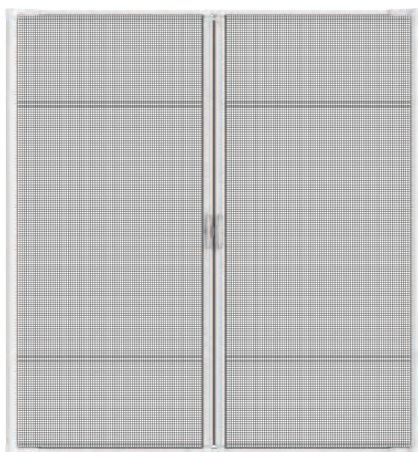

#### French Door System

Widths: 68"-73"  
Heights: 6'6", 6'8", 8'0"



Installation is quick and easy, taking approximately 30 minutes.\*\*

### AVAILABLE COLOR OPTIONS

Coordinates with exterior trim.\*\*



White



Brown



Black

### AVAILABLE CONFIGURATIONS

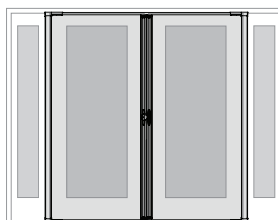
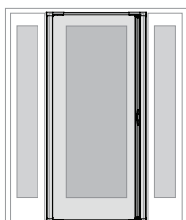
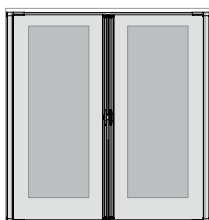

See your Therma-Tru seller for details on product availability and ordering.

### WARRANTY COVERAGE

All parts are covered by the Therma-Tru full-system limited warranty, excluding the screen mesh, when purchased and installed with a Therma-Tru door system.

When purchased and installed separately all parts are covered by a full-system lifetime limited warranty, excluding the screen mesh.



Classic Craft



Fiber-Classic,  
Smooth-Star,  
Pulse Fiberglass



Profiles, Traditions,  
Pulse Steel



# Impressions™ Integrated Storm & Entry Door System

The first of its kind, the Impressions storm and entry door system\* integrates the storm door flush into the brickmould portion of the door frame, creating a cohesive unit that provides a seamless look. With an integrated system engineered to work together, this system takes the guesswork out of ordering the right size storm door for your project and simplifies storm door installation.



- 1 Choose a **Therma-Tru. entry door** to create an entry that complements your home's architectural style.



- 2 The Impressions system comes standard with **composite brickmould** and an aluminum storm door panel. For added protection from rotting and to match the brickmould, choose a **composite frame featuring Tru-Guard™ composite technology.**



- 3 The storm door features a modern profile with mitered corners for a sleek, on-trend look that emphasizes the beauty of the entry door. The storm door panel fits into Therma-Tru's **flat-profile composite brickmould.**

\*Patent pending.

\*\*The Impressions system can be paired with a single sidelite on either side of the door or with two sidelites. Direct set sidelite options are also available.

\*\*\*Not suitable for use with Therma-Tru grip-style handlesets.

Note: See your Therma-Tru seller or visit [thermatru.com](http://thermatru.com) for details on limited warranties and exclusions.



**THE STORM DOOR IS EASY TO INSTALL AT THE JOBSITE**

The concealed hinges featuring retractable pins **4** and the revolutionary hidden closer with Click&Hold™ technology **5** enable a quick and intuitive installation experience. After the installation of the entry door, install the closer, sweep and hardware. Then, follow these three simple steps to complete the job.



**Scan the QR code to learn more about storm door panel installation.**

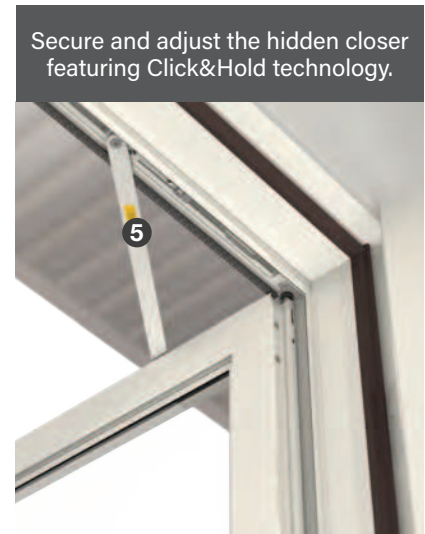
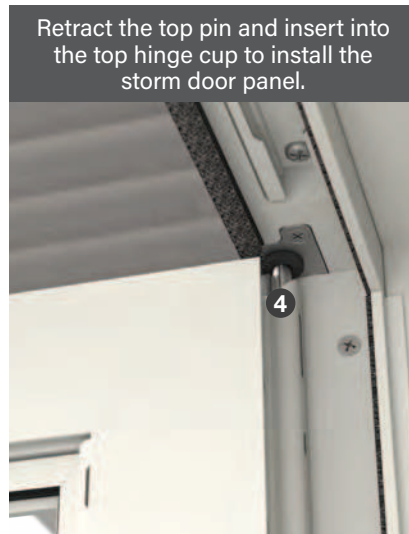
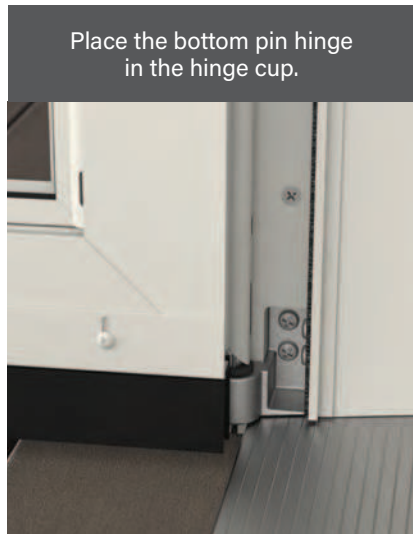

**6 ALUMINUM STORM DOOR OPTIONS**

**Available Sizes & Configurations**

Choose Low-E or clear glass.  
Interchangeable screen panel included.



**IM100**  
3'0" x 6'8"  
2'8" x 6'8"

**IM8100**  
3'0" x 8'0"  
2'8" x 8'0"



Single

Single with 1 Sidelite\*\*

Single with 2 Sidelites\*\*

**Color Options**

Features a maintenance-free finish.

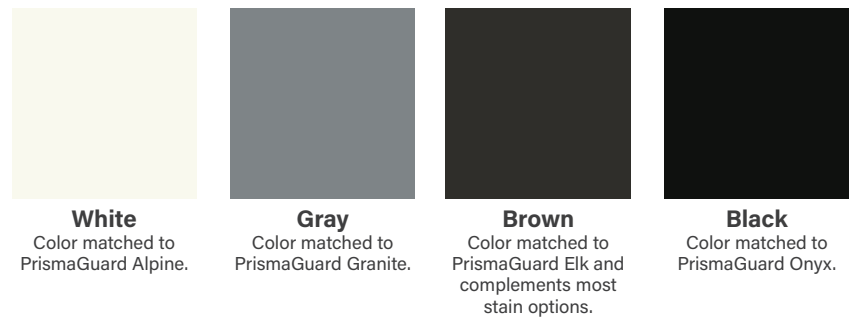

**7 QuickFit™ Handlesets\*\*\***

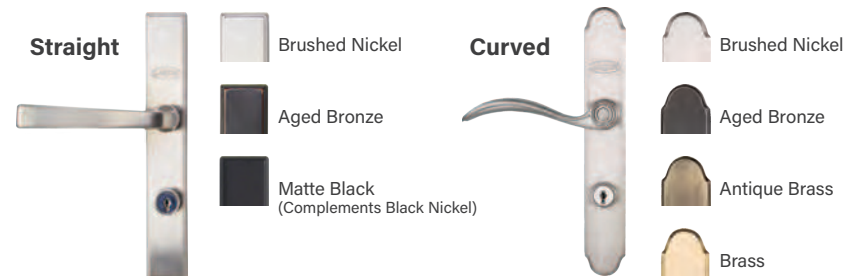

# Home, unbound.

The feeling of home extends beyond four walls as homeowners focus on connecting with nature. Blur the lines between indoor and outdoor living spaces with entry doors designed as beautiful connection points.



# Veris<sup>™</sup>

COLLECTION

Explore an expansive portfolio of glass-forward aluminum door systems from the entry door brand building professionals choose most.\* Redefine indoor and outdoor living with the Veris Collection.

# Open to possibilities.

The Veris™ Collection embodies a reconnection between home and outdoors. Sleek, minimalist designs perfectly frame the view. Expansive glass welcomes an abundance of natural light.

## THE VERIS COLLECTION



Folding Doors



Sliding Doors



Hinged Doors



Pivot Doors



These contemporary glass door systems bring together high-end style and unique functionality to create a bright and airy experience. Blending beauty and versatility, the Veris Collection offers a seamless transition from indoors to out.



Expand their horizon.

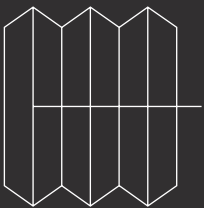

Blend indoor and outdoor living spaces with wide views, contemporary framing and innovative options designed for convenience and ease.

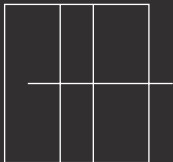

Contemporary connections.





Create statement-making entrances with sleek and subtle designs perfect for homes with contemporary styling.

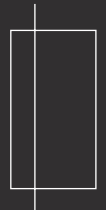



# Experience the Veris™ Collection.



Scan the QR code to view the complete Veris Collection catalog.

Print copies are available — contact your Therma-Tru<sup>®</sup> representative for ordering information.



Explore options and see it in your home with our visualizer at [veriscollection.com](https://www.veriscollection.com).

Veris<sup>™</sup>  
COLLECTION

# Classic Craft®



## An unrivaled entry experience.

Transform the entry into a one-of-a-kind experience. One that blends artistry, craftsmanship and modern engineering. Captivate the senses with remarkably authentic wood grains, exquisite handcrafted glass and sumptuous design details found only in Classic Craft. Because homes with uncompromising style demand uncompromising entryways.

Top: Classic Craft Mahogany Grain, Low-E Glass with SDLs, Doors - CCM82804, Finish - Driftwood  
Right Page Top: Classic Craft Fir Grain, Low-E Glass with SDLs, Door - CCA230, Sidelites - CCA210SL, Finish - Raven  
Right Page Middle: Classic Craft Mahogany Grain, Low-E Glass with SDLs, Doors - CCM8306CAL, CCM8306CAR, Finish - Acorn  
Right Page Bottom: Classic Craft Walnut Grain Door - CCW8906R, Low-E Direct Set Sidelite - DRS82131SL, Finish - Lynx

# Curated collections inspired by style.

Classic Craft celebrates the best of design for homes with uncompromising style. Three expertly curated collections draw inspiration from the latest trends and bring your home design vision to life with unrivaled beauty, luxe craftsmanship and an attention to detail you won't find anywhere else.

## Artissa Collection

CASUAL | RELAXED | SIMPLE



## Founders Collection

TRADITIONAL | TIME-HONORED | DECORATIVE



## Visionary Collection

MODERN | CONFIDENT | MINIMAL





## Comprehensive warranties for peace of mind.



Uniquely designed by Therma-Tru, Classic Craft® complete entryway systems are backed by an industry-leading 1x transferable lifetime limited warranty from the entry door brand building professionals choose most.\* This comprehensive lifetime limited warranty can be transferred one time to a new owner, should you ever sell your home.



In addition, Classic Craft entryways with our handcrafted and professionally applied PrismaGuard® premium stain or paint are backed by a transferable 10-year limited finish warranty – Therma-Tru's best. The balance of this finish warranty can transfer to a second owner.

Learn about our warranties at [thermatru.com/warranty](https://thermatru.com/warranty).

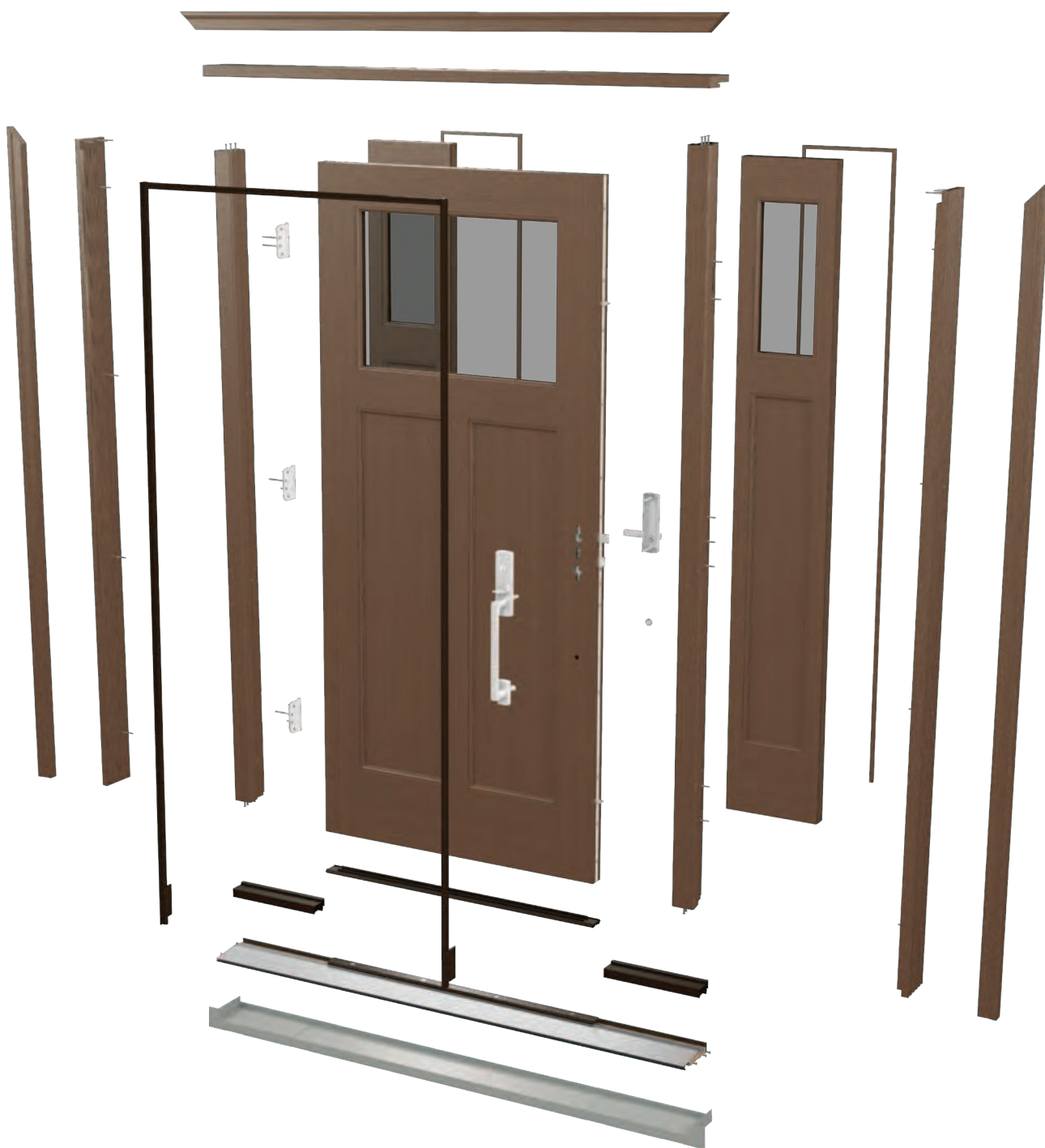

## Next-level engineering.

Classic Craft complete entryway systems are designed with a full suite of premium-grade components, including ball-bearing hinges, medium-reach weatherstrip, 7-shape corner seal pads and more. Each piece is engineered with craftsman precision to create an unrivaled entry experience built to perform for a lifetime.

\*Brand Use Study, 2023 *Builder* magazine.

Left Page: Classic Craft Mahogany Grain, Borrassa Glass, Door - CCM81519

# Premium construction, inside and out.

Highlighting the best of craftsmanship and innovation, Classic Craft® premium entryways boast impressive, well-designed features and remarkable construction. The inner workings of each Classic Craft door lay the foundation for exceptional strength, security, energy efficiency and long-term performance you can depend on for years to come.



## Engineered for Moisture Protection

Features composite top and bottom rails and solid hardwood edges for increased moisture and rot protection all the way around the door.



## Designed with Authenticity

Features construction identical to wood doors with narrow stiles and rails, and flush-glazed glass options that are more than 10% wider\* to welcome more natural light into the home.



## Tested to Withstand Mother Nature

Designed and rigorously tested to withstand and protect from the damaging effects of harsh weather conditions.

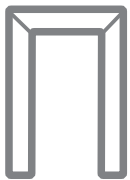

## Thermo-Tru. Door Frame

Created specifically for Thermo-Tru doors to deliver an entire entry system designed and engineered to work together to resist leaks and drafts, and help maintain energy efficiency and weather resistance.



\*Comparison of Classic Craft to other standard fiberglass doors with similar styles. Visit [thermatru.com](http://thermatru.com) for details.

\*\*Comparison of R-Values of fiberglass to wood doors (both without glass).

Right Page Top: Classic Craft Walnut Grain Door – CCW8901L; Low-E Glass Direct Set Sidelite – DRS82131SL, Finish – Acorn

Right Page Middle: Classic Craft Mahogany Grain, Homeward Glass, Door – CCM82801, Finish – Barley





### **Designed for Long-Term Performance**

Features fiberglass skins that are 46% thicker\* for added durability and better long-term performance.



### **Triple-Pane Construction**

Most decorative, privacy and textured glass panels are enclosed between tempered glass, offering superior quality and thermal performance.



### **Crafted for a True-to-Wood Appearance**

Revolutionary AccuGrain<sup>®</sup> technology replicates authentic natural wood textures for a look and feel that is virtually indistinguishable from real wood.



### **Built for Strength and Security**

Constructed with a 4" wide board of engineered lumber that runs the full length of the locking side of the door for a solid natural wood feel that makes Classic Craft doors 50% stronger and 30% heavier.\*



### **Constructed for Energy Efficiency**

Built with a high-performance polyurethane foam core that is four times more energy efficient than wood.\*\*



## True-to-Wood Origins

Revel in the handcrafted look and feel of a premium fiberglass entryway with true-to-wood origins. Discover exquisite textures with grains hand-selected from the finest natural wood species and meticulously recreated with our revolutionary AccuGrain® technology.

**AccuGrain.**  
TECHNOLOGY

Bottom: Classic Craft Walnut Grain, Door - CCW900L, Finish - Shale

### Fir Grain

Formerly Classic-Craft American Style

Designed to echo the grain of the largest species of American Hemlocks – the Western Hemlock tree – found in lush coastal rainforests of the Pacific Northwest.

### Walnut Grain

Crafted to reflect the prized hardwood of the mighty Black Walnut trees, these doors feature a horizontal grain with natural movement accented by delicate arches and cathedrals.



### Mahogany Grain

Formerly Classic-Craft Mahogany & Rustic

Derived from the finest African and Honduran Mahogany, blending rustic influences with exotic roots to build upon the rich history of one of the most renowned woods in the world.

### Canvas

Inspired by the world's most exquisite masterpieces and designed with the architectural character of finely sanded wood.



# Decorative & Specialty Glass Designs

## Homeward™

The balanced Mission-style pattern of Homeward invites light to cascade through its distinctive **1** clear bevels, **2** seeded glass and **3** gray antique glass. An ideal complement for a Transitional home design.

### GLASS SHAPES



### GLASS PRIVACY RATING

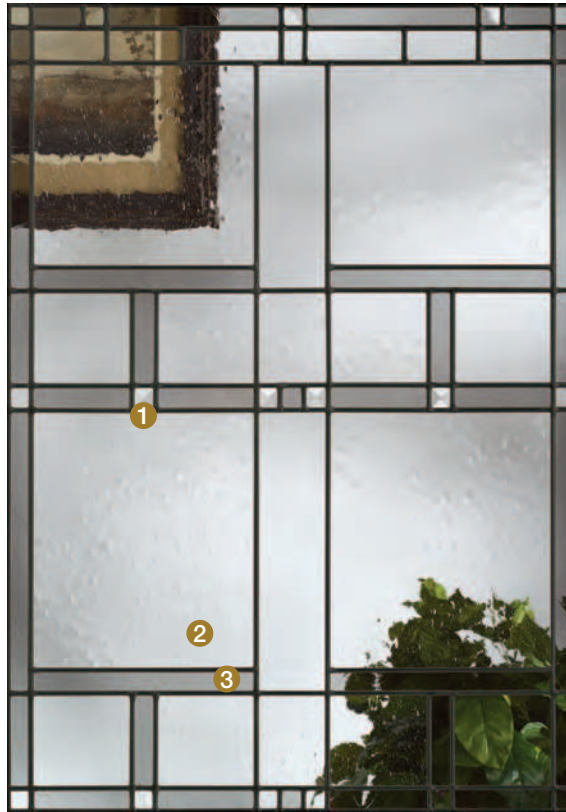

Black Nickel



Brushed Nickel

## Arborwatch®

An eclectic interpretation of the Arts and Crafts movement, Arborwatch combines **1** narrow reeded glass, **2** M seedy glass, **3** waterglass and coming in a symmetrical arrangement accented by **4** pale amber glass, **5** amber antique glass and **6** clear bevels.

### GLASS SHAPES



### GLASS PRIVACY RATING



Black Nickel



Brushed Nickel

Note: The use of pale amber and amber antique glass varies based on glass size. Refer to the image on page 60 to see an example on a home.

Note: Glass privacy ratings may be more or less than indicated, based on glass design and size of glass. Glass designs may differ from depiction due to size and hand craftsmanship of glass. See your Therma-Tru seller or visit [thermatru.com](http://thermatru.com) for details on glass privacy ratings and designs.

## Augustine®

Augustine's swirl leaf design adds that touch of elegance. Made of round wrought iron and 1 granite glass for the ultimate in privacy, Augustine pays homage to classic English styling.

### GLASS SHAPES



Corresponding sidelites feature Granite glass without wrought iron.

### GLASS PRIVACY RATING



Wrought Iron

Note: Features a lite frame with an authentic wrought iron look in a black finish. Refer to the image on page 77 to see an example on a home.

## Borrassa®

A statement of strength and beauty, Borrassa combines linear and curved wrought iron with 1 hammered glass for the ultimate in privacy. Wrought iron decorative accents add an authentic Old World feel to this stately design.

### GLASS SHAPES



Corresponding sidelites feature Hammered glass without wrought iron.

### GLASS PRIVACY RATING



Wrought Iron

Note: Features a lite frame with an authentic wrought iron look in a black finish. Refer to the image on page 46 to see an example on a home.

# Decorative & Specialty Glass Designs

## Provincial<sup>™</sup>

A unique diamond-based motif features **1** double waterglass, **2** clear bevels and coming surrounded by a **3** gray baroque glass border. Provincial captivates with stunning clarity.

### GLASS SHAPES



### GLASS PRIVACY RATING



Black Nickel



Brushed Nickel

## Longford<sup>™</sup>

The traditional design of Longford integrates a hint of a Celtic knot with **1** seeded glass, **2** clear bevels, **3** granite glass and coming. A timeless design ideal for entries where modest privacy is desired.

### GLASS SHAPES



### GLASS PRIVACY RATING

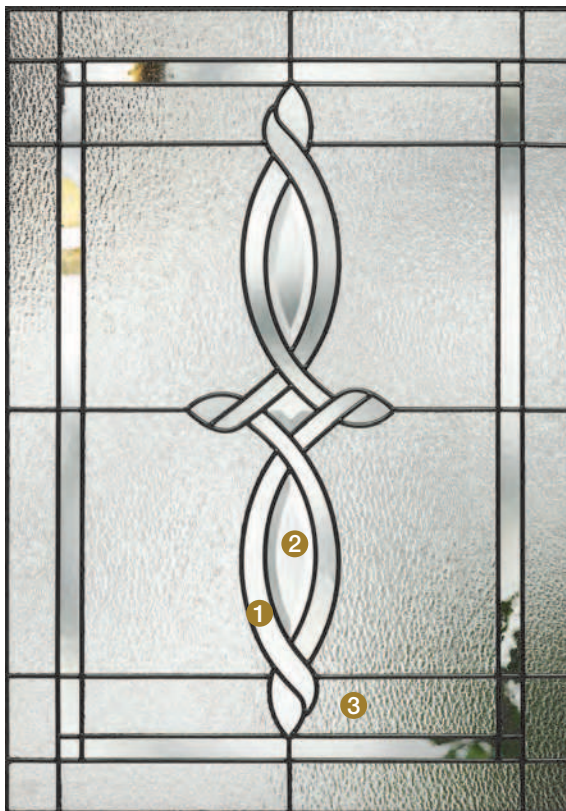

Black Nickel



Brushed Nickel

Note: Glass privacy ratings may be more or less than indicated, based on glass design and size of glass. Glass designs may differ from depiction due to size and hand craftsmanship of glass. See your Therma-Tru seller or visit [thermatru.com](http://thermatru.com) for details on glass privacy ratings and designs.

## Lucerna®

Named for the beauty of light it reflects, Lucerna glass presents an elegant, updated fleur-de-lis pattern in a spectrum of ① curved, ② diamond and ③ rectangular bevels surrounded by smooth, swirling ④ barn wood and heavily textured ⑤ diamond border glass.

### GLASS SHAPES



### GLASS PRIVACY RATING



Black Nickel



Brushed Nickel

## Zaha®

Structured right angles are offset by dynamic curves in this high-energy design. Zaha features ① oceana and ② seedy glass, ③ clear and ④ multifaceted bevels, and coming to create a refreshing and unexpected elegance that appeals to Contemporary home styles.

### GLASS SHAPES



### GLASS PRIVACY RATING



Black Nickel



Brushed Nickel

# Privacy & Textured Glass

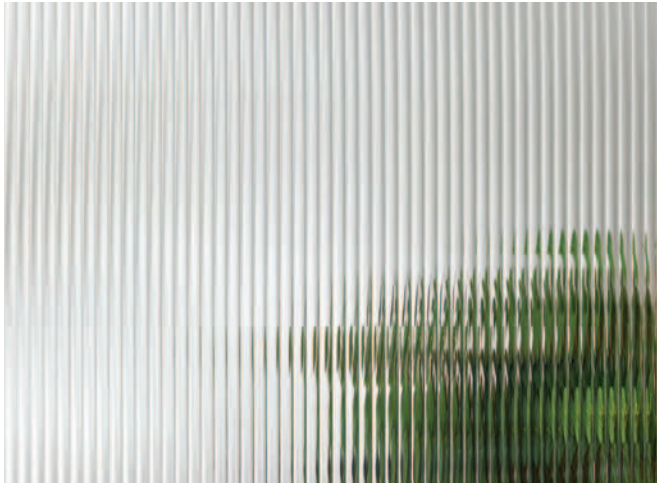

## Reeded (XK)

A vertical, linear textured glass that provides modest privacy and an on-trend aesthetic.

### GLASS PRIVACY RATING



## Satin Etch (XE)

A fine-textured pearlescent glass that delivers a pure, simple design aesthetic.

### GLASS PRIVACY RATING



## Chord (XC)

A vertical flowing pattern reminiscent of waves on the water.

### GLASS PRIVACY RATING



## Chinchilla (XJ)

A free-flowing configuration, presenting quiet lines and curves.

### GLASS PRIVACY RATING



Note: Glass privacy ratings may be more or less than indicated, based on glass design and size of glass. Glass designs may differ from depiction due to size and hand craftsmanship of glass. See your Therma-Tru seller or visit [thermatru.com](http://thermatru.com) for details on glass privacy ratings and designs.





## Rainglass (XR)

An elegantly fashioned glass, featuring ripples of cascading water.

### GLASS PRIVACY RATING



## Also Available: Low-E Glass



In cold weather, Low-E glass reflects the heat back inside to help keep your home warm.

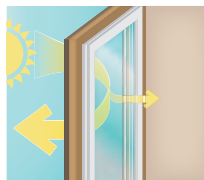

In warm weather, Low-E glass reflects the sun's rays off of the glass to help keep your home cool.



## Granite (XN)

A coarse-grained arrangement with surface detail over the entirety of the glass.

### GLASS PRIVACY RATING



# Divided Lites

Enhance the beauty of any home with divided lites for entry and patio doors. Increase curb appeal by coordinating with window grid patterns for a cohesive look that suits the home's architectural details.

## Simulated Divided Lites (SDLs)

Wood-grained or smooth SDL bars adhere to the interior and exterior panes of tempered glass and can be stained or painted to complement the door and home. Look for the (  ) icon.

4-¼" and 5-½" flat profile bars are also used on solid-panel doors as door divider bars (DDBs). Look for the (  ) icon.



(107.95 mm / 4.25 in.) Look for the (  ) and (  ) icons.

(139.70 mm / 5.5 in.) Look for the (  ) and (  ) icons.

Note: Some door styles use a combination of 4-¼" and 5-½" divider bars. Look for the (  ) and (  ) icons.



Fir Grain

Canvas





## Flush-Glazed Sticking Profiles

EnLiten™ flush-glazed designs feature a seamless look with simple profile around the glass.

Look for the ( 🔸 ) and ( 🔹 ) icons.

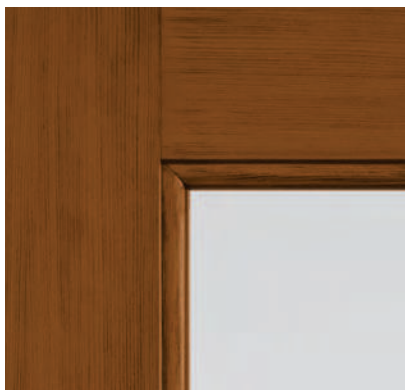

**Detailed Sticking**  
Look for the ( 🔸 ) icon.

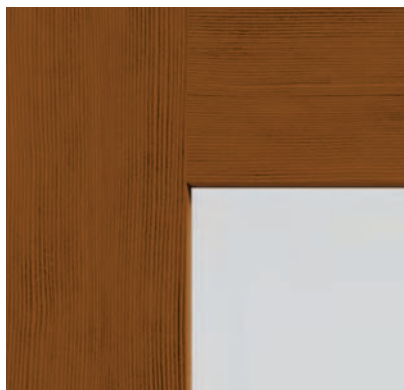

**Square Sticking**  
Look for the ( 🔹 ) icon.

### EnLiten™ Flush-Glazed Warranty Riders

for Construction & Installation,  
and Homeowners. See page 123  
for details.

Note: See your Therma-Tru seller or visit [thermatru.com](http://thermatru.com) for details on available product sizes and options, limited warranties and exclusions, and Riders.

Left Page: Classic Craft Canvas, Low-E Glass with SDLs, Door – CCV960, Sidelites – CCV9020SL, Transom – 19220T, Finish – Cypress  
Top: Classic Craft Fir Grain, Low-E Glass with SDLs, Doors – CCA82350, Finish – Raven

# Dentil Shelves

Complete the look with a dentil shelf for true Craftsman appeal or to complement other architectural elements around the house. Includes 4- and 16-block options.



**Classic Craft. Fir Grain 4-Block Dentil Shelf**



**Classic Craft. Fir Grain 4-Block Dentil Shelf\***



**Classic Craft. Fir Grain 16-Block Dentil Shelf**



**Classic Craft. Canvas 4-Block Dentil Shelf**



**4-Block Dentil Shelf**  
Shown on 3'6" x 8'0" door.



**4-Block Dentil Shelf**  
Shown on 3'0" x 8'0" door.

\*Pairs with 3'6" wide doors.

Bottom: Classic Craft Fir Grain, Arborwatch Glass, Door – CCA9100, Sidelites – CCA1423SL, Finish – Autumn Harvest; Dentil Shelf  
 Right Page, Left: Classic Craft Mahogany Grain Door – CCR205; Smooth-Star, Clear Glass with GBGs Sidelites – S1170SL, Clear Glass Transom – 19220T; Clavos  
 Right Page, Right: Classic Craft Mahogany Grain Door – CCR100R, Finish – Lynx; Strap Hinges



# Clavos & Strap Hinges

Add a finishing touch of rustic flavor with decorative hardware in an authentic, hand-forged wrought iron look with a black finish. Includes pyramid and round clavos, as well as strap hinges.



# Full Lites

## Mahogany Grain

Formerly Classic-Craft  
Mahogany & Rustic

Canvas

### Key

-  Flush-Glazed Glass with Square Sticking (FG)
-  Black Nickel Caming (1D)
-  Brushed Nickel Caming (1C)
-  Wrought Iron (1W)

## HOMEWARD™



**Mahogany**

CCR9925  
3'0" x 6'8"



**Mahogany**

CCR9925SL  
12" x 6'8"  
14" x 6'8"



**Canvas**

CCV9925  
3'0" x 6'8"



**Canvas**

CCV911SL  
12" x 6'8"  
14" x 6'8"

## ARBORWATCH®



**Mahogany**

CCR1423  
3'0" x 6'8"



**Mahogany**

CCR1423SL  
12" x 6'8"  
14" x 6'8"

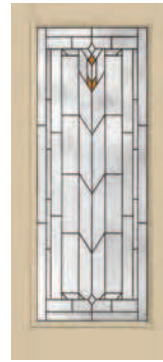

**Canvas**

CCV1423  
3'0" x 6'8"



**Canvas**

CCV1423SL  
12" x 6'8"  
14" x 6'8"

## AUGUSTINE. X



**Mahogany**

CCR30027  
3'0" x 6'8"



**Mahogany**

CCR3400XNSL  
12" x 6'8"  
14" x 6'8"



**Canvas**

CCV10027  
3'0" x 6'8"



**Canvas**

CCV100XNSL  
12" x 6'8"  
14" x 6'8"

For transoms, see page 102.

Note: Product images show exterior side of door.

**BORRASSA** ✕



**Mahogany**

CCR1528  
3'0" x 6'8"



**Mahogany**

CCR3400XHSL  
12" x 6'8"  
14" x 6'8"



**Canvas**

CCV1528  
3'0" x 6'8"



**Canvas**

CCV100XHSL  
12" x 6'8"  
14" x 6'8"

**PROVINCIAL** ™



**Mahogany**

CCR30028  
3'0" x 6'8"



**Mahogany**

CCR3408SL  
12" x 6'8"  
14" x 6'8"



**Canvas**

CCV10028  
3'0" x 6'8"



**Canvas**

CCV108SL  
12" x 6'8"  
14" x 6'8"

**LONGFORD** ™



**Mahogany**

CCR30023  
3'0" x 6'8"



**Mahogany**

CCR3407SL  
12" x 6'8"  
14" x 6'8"

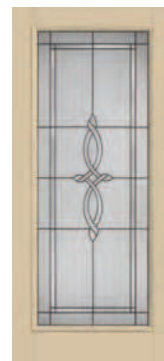

**Canvas**

CCV10023  
3'0" x 6'8"



**Canvas**

CCV103SL  
12" x 6'8"  
14" x 6'8"

**LUCERNA** ✕



**Mahogany**

CCR10022  
3'0" x 6'8"



**Mahogany**

CCR3412SL  
12" x 6'8"  
14" x 6'8"



**Canvas**

CCV10022  
3'0" x 6'8"



**Canvas**

CCV3412SL  
12" x 6'8"  
14" x 6'8"

# Full Lites

continued

## Fir Grain

Formerly Classic-Craft  
American Style

## Mahogany Grain

Formerly Classic-Craft  
Mahogany & Rustic

## Canvas

### Key

-  Flush-Glazed Glass with Square Sticking (FG)
-  Black Nickel Caming (1D)
-  Brushed Nickel Caming (1C)
-  Simulated Divided Lites (SDLF3)
-  Simulated Divided Lites (SDLF4)
-  Simulated Divided Lites (SDLF5)
-  Elevated 10" Bottom Rail Options

### Privacy & Textured Glass Options



Add the code to the blank in the style number for the desired door and glass combination. For details on glass options, see pages 56-57.

- XK = Reeded
- XJ = Chinchilla
- XE = Satin Etch
- XR = Rainglass
- XC = Chord
- XN = Granite

For transoms, see page 102.

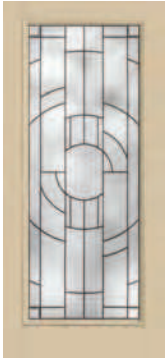
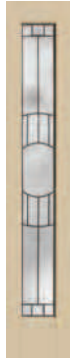

Note: Product images show exterior side of door.

**ZAHA**

			
<b>Mahogany</b>	<b>Mahogany</b>	<b>Canvas</b>	<b>Canvas</b>
CCR1851 3'0" x 6'8"	CCR1851SL 12" x 6'8" 14" x 6'8"	CCV1851 3'0" x 6'8"	CCV1851SL 12" x 6'8" 14" x 6'8"

**PRIVACY & TEXTURED**

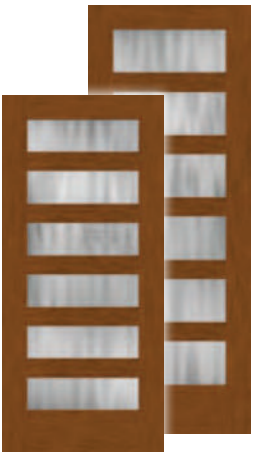
		
<b>Fir</b>	<b>Fir</b>	<b>Fir</b>
CCA2300 3'0" x 6'8"	CCA82300 3'0" x 8'0"	CCA2320 3'0" x 6'8"
	CCA2310 3'0" x 6'8"	CCA82310 3'0" x 8'0"
		CCA82320 3'0" x 8'0"

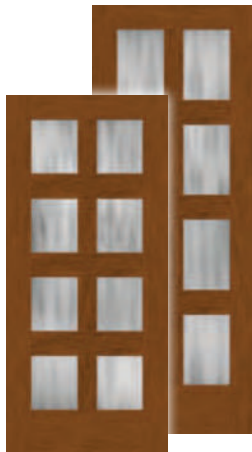
		
<b>Fir</b>	<b>Fir</b>	<b>Fir</b>
CCA2330 3'0" x 6'8"	CCA82330 3'0" x 8'0"	CCA2380 3'0" x 6'8"
	CCA2340 3'0" x 6'8"	CCA82380 3'0" x 8'0"
	CCA82340 3'0" x 8'0"	

\*Not available with Reeded (XK) glass.

Note: See page 285 for important product details that may help with your purchase decision.





Fir

CCA2350\_\*  
  
 3'0" x 6'8"

CCA82350\_\*  
  
 3'0" x 8'0"



Fir

CCA2360\_\*  
  
 3'0" x 6'8"

CCA82360\_\*  
  
 3'0" x 8'0"

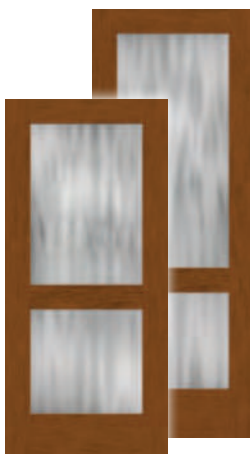

Fir

CCA2370\_\*  
  
 3'0" x 6'8"

CCA82370\_\*  
  
 3'0" x 8'0"



Fir

CCA4900\_\*  
  
 3'0" x 6'8"

CCA84900\_\*  
  
 3'0" x 8'0"

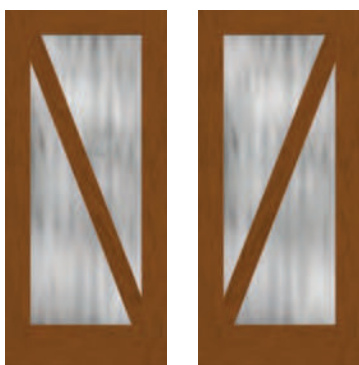

Fir

CCA4910L\_\*  
  
 3'0" x 6'8"

CCA4910R\_\*  
  
 3'0" x 6'8"

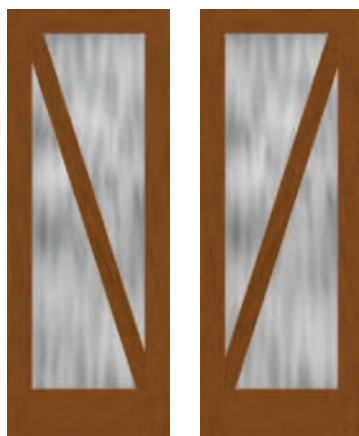

Fir

CCA84910L\_\*  
  
 3'0" x 8'0"

CCA84910R\_\*  
  
 3'0" x 8'0"

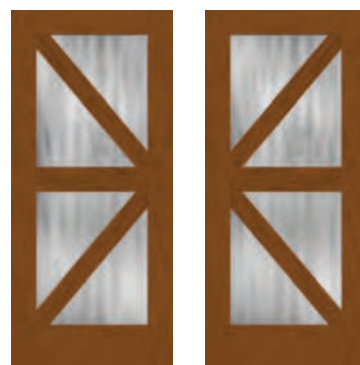

Fir

CCA4920L\_\*  
  
 3'0" x 6'8"

CCA4920R\_\*  
  
 3'0" x 6'8"

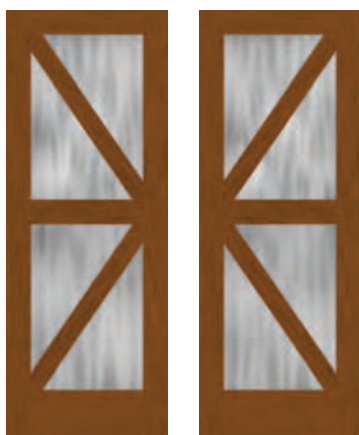

Fir

CCA84920L\_\*  
  
 3'0" x 8'0"

CCA84920R\_\*  
  
 3'0" x 8'0"



Fir

CCA4930\_\*  
  
 3'0" x 6'8"

CCA84930\_\*  
  
 3'0" x 8'0"



Fir

CCA4940\_\*  
  
 3'0" x 6'8"

CCA84940\_\*  
  
 3'0" x 8'0"

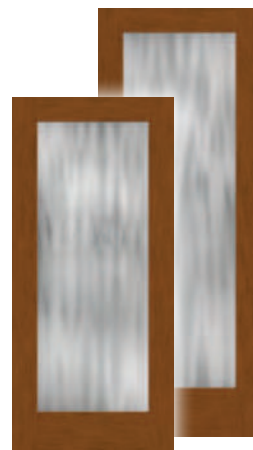

Fir

CCA2400\_\*  
  
 3'0" x 6'8"

CCA82400\_\*  
  
 3'0" x 8'0"







# Full Lites

continued

## Fir Grain

Formerly Classic-Craft  
American Style

### Key

-  Flush-Glazed Glass with Square Sticking (FG)
-  Low-E Glass (LE)
-  Simulated Divided Lites (SDLF3)
-  Simulated Divided Lites (SDLF4)
-  Simulated Divided Lites (SDLF5)
-  Elevated 10" Bottom Rail Options

### Privacy & Textured Glass Options





Add the code to the blank in the style number for the desired door and glass combination. For details on glass options, see pages 62–63.

- XK = Reeded
- XJ = Chinchilla
- XE = Satin Etch
- XR = Rainglass
- XC = Chord
- XN = Granite

## PRIVACY & TEXTURED







**Fir**

CCA2300__SL	CCA82300__SL
 	 
12" x 6'8"	12" x 8'0"
14" x 6'8"	14" x 8'0"







**Fir**

CCA2310__SL	CCA82310__SL
 	 
12" x 6'8"	12" x 8'0"
14" x 6'8"	14" x 8'0"







**Fir**

CCA2320__SL	CCA82320__SL
 	 
12" x 6'8"	12" x 8'0"
14" x 6'8"	14" x 8'0"







**Fir**

CCA2330__SL	CCA82330__SL
 	 
12" x 6'8"	12" x 8'0"
14" x 6'8"	14" x 8'0"







**Fir**

CCA2340__SL	CCA82340__SL
 	 
12" x 6'8"	12" x 8'0"
14" x 6'8"	14" x 8'0"







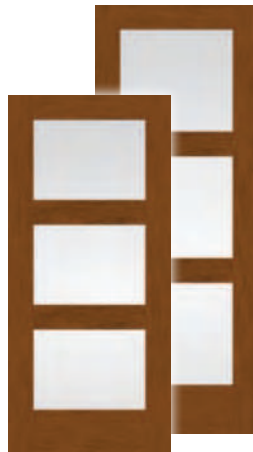

**Fir**

CCA2400__SL	CCA82400__SL
 	 
12" x 6'8"	12" x 8'0"
14" x 6'8"	14" x 8'0"

## LOW-E



**Fir**

CCA2300	CCA82300
  	   
3'0" x 6'8"	3'0" x 8'0"

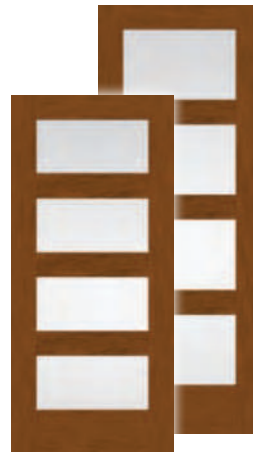







**Fir**

CCA2310	CCA82310
  	   
3'0" x 6'8"	3'0" x 8'0"



**Fir**

CCA2320	CCA82320
  	   
3'0" x 6'8"	3'0" x 8'0"

For transoms, see page 102.

Note: Product images show exterior side of door.



Fir

CCA2330  
  
 3'0" x 6'8"

CCA82330  
  
 3'0" x 8'0"

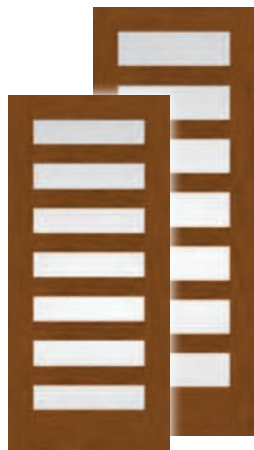

Fir

CCA2340  
  
 3'0" x 6'8"

CCA82340  
  
 3'0" x 8'0"

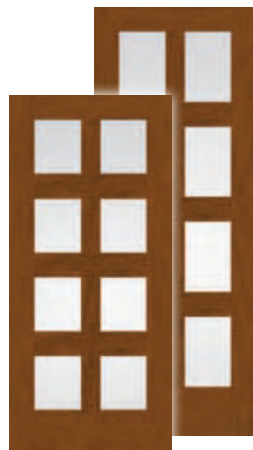

Fir

CCA2380  
  
 3'0" x 6'8"

CCA82380  
  
 3'0" x 8'0"



Fir

CCA2350  
  
 3'0" x 6'8"

CCA82350  
  
 3'0" x 8'0"



Fir

CCA2360  
  
 3'0" x 6'8"

CCA82360  
  
 3'0" x 8'0"



Fir

CCA2370  
  
 3'0" x 6'8"

CCA82370  
  
 3'0" x 8'0"



Fir

CCA4900  
  
 3'0" x 6'8"

CCA84900  
  
 3'0" x 8'0"

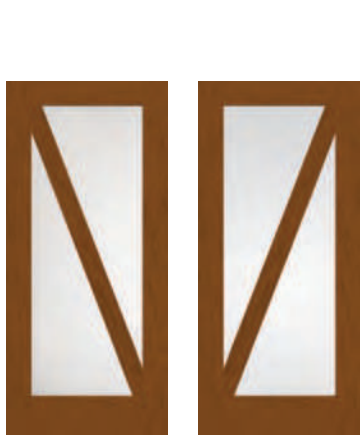

Fir

CCA4910L  
  
 3'0" x 6'8"

CCA4910R  
  
 3'0" x 6'8"

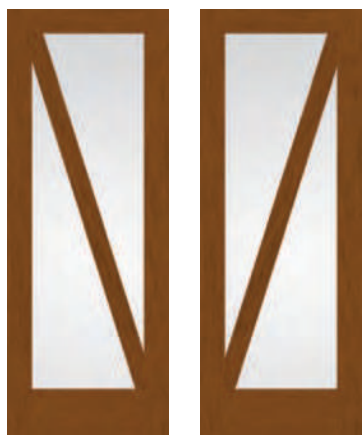

Fir

CCA84910L  
  
 3'0" x 8'0"

CCA84910R  
  
 3'0" x 8'0"



Fir

CCA4920L  
  
 3'0" x 6'8"

CCA4920R  
  
 3'0" x 6'8"

# Full Lites

continued

## Fir Grain





Formerly Classic-Craft  
American Style

## Mahogany Grain

Formerly Classic-Craft  
Mahogany & Rustic

## Canvas

### Key

-  Flush-Glazed Glass with Square Sticking (FG)
-  Low-E Glass (LE)
-  Simulated Divided Lites (SDL)
-  Simulated Divided Lites (SDLF3)
-  Simulated Divided Lites (SDLF4)
-  Simulated Divided Lites (SDLF5)
-  Simulated Divided Lites (SDLF6)
-  Elevated 10" Bottom Rail Options

For transoms, see page 102.

Note: Product images show exterior side of door.

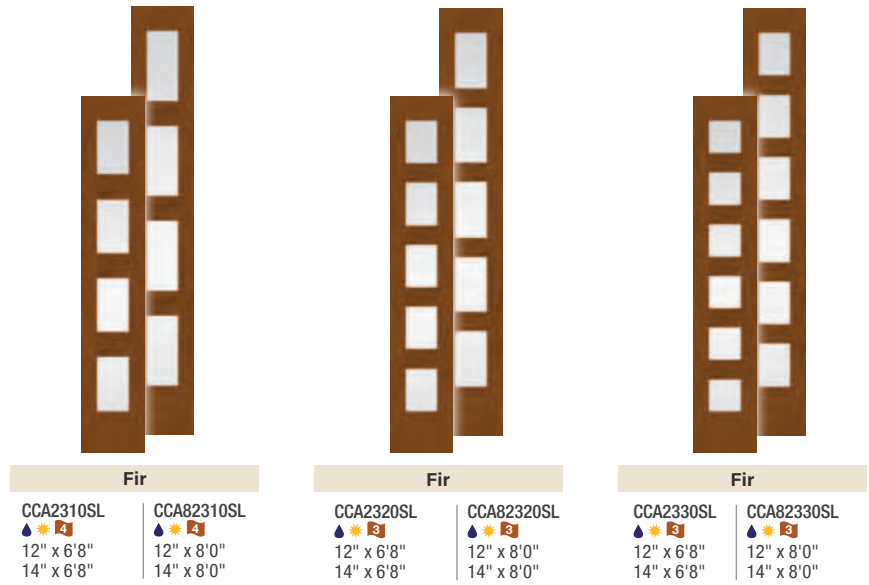
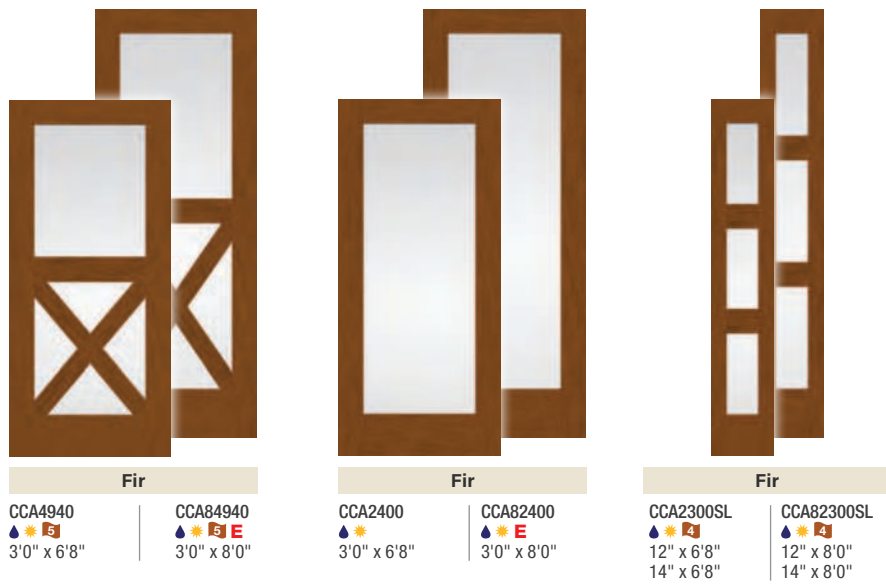
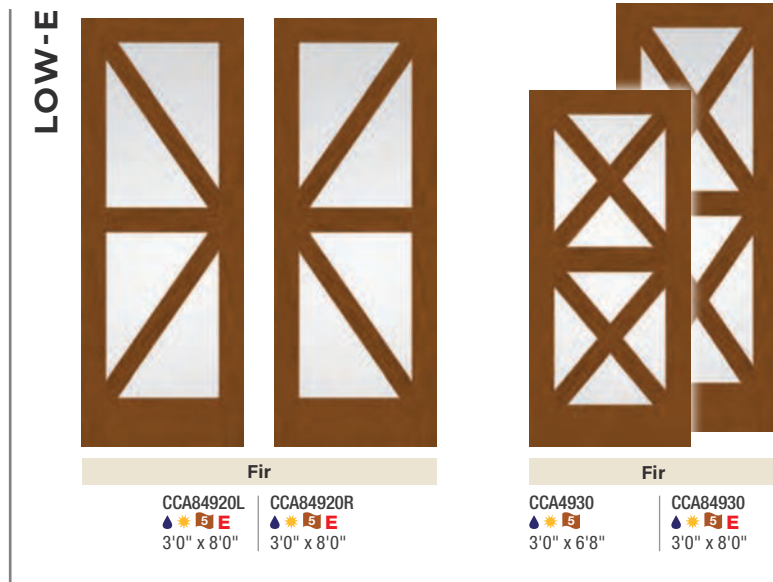

Note: See page 285 for important product details that may help with your purchase decision.

Right Page Top: Classic Craft Fir Grain, Low-E Glass with SDLs, Door – CCA2340, Sidelites – CCA2400SL, Finish – Rustic Clay  
Right Page Bottom: Classic Craft American Style Collection, Low-E Glass with SDLs, Doors – CCA4940



**Fir**

CCA2340SL  
 ▲ ★ R3  
 12" x 6'8"  
 14" x 6'8"

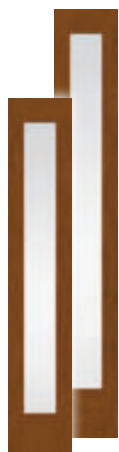

**Fir**

CCA82340SL  
 ▲ ★ R3  
 12" x 8'0"  
 14" x 8'0"

CCA2400SL  
 ▲ ★  
 12" x 6'8"  
 14" x 6'8"

CCA82400SL  
 ▲ ★  
 12" x 8'0"  
 14" x 8'0"



**Mahogany**

CCR30020  
 ★  
 3'0" x 6'8"



**Mahogany**

CCR2025SL  
 ▲ ★ R3  
 12" x 6'8"  
 14" x 6'8"



**Mahogany**

CCR3400SL  
 ▲ ★  
 12" x 6'8"  
 14" x 6'8"



**Canvas**

CCV10020  
 ★  
 3'0" x 6'8"



**Canvas**

CCV950SL  
 ▲ ★ R3  
 12" x 6'8"  
 14" x 6'8"



**Canvas**

CCV100SL  
 ▲ ★  
 12" x 6'8"  
 14" x 6'8"



# 3/4 Lites

## Mahogany Grain

Formerly Classic-Craft  
Mahogany & Rustic

Canvas



### Key

-  Flush-Glazed Glass with Square Sticking (FG)
-  Black Nickel Caming (1D)
-  Brushed Nickel Caming (1C)
-  Wrought Iron (1W)

HOMEWARD™



Mahogany

CCM2801 | CCM82801  
 3'0" x 6'8" |  3'0" x 8'0"







Mahogany

CCM9923  
 3'0" x 6'8"



Mahogany

CCR9925SL | CCR89925SL  
 12" x 6'8" |  12" x 8'0"  
 14" x 6'8" |  14" x 8'0"





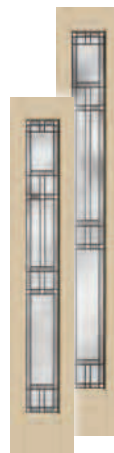

Canvas

CCV9922 | CCV89922  
 3'0" x 6'8" | 3'0" x 8'0"



Canvas

CCV911SL | CCV8111SL  
 12" x 6'8" |  12" x 8'0"  
 14" x 6'8" |  14" x 8'0"

ARBORWATCH®



Mahogany

CCM81418  
 3'0" x 8'0"







Mahogany

CCM1419  
 3'0" x 6'8"



Mahogany

CCR1423SL | CCR81423SL  
 12" x 6'8" |  12" x 8'0"  
 14" x 6'8" |  14" x 8'0"







Canvas

CCV1418 | CCV81418  
 3'0" x 6'8" | 3'0" x 8'0"



Canvas

CCV1423SL | CCV81423SL  
 12" x 6'8" |  12" x 8'0"  
 14" x 6'8" |  14" x 8'0"

For transoms, see page 102.

Note: Product images show exterior side of door.

**AUGUSTINE. X**



**Mahogany**

CCM805027  
3'0" x 8'0"



**Mahogany**

CCM1485  
3'0" x 6'8"



**Mahogany**

CCM1495  
3'0" x 6'8"



**Mahogany**

CCR3400XNSL	CCR8000XNSL
▲ 12" x 6'8"	▲ 12" x 8'0"
▲ 14" x 6'8"	▲ 14" x 8'0"



**Canvas**

CCV05027	CCV805027
3'0" x 6'8"	3'0" x 8'0"



**Canvas**

CCV100XNSL	CCV8100XNSL
▲ 12" x 6'8"	▲ 12" x 8'0"
▲ 14" x 6'8"	▲ 14" x 8'0"

**BORRASSA. X**



**Mahogany**

CCM81519  
3'0" x 8'0"



**Mahogany**

CCM1475  
3'0" x 6'8"



**Mahogany**

CCM1465  
3'0" x 6'8"



**Mahogany**

CCR3400XHSL	CCR8000XHSL
▲ 12" x 6'8"	▲ 12" x 8'0"
▲ 14" x 6'8"	▲ 14" x 8'0"



**Canvas**

CCV1519	CCV81519
3'0" x 6'8"	3'0" x 8'0"



**Canvas**

CCV100XHSL	CCV8100XHSL
▲ 12" x 6'8"	▲ 12" x 8'0"
▲ 14" x 6'8"	▲ 14" x 8'0"

**LONGFORD™**



**Mahogany**

CCM892  
3'0" x 8'0"



**Mahogany**

CCM203  
3'0" x 6'8"



**Mahogany**

CCM303  
3'0" x 6'8"

# 3/4 Lites

continued



**Mahogany Grain**  
Formerly Classic-Craft  
Mahogany & Rustic

Canvas

## Key









-  Flush-Glazed Glass with Detailed Sticking (FG)
-  Flush-Glazed Glass with Square Sticking (FG)
-  Black Nickel Caming (1D)
-  Brushed Nickel Caming (1C)
-  Simulated Divided Lites (SDLF6)

## Privacy & Textured Glass Options









Add the code to the blank in the style number for the desired door and glass combination. For details on glass options, see pages 62-63.











- XK = Reeded
- XJ = Chinchilla
- XE = Satin Etch
- XR = Rainglass
- XC = Chord
- XN = Granite

## LONGFORD™

			
<b>Mahogany</b>	<b>Mahogany</b>	<b>Canvas</b>	<b>Canvas</b>
CCM3303SL	CCR3407SL   CCR8007SL	CCV05023   CCV805023	CCV103SL   CCV8103SL
 12" x 6'8" 14" x 6'8"	 12" x 6'8" 14" x 6'8"	 12" x 8'0" 14" x 8'0"	 12" x 6'8" 14" x 6'8"

## LUCERNA®

		
<b>Mahogany</b>	<b>Mahogany</b>	<b>Mahogany</b>
CCM2802   CCM82802	CCR3412SL   CCR8102SL	CCM204
 3'0" x 6'8"    3'0" x 8'0"	 12" x 6'8" 14" x 6'8"    12" x 8'0" 14" x 8'0"	 3'0" x 6'8"

			
<b>Mahogany</b>	<b>Mahogany</b>	<b>Canvas</b>	<b>Canvas</b>
CCM302	CCM3302SL	CCV05022   CCV805022	CCV3412SL   CCV8102SL
 3'0" x 6'8"	 12" x 6'8" 14" x 6'8"	 3'0" x 6'8"    3'0" x 8'0"	 12" x 6'8" 14" x 6'8"    12" x 8'0" 14" x 8'0"

For transoms, see page 102.

Note: Product images show exterior side of door.

\*Not available with Chinchilla (XJ) glass.

Note: See page 285 for important product details that may help with your purchase decision.



PROVINCIAL™



Mahogany

CCR3408SL	CCR8008SL
12" x 6'8"	12" x 8'0"
14" x 6'8"	14" x 8'0"



Canvas

CCV05028	CCV805028
3'0" x 6'8"	3'0" x 8'0"

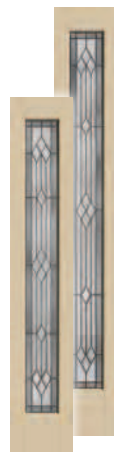

Canvas

CCV108SL	CCV8108SL
12" x 6'8"	12" x 8'0"
14" x 6'8"	14" x 8'0"

ZAHA™



Mahogany

CCM2803	CCM82803
3'0" x 6'8"	3'0" x 8'0"



Mahogany

CCR1851SL	CCR81851SL
12" x 6'8"	12" x 8'0"
14" x 6'8"	14" x 8'0"



Mahogany

CCM1844
3'0" x 6'8"



Mahogany

CCM1842
3'0" x 6'8"



Mahogany

CCM1843SL
12" x 6'8"
14" x 6'8"



Canvas

CCV1843	CCV81843
3'0" x 6'8"	3'0" x 8'0"

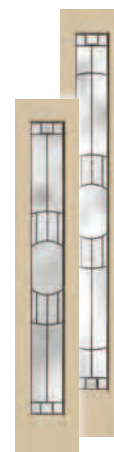

Canvas

CCV1851SL	CCV81851SL
12" x 6'8"	12" x 8'0"
14" x 6'8"	14" x 8'0"

PRIVACY & TEXTURED



Mahogany

CCM2804_*	CCM82804_*
3'0" x 6'8"	3'0" x 8'0"



Mahogany

CCM2806_*	CCM82806_*
3'0" x 6'8"	3'0" x 8'0"



Mahogany

CCM2812_*	CCM82815_*
3'0" x 6'8"	3'0" x 8'0"



Mahogany

CCM2800_*	CCM82800_*
3'0" x 6'8"	3'0" x 8'0"

# 3/4 Lites

continued



**Mahogany Grain**  
Formerly Classic-Craft  
Mahogany & Rustic

Canvas

## Key

-  Flush-Glazed Glass with Detailed Sticking (FG)
-  Flush-Glazed Glass with Square Sticking (FG)
-  Low-E Glass (LE)
-  Simulated Divided Lites (SDL)
-  Simulated Divided Lites (SDLF6)

## Privacy & Textured Glass Options

Add the code to the blank in the style number for the desired door and glass combination. For details on glass options, see pages 62-63.

**XE = Satin Etch**      **XR = Rainglass**  
**XC = Chord**          **XN = Granite**  
**XJ = Chinchilla**

For transoms, see page 102.

Note: Product images show exterior side of door.

## PRIVACY & TEXTURED



**Mahogany**

CCM200XC  
CCM200XN  
3'0" x 6'8"







**Mahogany**

CCM300XC  
CCM300XN  
3'0" x 6'8"





**Mahogany**

CCR2025_SL  	CCR82035_SL  
12" x 6'8"	12" x 8'0"
14" x 6'8"	14" x 8'0"



**Mahogany**

CCR3400_SL 	CCR8000_SL 
12" x 6'8"	12" x 8'0"
14" x 6'8"	14" x 8'0"







**Canvas**

CCV05020XC  
CCV05020XN  
3'0" x 6'8"





**Canvas**

CCV950_SL  	CCV8950_SL*  
12" x 6'8"	12" x 8'0"
14" x 6'8"	14" x 8'0"



**Canvas**

CCV100_SL 	CCV8100_SL* 
12" x 6'8"	12" x 8'0"
14" x 6'8"	14" x 8'0"

## LOW-E



**Mahogany**

CCM2804   	CCM82804   
3'0" x 6'8"	3'0" x 8'0"



**Mahogany**

CCM2806   	CCM82806   
3'0" x 6'8"	3'0" x 8'0"

\*Not available with Satin Etch (XE) glass.

Note: See page 285 for important product details that may help with your purchase decision.

Right Page: Classic Craft Mahogany Grain, Low-E Glass with SDLs, Door - CCM2806, Finish - Acorn



**Mahogany**

CCM2812 | CCM82815  
 ▲ 🔥 Ⓜ️ | ▲ 🔥 Ⓜ️  
 3'0" x 6'8" | 3'0" x 8'0"



**Mahogany**

CCM2800 | CCM82800  
 ▲ 🔥 | ▲ 🔥  
 3'0" x 6'8" | 3'0" x 8'0"



**Mahogany**

CCR2025SL | CCR82035SL  
 ▲ 🔥 Ⓜ️ | ▲ 🔥 Ⓜ️  
 12" x 6'8" | 12" x 8'0"  
 14" x 6'8" | 14" x 8'0"



**Mahogany**

CCR3400SL | CCR8000SL  
 ▲ 🔥 | ▲ 🔥  
 12" x 6'8" | 12" x 8'0"  
 14" x 6'8" | 14" x 8'0"



**Mahogany**

CCM200  
 🔥  
 3'0" x 6'8"



**Mahogany**

CCM300  
 🔥  
 3'0" x 6'8"



**Mahogany**

CCM3300SL  
 🔥 🔥  
 10" x 6'8"  
 12" x 6'8"  
 14" x 6'8"



**Canvas**

CCV05020 | CCV805020  
 🔥 | 🔥  
 3'0" x 6'8" | 3'0" x 8'0"



**Canvas**

CCV950SL | CCV8950SL  
 ▲ 🔥 Ⓜ️ | ▲ 🔥 Ⓜ️  
 12" x 6'8" | 12" x 8'0"  
 14" x 6'8" | 14" x 8'0"



**Canvas**

CCV100SL | CCV8100SL  
 ▲ 🔥 | ▲ 🔥  
 12" x 6'8" | 12" x 8'0"  
 14" x 6'8" | 14" x 8'0"



**Mahogany Grain**

Formerly Classic-Craft  
Mahogany & Rustic



Canvas

**Key**

- ◆ Black Nickel Caming (1D)
- ▣ Brushed Nickel Caming (1C)
- ✕ Wrought Iron (1W)

**Optional Accessories**



Clavos



Strap Hinge

For transoms, see page 102.

Note: Product images show exterior side of door.

**HOMEWARD™**



**Mahogany**

CCR9921  
3'0" x 6'8" | CCR89921  
3'0" x 8'0"  
3'6" x 8'0"



**Mahogany**

CCR9919  
3'0" x 6'8" | CCR89919  
3'0" x 8'0"  
3'6" x 8'0"



**Mahogany**

CCR9918  
3'0" x 6'8" | CCR89918  
3'0" x 8'0"



**Mahogany**

CCR822218  
3'0" x 8'0"  
3'6" x 8'0"



**Canvas**

CCV9919  
3'0" x 6'8" | CCV89919  
3'0" x 8'0"



**Canvas**

CCV9918  
3'0" x 6'8" | CCV89918  
3'0" x 8'0"

**ARBORWATCH®**



**Mahogany**

CCR1417  
3'0" x 6'8" | CCR81417  
3'0" x 8'0"  
3'6" x 8'0"



**Mahogany**

CCR1415  
3'0" x 6'8" | CCR81415  
3'0" x 8'0"  
3'6" x 8'0"



**Mahogany**

CCR1414  
3'0" x 6'8" | CCR81414  
3'0" x 8'0"

Note: See page 285 for important product details that may help with your purchase decision.

Right Page: Classic Craft Mahogany Grain, Augustine Glass, Door – CCR20527, Finish – New Earth



**Mahogany**

CCR822214  
3'0" x 8'0"  
3'6" x 8'0"

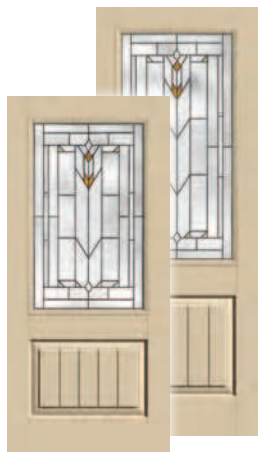

**Canvas**

CCV1415 | CCV81415  
3'0" x 6'8" | 3'0" x 8'0"

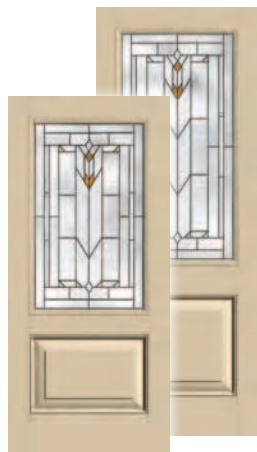

**Canvas**

CCV1414 | CCV81414  
3'0" x 6'8" | 3'0" x 8'0"

**AUGUSTINE®**



**Mahogany**

CCR04027 | CCR804027  
3'0" x 6'8" | 3'0" x 8'0"  
3'6" x 8'0"



**Mahogany**

CCR20527 | CCR820527  
3'0" x 6'8" | 3'0" x 8'0"  
3'6" x 8'0"



**Mahogany**

CCR20027 | CCR820027  
3'0" x 6'8" | 3'0" x 8'0"



**Mahogany**

CCR822227  
3'0" x 8'0"  
3'6" x 8'0"



**Mahogany**

CCR04037 | CCR804037  
3'0" x 6'8" | 3'0" x 8'0"  
3'6" x 8'0"

**AUGUSTINE** *Continues on next page.*



# 2/3 Lites

continued

## Mahogany Grain

Formerly Classic-Craft  
Mahogany & Rustic

Canvas

### Key

- ◆ Black Nickel Caming (1D)
- Brushed Nickel Caming (1C)
- ✕ Wrought Iron (W)

### Optional Accessories



Clavos



Strap Hinge

## AUGUSTINE ✕



Mahogany

CCR20537 | CCR820537  
3'0" x 6'8" | 3'0" x 8'0"  
3'6" x 8'0"



Mahogany

CCR20037 | CCR820037  
3'0" x 6'8" | 3'0" x 8'0"



Mahogany

CCR20537A | CCR820537A  
3'0" x 6'8" | 3'0" x 8'0"  
3'6" x 8'0"



Mahogany

CCR20037A | CCR820037A  
3'0" x 6'8" | 3'0" x 8'0"



Canvas

CCV20527 | CCV820527  
3'0" x 6'8" | 3'0" x 8'0"



Canvas

CCV22027 | CCV822027  
3'0" x 6'8" | 3'0" x 8'0"



Canvas

CCV20537 | CCV820537  
3'0" x 6'8" | 3'0" x 8'0"

## BORRASSA ✕



Mahogany

CCR1518 | CCR81518  
3'0" x 6'8" | 3'0" x 8'0"  
3'6" x 8'0"



Mahogany

CCR1516 | CCR81516  
3'0" x 6'8" | 3'0" x 8'0"  
3'6" x 8'0"

For transoms, see page 102.

Note: Product images show exterior side of door.



**Mahogany**

CCR1515 | CCR81515  
3'0" x 6'8" | 3'0" x 8'0"



**Mahogany**

CCR822215  
3'0" x 8'0"  
3'6" x 8'0"



**Mahogany**

CCR1514 | CCR81514  
3'0" x 6'8" | 3'0" x 8'0"  
3'6" x 8'0"



**Mahogany**

CCR1512 | CCR81512  
3'0" x 6'8" | 3'0" x 8'0"  
3'6" x 8'0"



**Mahogany**

CCR1511 | CCR81511  
3'0" x 6'8" | 3'0" x 8'0"



**Mahogany**

CCR1512A | CCR81512A  
3'0" x 6'8" | 3'0" x 8'0"  
3'6" x 8'0"



**Mahogany**

CCR1511A | CCR81511A  
3'0" x 6'8" | 3'0" x 8'0"



**Canvas**

CCV1516 | CCV81516  
3'0" x 6'8" | 3'0" x 8'0"



**Canvas**

CCV1515 | CCV81515  
3'0" x 6'8" | 3'0" x 8'0"



**Canvas**

CCV1512 | CCV81512  
3'0" x 6'8" | 3'0" x 8'0"

**PROVINCIAL™**



**Mahogany**

CCR804028  
3'0" x 8'0"



**Mahogany**

CCR820528  
3'0" x 8'0"

# 2/3 Lites

continued



**Mahogany Grain**  
Formerly Classic-Craft  
Mahogany & Rustic

Canvas

### Key

- ◆ Black Nickel Caming (1D)
- ▣ Brushed Nickel Caming (1C)

### Optional Accessories



Clavos



Strap Hinge

## PROVINCIAL™



**Mahogany**

CCR820028  
3'0" x 8'0"



**Mahogany**

CCR822228  
3'0" x 8'0"



**Canvas**

CCV820528  
3'0" x 8'0"



**Canvas**

CCV822028  
3'0" x 8'0"

## LONGFORD™



**Mahogany**

CCR04023 | CCR804023  
3'0" x 6'8" | 3'0" x 8'0"



**Mahogany**

CCR20523 | CCR820523  
3'0" x 6'8" | 3'0" x 8'0"



**Mahogany**

CCR20023 | CCR820023  
3'0" x 6'8" | 3'0" x 8'0"



**Mahogany**

CCR822223  
3'0" x 8'0"



**Canvas**

CCV20523 | CCV820523  
3'0" x 6'8" | 3'0" x 8'0"



**Canvas**

CCV22023 | CCV822023  
3'0" x 6'8" | 3'0" x 8'0"

For transoms, see page 102.

Note: Product images show exterior side of door.





**Mahogany**

CCR04022 | CCR804022  
3'0" x 6'8" | 3'0" x 8'0"  
3'6" x 8'0"



**Mahogany**

CCR20522 | CCR820522  
3'0" x 6'8" | 3'0" x 8'0"  
3'6" x 8'0"



**Mahogany**

CCR20022 | CCR820022  
3'0" x 6'8" | 3'0" x 8'0"



**Mahogany**

CCR822222  
3'0" x 8'0"  
3'6" x 8'0"



**Mahogany**

CCR804032  
3'0" x 8'0"



**Mahogany**

CCR820532  
3'0" x 8'0"



**Mahogany**

CCR820032  
3'0" x 8'0"



**Mahogany**

CCR820532A  
3'0" x 8'0"



**Mahogany**

CCR820032A  
3'0" x 8'0"



**Canvas**

CCV20522 | CCR820522  
3'0" x 6'8" | 3'0" x 8'0"



**Canvas**

CCV22022 | CCR822022  
3'0" x 6'8" | 3'0" x 8'0"



**Canvas**

CCV820532  
3'0" x 8'0"



**Mahogany**

CCR1841 | CCR81841  
3'0" x 6'8" | 3'0" x 8'0"

continued



## Mahogany Grain

Formerly Classic-Craft  
Mahogany & Rustic

Canvas

### Key

-  Flush-Glazed Glass with Square Sticking (FG)
-  Black Nickel Caming (1D)
-  Brushed Nickel Caming (1C)

### Privacy & Textured Glass Options

Add the code to the blank in the style number for the desired door and glass combination. For details on glass options, see pages 62-63.

- XE = Satin Etch      XR = Rainglass
- XG = Chord          XN = Granite

### Optional Accessories



Clavos



Strap Hinge

For transoms, see page 102.

Note: Product images show exterior side of door.

ZAHA®



Mahogany

CCR1839 | CCR81839  
3'0" x 6'8" | 3'0" x 8'0"



Mahogany

CCR1838 | CCR81838  
3'0" x 6'8" | 3'0" x 8'0"



Mahogany

CCR822238  
3'0" x 8'0"



Mahogany

CCR81847  
3'0" x 8'0"



Mahogany

CCR81846  
3'0" x 8'0"



Mahogany

CCR81845  
3'0" x 8'0"



Mahogany

CCR81846A  
3'0" x 8'0"



Mahogany

CCR81845A  
3'0" x 8'0"



Canvas

CCV1839 | CCV81839  
3'0" x 6'8" | 3'0" x 8'0"



Canvas

CCV1838 | CCV81838  
3'0" x 6'8" | 3'0" x 8'0"



Canvas

CCV81846  
3'0" x 8'0"

\*Not available with Satin Etch (XE) or Rainglass (XR) glass.

Note: See page 285 for important product details that may help with your purchase decision.

**PRIVACY & TEXTURED**



**Mahogany**

CCR04020\_\* | CCR804020\_\*  
3'0" x 6'8" | 3'0" x 8'0"



**Mahogany**

CCR20520\_\* | CCR820520\_\*  
3'0" x 6'8" | 3'0" x 8'0"



**Mahogany**

CCR20020\_\* | CCR820020\_\*  
3'0" x 6'8" | 3'0" x 8'0"



**Mahogany**

CCR822220\_\*  
3'0" x 8'0"



**Mahogany**

CCR804030\_\*  
3'0" x 8'0"



**Mahogany**

CCR820530\_\*  
3'0" x 8'0"



**Mahogany**

CCR820030\_\*  
3'0" x 8'0"



**Mahogany**

CCR820530A\_\*  
3'0" x 8'0"



**Canvas**

CCV20520\_\* | CCV820520\_\*  
3'0" x 6'8" | 3'0" x 8'0"



**Canvas**

CCV22020\_\* | CCV822020\_\*  
3'0" x 6'8" | 3'0" x 8'0"



**Canvas**

CCV820530\_\*  
3'0" x 8'0"



**Mahogany**

CCM302L\_\* | CCM302R\_\*  
3'0" x 6'8" | 3'0" x 6'8"



**Mahogany**

CCM8302L\_\* | CCM8302R\_\*  
3'0" x 8'0" | 3'0" x 8'0"

continued



**Mahogany Grain**  
Formerly Classic-Craft  
Mahogany & Rustic

### Key

-  Flush-Glazed Glass with Square Sticking (FG)
-  Low-E Glass (LE)
-  Simulated Divided Lites (SDLF6)

### Privacy & Textured Glass Options



Add the code to the blank in the style number for the desired door and glass combination. For details on glass options, see pages 62-63.

- XE = Satin Etch
- XR = Rainglass
- XC = Chord
- XN = Granite

## PRIVACY & TEXTURED



Mahogany

CCM304L__	CCM304R__
 	 
3'0" x 6'8"	3'0" x 6'8"



Mahogany

CCM8304L__	CCM8304R__
 	 
3'0" x 8'0"	3'0" x 8'0"



Mahogany

CCM303L__	CCM303R__
 	 
3'0" x 6'8"	3'0" x 6'8"



Mahogany

CCM8303L__	CCM8303R__
 	 
3'0" x 8'0"	3'0" x 8'0"



Mahogany

CCM301CAL__	CCM301CAR__
	
3'0" x 6'8"	3'0" x 6'8"



Mahogany

CCM8301CAL__	CCM8301CAR__
	
3'0" x 8'0"	3'0" x 8'0"

For transoms, see page 102.

Note: Product images show exterior side of door.



Mahogany

CCM305CAL\_ CCM305CAR\_  
 3'0" x 6'8" 3'0" x 6'8"



Mahogany

CCM8305CAL\_ CCM8305CAR\_  
 3'0" x 8'0" 3'0" x 8'0"



Mahogany

CCM306CAL\_ CCM306CAR\_  
 3'0" x 6'8" 3'0" x 6'8"



Mahogany

CCM8306CAL\_ CCM8306CAR\_  
 3'0" x 8'0" 3'0" x 8'0"

LOW-E



Mahogany

CCR04020 CCR804020  
 3'0" x 6'8" 3'0" x 8'0"  
 3'6" x 8'0"



Mahogany

CCR20520 CCR820520  
 3'0" x 6'8" 3'0" x 8'0"  
 3'6" x 8'0"



Mahogany

CCR20020 CCR820020  
 3'0" x 6'8" 3'0" x 8'0"



Mahogany

CCR822220  
 3'0" x 8'0"  
 3'6" x 8'0"



Mahogany

CCR804030  
 3'0" x 8'0"



Mahogany

CCR820530  
 3'0" x 8'0"



Mahogany

CCR820030  
 3'0" x 8'0"

# 2/3 Lites

continued



**Mahogany Grain**  
Formerly Classic-Craft  
Mahogany & Rustic

Canvas

## Key

- Flush-Glazed Glass with Square Sticking (FG)
- Low-E Glass (LE)
- Simulated Divided Lites (SDLF6)

## Optional Accessories



Clavos



Strap Hinge

LOW-E



**Mahogany**

CCR820530A  
 3'0" x 8'0"



**Mahogany**

CCR820030A  
 3'0" x 8'0"



**Canvas**

CCV20520 | CCV820520  
 3'0" x 6'8" | 3'0" x 8'0"



**Canvas**

CCV22020 | CCV822020  
 3'0" x 6'8" | 3'0" x 8'0"



**Canvas**

CCV820530  
 3'0" x 8'0"



**Mahogany**

CCM302L | CCM302R  
 3'0" x 6'8" | 3'0" x 6'8"



**Mahogany**

CCM8302L | CCM8302R  
 3'0" x 8'0" | 3'0" x 8'0"



**Mahogany**

CCM304L | CCM304R  
 3'0" x 6'8" | 3'0" x 6'8"

For transoms, see page 102.

Note: Product images show exterior side of door.



Mahogany

CCM8304L | CCM8304R  
 ▲ 🔆 6 | ▲ 🔆 6  
 3'0" x 8'0" | 3'0" x 8'0"



Mahogany

CCM303L | CCM303R  
 ▲ 🔆 6 | ▲ 🔆 6  
 3'0" x 6'8" | 3'0" x 6'8"



Mahogany

CCM8303L | CCM8303R  
 ▲ 🔆 6 | ▲ 🔆 6  
 3'0" x 8'0" | 3'0" x 8'0"



Mahogany

CCM301CAL | CCM301CAR  
 ▲ 🔆 | ▲ 🔆  
 3'0" x 6'8" | 3'0" x 6'8"



Mahogany

CCM8301CAL | CCM8301CAR  
 ▲ 🔆 | ▲ 🔆  
 3'0" x 8'0" | 3'0" x 8'0"



Mahogany

CCM305CAL | CCM305CAR  
 ▲ 🔆 6 | ▲ 🔆 6  
 3'0" x 6'8" | 3'0" x 6'8"



Mahogany

CCM8305CAL | CCM8305CAR  
 ▲ 🔆 6 | ▲ 🔆 6  
 3'0" x 8'0" | 3'0" x 8'0"



Mahogany

CCM306CAL | CCM306CAR  
 ▲ 🔆 6 | ▲ 🔆 6  
 3'0" x 6'8" | 3'0" x 6'8"



Mahogany

CCM8306CAL | CCM8306CAR  
 ▲ 🔆 6 | ▲ 🔆 6  
 3'0" x 8'0" | 3'0" x 8'0"



**Mahogany Grain**  
Formerly Classic-Craft  
Mahogany & Rustic

Canvas

**Key**

- Low-E Glass (LE)
- Black Nickel Caming (1D)
- Brushed Nickel Caming (1C)

**Privacy & Textured Glass Options**

Add the code to the blank in the style number for the desired door and glass combination. For details on glass options, see pages 62-63.

XE = Satin Etch

For transoms, see page 102.

Note: Product images show exterior side of door.



CCM9926  
3'0" x 6'8"



CCV9926  
3'0" x 6'8"



CCM1424  
3'0" x 6'8"



CCV1424  
3'0" x 6'8"



CCV06028  
3'0" x 6'8"



CCM603  
3'0" x 6'8"



CCV06023  
3'0" x 6'8"



CCM612  
3'0" x 6'8"



CCV06022  
3'0" x 6'8"



CCM600XE  
3'0" x 6'8"



CCV06020XE  
3'0" x 6'8"

Note: See page 285 for important product details that may help with your purchase decision.

Right Page: Classic Craft Canvas, Homeward Glass, Door - CCM9926, Sidelites - CCV911SL, Finish - Cabernet



LOW-E



**Mahogany**

CCM600  
\*  
3'0" x 6'8"



**Canvas**

CCV06020  
\*  
3'0" x 6'8"



# Craftsman Lites

## Fir Grain

Formerly Classic-Craft  
American Style

## Canvas

HOMeward™



CCA231  
3'0" x 6'8"  
CCA8231  
3'0" x 8'0"



CCA87132  
3'6" x 8'0"



CCA211  
3'0" x 6'8"  
CCA8211  
3'0" x 8'0"

## Key

- Flush-Glazed Glass with Detailed Sticking (FG)
- Flush-Glazed Glass with Square Sticking (FG)
- Black Nickel Caming (1D)
- Brushed Nickel Caming (1C)
- Simulated Divided Lites (SDL)

## Privacy & Textured Glass Options

Add the code to the blank in the style number for the desired door and glass combination. For details on glass options, see pages 62–63.

XC = Chord      XR = Rainglass  
XJ = Chinchilla    XN = Granite



CCA87112  
3'6" x 8'0"



CCA3401SL  
12" x 6'8"  
14" x 6'8"  
CCA3501SL  
12" x 8'0"  
14" x 8'0"



CCA211SL  
12" x 6'8"  
14" x 6'8"

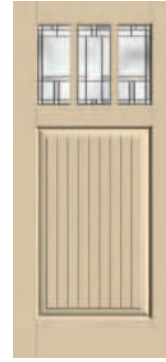

CCA931  
3'0" x 6'8"

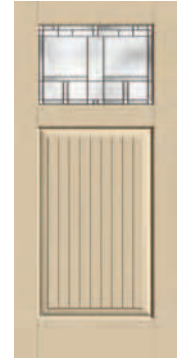

CCA911  
3'0" x 6'8"

## Optional Dentil Shelves

Available for all Classic Craft Craftsman-lite doors.



16-Block Dentil Shelf



4-Block Dentil Shelf



4-Block Dentil Shelf  
Pairs with 3'6" wide doors.



4-Block Dentil Shelf

For transoms, see page 102.

Note: Product images show exterior side of door.

ARBORWATCH®



CCA911SL  
12" x 6'8"  
14" x 6'8"



CCA901SL  
12" x 6'8"  
14" x 6'8"



CCA9300  
3'0" x 6'8"  
CCA89300  
3'0" x 8'0"



CCA87131  
3'6" x 8'0"



**Fir**

CCA9100  
3'0" x 6'8"

CCA89100  
3'0" x 8'0"



**Fir**

CCA87111  
3'6" x 8'0"



**Fir**

CCA1423SL  
12" x 6'8"  
14" x 6'8"

CCA81423SL  
12" x 8'0"  
14" x 8'0"



**Fir**

CCA9100SL  
12" x 6'8"  
14" x 6'8"



**Canvas**

CCV4300  
3'0" x 6'8"



**Canvas**

CCV4100  
3'0" x 6'8"

**PRIVACY & TEXTURED**



**Canvas**

CCV1423SL  
12" x 6'8"  
14" x 6'8"



**Canvas**

CCV4100SL  
12" x 6'8"  
14" x 6'8"



**Fir**

CCA220  
3'0" x 6'8"

CCA8220  
3'0" x 8'0"



**Fir**

CCA87200XR  
3'6" x 8'0"



**Fir**

CCA230  
3'0" x 6'8"

CCA8230  
3'0" x 8'0"



**Fir**

CCA87300XR  
3'6" x 8'0"



**Fir**

CCA240  
3'0" x 6'8"

CCA8240  
3'0" x 8'0"



**Fir**

CCA87400XR  
3'6" x 8'0"



**Fir**

CCA260  
3'0" x 6'8"

CCA8260  
3'0" x 8'0"

# Craftsman Lites

continued

## Fir Grain

Formerly Classic-Craft  
American Style

## Canvas

### Key

-  Flush-Glazed Glass with Detailed Sticking (FG)
-  Flush-Glazed Glass with Square Sticking (FG)
-  Low-E Glass (LE)
-  Simulated Divided Lites (SDL)

### Privacy & Textured Glass Options

Add the code to the blank in the style number for the desired door and glass combination. For details on glass options, see pages 62-63.

- XE = Satin Etch**      **XR = Rainglass**
- XC = Chord**        **XN = Granite**
- XJ = Chinchilla**

### Optional Dentil Shelves

Available for all Classic Craft Craftsman-lite doors.



16-Block Dentil Shelf



4-Block Dentil Shelf



4-Block Dentil Shelf  
Pairs with 3'6" wide doors.



4-Block Dentil Shelf

For transoms, see page 102.

Note: Product images show exterior side of door.

## PRIVACY & TEXTURED



Fir

CCA87600XR  
   
3'6" x 8'0"



Fir

CCA210\_\_\*      CCA8210\_\_\*  
        
3'0" x 6'8"      3'0" x 8'0"



Fir

CCA87100XR  
  
3'6" x 8'0"



Fir

CCA3450\_\_SL\*      CCA3560\_\_SL\*  
          
12" x 6'8"      12" x 8'0"  
14" x 6'8"      14" x 8'0"



Fir

CCA3400\_\_SL\*      CCA3500\_\_SL\*  
        
12" x 6'8"      12" x 8'0"  
14" x 6'8"      14" x 8'0"



Fir

CCA220\_\_SL\*  
   
12" x 6'8"  
14" x 6'8"



Fir

CCA210\_\_SL\*  
  
12" x 6'8"  
14" x 6'8"



Canvas

CCV920\_\_\*  
   
3'0" x 6'8"



Canvas

CCV930\_\_\*  
   
3'0" x 6'8"



Canvas

CCV940\_\_\*  
   
3'0" x 6'8"



Canvas

CCV960\_\_\*  
   
3'0" x 6'8"

\*Not available with Satin Etch (XE) glass.

Note: See page 285 for important product details that may help with your purchase decision.



Canvas

CCV910\_\*  
 3'0" x 6'8"



Canvas

CCV950\_SL  
 12" x 6'8"  
 14" x 6'8"



Canvas

CCV100\_SL  
 12" x 6'8"  
 14" x 6'8"



Canvas

CCV8100\_SL\*  
 12" x 8'0"  
 14" x 8'0"



Canvas

CCV920\_SL\*  
 12" x 6'8"  
 14" x 6'8"



Canvas

CCV910\_SL\*  
 12" x 6'8"  
 14" x 6'8"

LOW-E



Fir

CCA220  
 3'0" x 6'8"



Fir

CCA8220  
 3'0" x 8'0"



Fir

CCA87200  
 3'6" x 8'0"



Fir

CCA230  
 3'0" x 6'8"

CCA8230  
 3'0" x 8'0"

CCA87300  
 3'6" x 8'0"



Fir

CCA240  
 3'0" x 6'8"



Fir

CCA8240  
 3'0" x 8'0"

CCA87400  
 3'6" x 8'0"



Fir

CCA260  
 3'0" x 6'8"

CCA8260  
 3'0" x 8'0"



Fir

CCA87600  
 3'6" x 8'0"

# Craftsman Lites





continued

## Fir Grain

Formerly Classic-Craft  
American Style

## Canvas

### Key

-  Flush-Glazed Glass with Detailed Sticking (FG)
-  Flush-Glazed Glass with Square Sticking (FG)
-  Low-E Glass (LE)
-  Simulated Divided Lites (SDL)

### Optional Dentil Shelves

Available for all Classic Craft  
Craftsman-lite doors.



#### 16-Block Dentil Shelf



#### 4-Block Dentil Shelf



#### 4-Block Dentil Shelf

Pairs with 3'6" wide doors.



#### 4-Block Dentil Shelf

For transoms, see page 102.

Note: Product images show  
exterior side of door.

LOW-E



Fir

CCA210  
   
3'0" x 6'8"

CCA8210  
   
3'0" x 8'0"



Fir

CCA87100  
   
3'6" x 8'0"



Fir

CCA3450SL  
    
12" x 6'8"  
14" x 6'8"

CCA3560SL  
    
12" x 8'0"  
14" x 8'0"



Fir

CCA3400SL  
   
12" x 6'8"  
14" x 6'8"

CCA3500SL  
    
12" x 8'0"  
14" x 8'0"



Fir

CCA220SL  
    
12" x 6'8"  
14" x 6'8"



Fir

CCA210SL  
   
12" x 6'8"  
14" x 6'8"



Canvas

CCA920  
    
3'0" x 6'8"



Canvas

CCA930  
    
3'0" x 6'8"



Canvas

CCA940  
    
3'0" x 6'8"

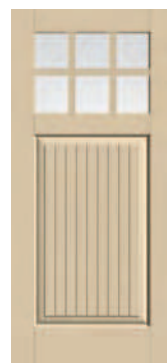

Canvas

CCA960  
    
3'0" x 6'8"



Canvas

CCA910  
    
3'0" x 6'8"

Note: See page 285 for important product details that may help with your purchase decision.

Right Page: Classic Craft Fir Grain, Low-E Glass with SDLs, Door - CCA230, Sidelites - CCA3400SL, Finish - Raven



Canvas

CCV950SL	CCV8950SL
🔹 🌞 🏠	🔹 🌞 🏠
12" x 6'8"	12" x 8'0"
14" x 6'8"	14" x 8'0"



Canvas

CCV100SL	CCV8100SL
🔹 🌞 🏠	🔹 🌞 🏠
12" x 6'8"	12" x 8'0"
14" x 6'8"	14" x 8'0"



Canvas

CCV9020SL
🔹 🌞 🏠
12" x 6'8"
14" x 6'8"



Canvas

CCV9010SL
🔹 🌞 🏠
12" x 6'8"
14" x 6'8"











# Solid Panels

## Fir Grain

Formerly Classic-Craft  
American Style

### Key

-  Flush-Glazed Glass with Square Sticking (FG)
-  Black Nickel Caming (1D)
-  Brushed Nickel Caming (1C)
-  Door Divider Bars (DDBF3)
-  Door Divider Bars (DDBF4)
-  Door Divider Bars (DDBF5)
-  WBDR Options
-  Elevated 10" Bottom Rail Options



Fir

CCA1125  
3'0" x 6'8"

CCA81125  
3'0" x 8'0"



Fir

CCA1149  
3'0" x 6'8"

CCA81149  
3'0" x 8'0"



Fir

CCA1127  
3'0" x 6'8"

CCA81127  
3'0" x 8'0"



Fir

CCA4905  
3'0" x 6'8"

CCA84905  
3'0" x 8'0"

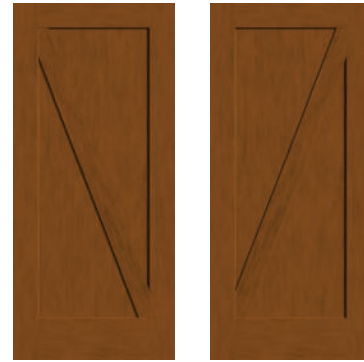

Fir

CCA4915L  
3'0" x 6'8"

CCA4915R  
3'0" x 6'8"

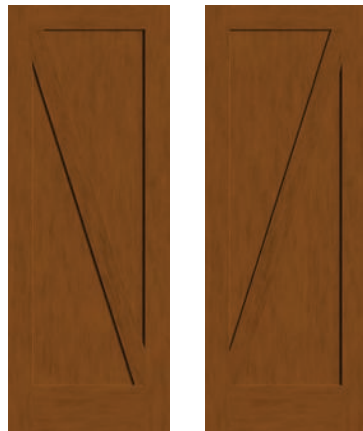

Fir

CCA84915L  
3'0" x 8'0"

CCA84915R  
3'0" x 8'0"



Fir

CCA4925L  
3'0" x 6'8"

CCA4925R  
3'0" x 6'8"

For transoms, see page 102.

Note: Product images show exterior side of door.





Fir

CCA84925L | CCA84925R  
 3 9 E | 3 9 E  
 3'0" x 8'0" | 3'0" x 8'0"



Fir

CCA4935 | CCA84935  
 3 9 | 3 9 E  
 3'0" x 6'8" | 3'0" x 8'0"



Fir

CCA4945 | CCA84945  
 3 9 | 3 9 E  
 3'0" x 6'8" | 3'0" x 8'0"



Fir

CCA1166 | CCA81166  
 3 9 | 3 9 E  
 3'0" x 6'8" | 3'0" x 8'0"



Fir

CCA1158 | CCA81158  
 3 9 | 3 9 E  
 3'0" x 6'8" | 3'0" x 8'0"



Fir

CCA1147 | CCA81147  
 3 9 | 3 9 E  
 3'0" x 6'8" | 3'0" x 8'0"

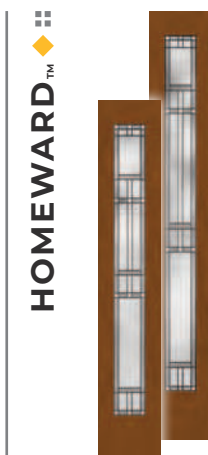

HOMEWARD™

Fir

CCA2420SL | CCA82420SL  
 12" x 6'8" | 12" x 8'0"  
 14" x 6'8" | 14" x 8'0"

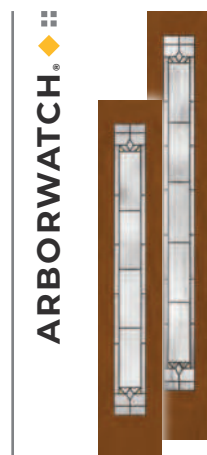

ARBORWATCH™

Fir

CCA2410SL | CCA82410SL  
 12" x 6'8" | 12" x 8'0"  
 14" x 6'8" | 14" x 8'0"

Pair full-lite Shaker flush-glazed sidelites, also available in privacy and textured and Low-E glass, with solid-panel doors for natural light in the entry.



Fir

CCA1100 | CCA81100  
 9 | 9 E  
 3'0" x 6'8" | 3'0" x 8'0"



Fir

CCA1133 | CCA81133  
 4 9 | 4 9 E  
 3'0" x 6'8" | 3'0" x 8'0"



Fir

CCA1145 | CCA81145  
 4 9 | 4 E 9  
 3'0" x 6'8" | 3'0" x 8'0"



Fir

CCA1150 | CCA81150  
 3 9 | 3 9 E  
 3'0" x 6'8" | 3'0" x 8'0"

# Solid Panels



Walnut Grain

## Key

-  Low-E Glass (LE)
-  WBDR Options
-  Elevated 10" Bottom Rail Options





Walnut

<b>CCW1000</b> 	<b>CCW81000</b> 
2'6" x 6'8" (7'0")	2'6" x 8'0"
2'8" x 6'8" (7'0")	2'8" x 8'0"
2'10" x 6'8" (7'0")	2'10" x 8'0"
3'0" x 6'8" (7'0")	3'0" x 8'0"
3'6" x 6'8" (7'0")	3'6" x 8'0"





Walnut

<b>CCW900L</b> 	<b>CCW8900L</b> 
2'6" x 6'8" (7'0")	2'6" x 8'0"
2'8" x 6'8" (7'0")	2'8" x 8'0"
2'10" x 6'8" (7'0")	2'10" x 8'0"
3'0" x 6'8" (7'0")	3'0" x 8'0"
3'6" x 6'8" (7'0")	3'6" x 8'0"





Walnut

<b>CCW900R</b> 	<b>CCW8900R</b> 
2'6" x 6'8" (7'0")	2'6" x 8'0"
2'8" x 6'8" (7'0")	2'8" x 8'0"
2'10" x 6'8" (7'0")	2'10" x 8'0"
3'0" x 6'8" (7'0")	3'0" x 8'0"
3'6" x 6'8" (7'0")	3'6" x 8'0"





Walnut

<b>CCW901L</b> 	<b>CCW8901L</b> 
2'6" x 6'8" (7'0")	2'6" x 8'0"
2'8" x 6'8" (7'0")	2'8" x 8'0"
2'10" x 6'8" (7'0")	2'10" x 8'0"
3'0" x 6'8" (7'0")	3'0" x 8'0"
3'6" x 6'8" (7'0")	3'6" x 8'0"



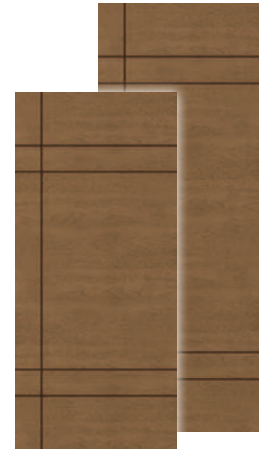

Walnut

<b>CCW901R</b> 	<b>CCW8901R</b> 
2'6" x 6'8" (7'0")	2'6" x 8'0"
2'8" x 6'8" (7'0")	2'8" x 8'0"
2'10" x 6'8" (7'0")	2'10" x 8'0"
3'0" x 6'8" (7'0")	3'0" x 8'0"
3'6" x 6'8" (7'0")	3'6" x 8'0"



Walnut

<b>CCW902L</b> 	<b>CCW8902L</b> 
2'6" x 6'8" (7'0")	2'6" x 8'0"
2'8" x 6'8" (7'0")	2'8" x 8'0"
2'10" x 6'8" (7'0")	2'10" x 8'0"
3'0" x 6'8" (7'0")	3'0" x 8'0"
3'6" x 6'8" (7'0")	3'6" x 8'0"



For transoms, see page 102.

Note: Product images show exterior side of door.

Note: See page 285 for important product details that may help with your purchase decision.

Bottom: Classic Craft Walnut Grain Door – CCW902R; Low-E Glass Direct Set Sidelites – DRS2131SL, Transoms – 19200T, 19210T, Finish – Shale

Right Page: Classic Craft Walnut Grain Door – CCW8901L; Low-E Glass Direct Set Sidelites – DRS82131SL, Finish – Tumbleweed

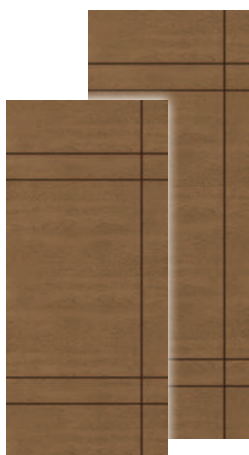

Walnut

<b>CCW902R</b> 6	<b>CCW8902R</b> 6
2'6" x 6'8" (7'0")	2'6" x 8'0"
2'8" x 6'8" (7'0")	2'8" x 8'0"
2'10" x 6'8" (7'0")	2'10" x 8'0"
3'0" x 6'8" (7'0")	3'0" x 8'0"
3'6" x 6'8" (7'0")	3'6" x 8'0"



Walnut

<b>CCW903</b> 6	<b>CCW8903</b> 6
2'6" x 6'8" (7'0")	2'6" x 8'0"
2'8" x 6'8" (7'0")	2'8" x 8'0"
2'10" x 6'8" (7'0")	2'10" x 8'0"
3'0" x 6'8" (7'0")	3'0" x 8'0"
3'6" x 6'8" (7'0")	3'6" x 8'0"

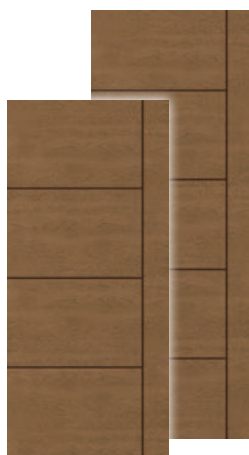

Walnut

<b>CCW904L</b> 6	<b>CCW8904L</b> 6
2'6" x 6'8" (7'0")	2'6" x 8'0"
2'8" x 6'8" (7'0")	2'8" x 8'0"
2'10" x 6'8" (7'0")	2'10" x 8'0"
3'0" x 6'8" (7'0")	3'0" x 8'0"
3'6" x 6'8" (7'0")	3'6" x 8'0"

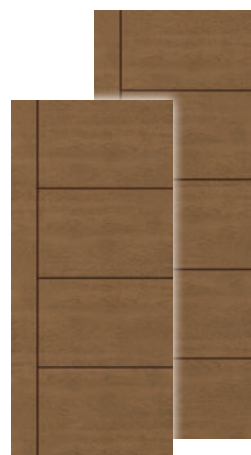

Walnut

<b>CCW904R</b> 6	<b>CCW8904R</b> 6
2'6" x 6'8" (7'0")	2'6" x 8'0"
2'8" x 6'8" (7'0")	2'8" x 8'0"
2'10" x 6'8" (7'0")	2'10" x 8'0"
3'0" x 6'8" (7'0")	3'0" x 8'0"
3'6" x 6'8" (7'0")	3'6" x 8'0"



Walnut

<b>CCW905</b> 6E	<b>CCW8905</b> 6E
2'6" x 6'8" (7'0")	2'6" x 8'0"
2'8" x 6'8" (7'0")	2'8" x 8'0"
2'10" x 6'8" (7'0")	2'10" x 8'0"
3'0" x 6'8" (7'0")	3'0" x 8'0"
3'6" x 6'8" (7'0")	3'6" x 8'0"



Walnut

<b>CCW906L</b> 6	<b>CCW8906L</b> 6
2'6" x 6'8" (7'0")	2'6" x 8'0"
2'8" x 6'8" (7'0")	2'8" x 8'0"
2'10" x 6'8" (7'0")	2'10" x 8'0"
3'0" x 6'8" (7'0")	3'0" x 8'0"
3'6" x 6'8" (7'0")	3'6" x 8'0"

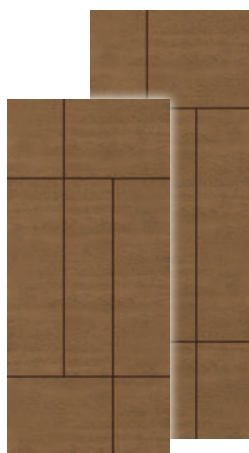

Walnut

<b>CCW906R</b> 6	<b>CCW8906R</b> 6
2'6" x 6'8" (7'0")	2'6" x 8'0"
2'8" x 6'8" (7'0")	2'8" x 8'0"
2'10" x 6'8" (7'0")	2'10" x 8'0"
3'0" x 6'8" (7'0")	3'0" x 8'0"
3'6" x 6'8" (7'0")	3'6" x 8'0"



Walnut

<b>CCW907L</b> 6	<b>CCW8907L</b> 6
2'6" x 6'8" (7'0")	2'6" x 8'0"
2'8" x 6'8" (7'0")	2'8" x 8'0"
2'10" x 6'8" (7'0")	2'10" x 8'0"
3'0" x 6'8" (7'0")	3'0" x 8'0"
3'6" x 6'8" (7'0")	3'6" x 8'0"



Walnut

<b>CCW907R</b> 6	<b>CCW8907R</b> 6
2'6" x 6'8" (7'0")	2'6" x 8'0"
2'8" x 6'8" (7'0")	2'8" x 8'0"
2'10" x 6'8" (7'0")	2'10" x 8'0"
3'0" x 6'8" (7'0")	3'0" x 8'0"
3'6" x 6'8" (7'0")	3'6" x 8'0"

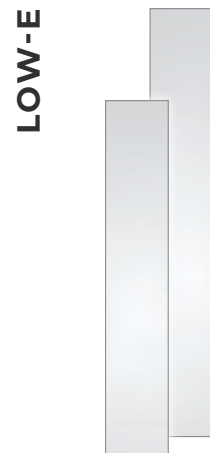

Direct Set

<b>DRS2131SL</b> *	<b>DRS82131SL</b> *
12" x 6'8" (7'0")	12" x 8'0"
14" x 6'8" (7'0")	14" x 8'0"





# Solid Panels

## Mahogany Grain

Formerly Classic-Craft  
Mahogany & Rustic

Canvas

### Key

-  Flush-Glazed Glass with Square Sticking (FG)
-  Simulated Divided Lites (SDL)
-  Simulated Divided Lites (SDLF6)
-  WBD Options
-  WBD / HVHZ Options

### Optional Accessories

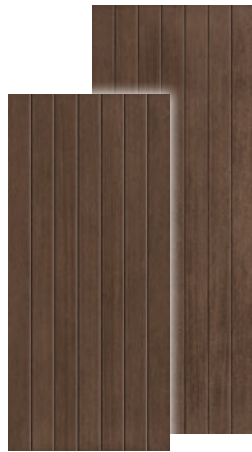
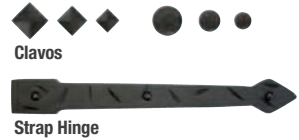

Mahogany

CCR100 | CCR8100  
3'0" x 6'8" | 3'0" x 8'0"  
3'6" x 6'8" | 3'6" x 8'0"



Mahogany

CCM890  
3'0" x 8'0"



Mahogany

CCR8222  
3'0" x 8'0"  
3'6" x 8'0"



Mahogany

CCR100R | CCR8100R  
3'0" x 6'8" | 3'0" x 8'0"  
3'6" x 6'8" | 3'6" x 8'0"



Mahogany

CCR8005A  
3'0" x 8'0"



Mahogany

CCR205A | CCR8205A  
3'0" x 6'8" | 3'0" x 8'0"  
3'6" x 6'8" | 3'6" x 8'0"



Mahogany

CCR200A | CCR8200A  
3'0" x 6'8" | 3'0" x 8'0"



Mahogany

CCR8225  
3'0" x 8'0"  
3'6" x 8'0"



Mahogany

CCR8005  
3'0" x 8'0"

For transoms, see page 102.

Note: Product images show exterior side of door.



Mahogany

CCR040  
3'0" x 6'8"

CCR8040  
3'0" x 8'0"  
3'6" x 8'0"



Mahogany

CCR205  
3'0" x 6'8"

CCR8205  
3'0" x 8'0"  
3'6" x 8'0"



Mahogany

CCR200  
3'0" x 6'8"

CCR8200  
3'0" x 8'0"



Mahogany

CCM60  
3'0" x 6'8"

HAMMERED



Mahogany

CCR2025XHSL  
12" x 6'8"  
14" x 6'8"

CCR82035XHSL  
12" x 8'0"  
14" x 8'0"



Canvas

CCV200  
3'0" x 6'8"



Canvas

CCV205  
3'0" x 6'8"

CCV8205  
3'0" x 8'0"



Canvas

CCV220  
3'0" x 6'8"

CCV8220  
3'0" x 8'0"



Canvas

CCV831  
3'0" x 8'0"



Canvas

CCV060  
3'0" x 6'8"



Canvas

CCV050  
3'0" x 6'8"

HAMMERED



Canvas

CCV950XHSL  
12" x 6'8"  
14" x 6'8"

CCV8950XHSL  
12" x 8'0"  
14" x 8'0"

# Transoms

Transoms can be stained or painted to match Classic Craft® door systems.

## HOMeward™ ◆ ◆



**HWRT**  
3'0" door + (2) 12" sidelites  
3'0" door + (2) 14" sidelites  
Continuous Sill Systems Only



**HW30T**  
3'0" Door Only

## ARBORWATCH® ◆ ◆



**ABRT**  
3'0" door + (2) 12" sidelites  
3'0" door + (2) 14" sidelites  
Continuous Sill Systems Only



**AB30T**  
3'0" Door Only

## LONGFORD™ ◆ ◆



**LFET**  
3'0" door + (2) 12" sidelites  
3'0" door + (2) 14" sidelites  
Continuous Sill Systems Only



**LFRT**  
3'0" door + (2) 12" sidelites  
3'0" door + (2) 14" sidelites  
Continuous Sill Systems Only



**LF30T**  
3'0" Door Only

## PROVINCIAL™ ◆ ◆

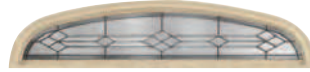

**CC040T**  
3'0" door + (2) 12" sidelites  
3'0" door + (2) 14" sidelites  
Continuous Sill Systems Only

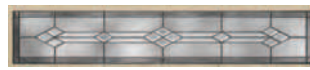

**CC420T**  
3'0" door + (2) 12" sidelites  
3'0" door + (2) 14" sidelites  
Continuous Sill Systems Only

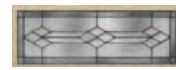

**CC400T**  
3'0" Door Only

## LUCERNA® ◆ ◆



**LCET**  
3'0" door + (2) 12" sidelites  
3'0" door + (2) 14" sidelites  
Continuous Sill Systems Only



**LCRT**  
3'0" door + (2) 12" sidelites  
3'0" door + (2) 14" sidelites  
Continuous Sill Systems Only



**LC30T**  
3'0" Door Only

## ZAHA® ◆ ◆



**ZHRT**  
3'0" door + (2) 12" sidelites  
3'0" door + (2) 14" sidelites  
Continuous Sill Systems Only

## LOW-E



Grille Sticks Applied



**19020T**  
\*  
3'0" door + (2) 12" sidelites  
Continuous Sill Systems Only  
3'0" door + (2) 14" sidelites  
Continuous / Boxed Sill Systems



Grille Sticks Applied



**19220T**  
\*  
3'0" door + (2) 12" sidelites  
3'0" door + (2) 14" sidelites  
Continuous / Boxed Sill Systems



Grille Sticks Applied



**19200T**  
\*  
3'0" Door Only



**19210T**  
\*  
12" & 14"  
Sidelite Only

### Key

- ☀ Low-E Glass (LE)
- ◆ Black Nickel Caming (1D)
- ◆ ◆ Brushed Nickel Caming (1C)

Note: See page 285 for important product details that may help with your purchase decision.

Right Page: Classic Craft Canvas, Homeward Glass, Door – CCV9925, Sidelites – CCV911SL, Transom – HWRT



# Classic Craft® Hinged Patio Doors



## A premium entrance to outdoor living.

The unmatched craftsmanship of Classic Craft premium entryways extends to the patio as an uncompromising entrance to the outdoors. Select from remarkably authentic wood grains and premium smooth surfaces to create a seamless indoor-outdoor connection.

Note: Finish colors may vary from an actual application due to fluctuations in finishing or printing. See your Therma-Tru seller or visit [thermatru.com](http://thermatru.com) for details on limited warranties and exclusions, and ENERGY STAR qualified products.

Top: Classic Craft Mahogany Grain, Low-E Glass, Doors – CCM82800, Sidelites – CCR8000SL, Finish – Lynx



## GRAIN & TEXTURE OPTIONS

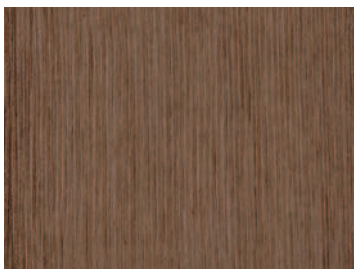

**Fir Grain**  
Formerly Classic-Craft American Style

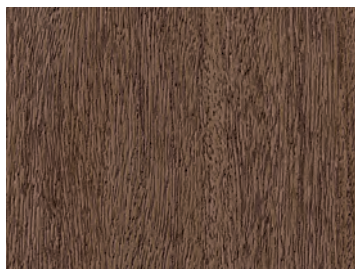

**Mahogany Grain**  
Formerly Classic-Craft Mahogany & Rustic



**Canvas**

## GLASS OPTIONS



**Low-E Glass**



**Flush-Glazed Glass**

Glass built directly into the door during the manufacturing process offers a seamless appearance, wider daylight opening and high-performance weather seal.

### EnLiten™ Flush-Glazed Warranty Riders

See page 123 for details on the EnLiten Flush-Glazed Rider for Construction & Installation, and the EnLiten Flush-Glazed Rider for Homeowners.

■ = Available		Classic Craft
<b>Door Selections</b>		
Material		Fiberglass
Warranty		1x Transferable Lifetime
Finish Options		Stain or Paint
<b>Flush-Glazed Glass Selections</b>		
Low-E Glass with and without Divided Lites 🔥	■	
Privacy & Textured Glass with and without Divided Lites 🔥	■	
<b>Lip-Lite Glass Selections</b>		
Low-E Glass with and without Divided Lites	■	
Privacy & Textured Glass with and without Divided Lites	■	
<b>Available Sizes</b>		
Heights		6'8", 8'0"
Single Widths		3'0"
Double Widths		6'0"
Triple Widths		9'0"
Retrofit Openings		
<b>Additional Options</b>		
Screens & Screen Accessories Available Colors: Bronze, White		2" Frame, 3" Frame
Impact-Rated Options		
Tru-Defense Eligible	■	

## AVAILABLE CONFIGURATIONS

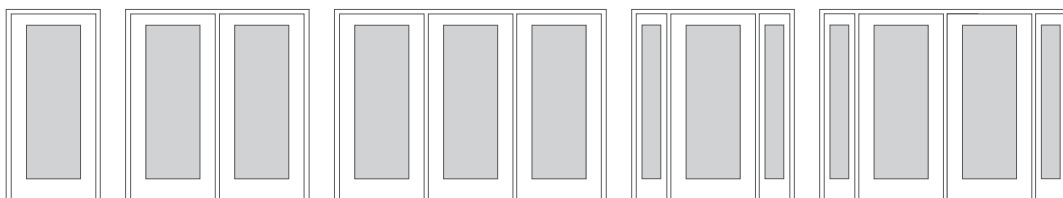

## EnLiten™ Flush-Glazed Low-E Glass



### AVAILABLE COLLECTIONS

- Classic Craft® Fir Grain
- Classic Craft® Mahogany Grain

### AVAILABLE DOOR STYLES



### AVAILABLE CONFIGURATIONS

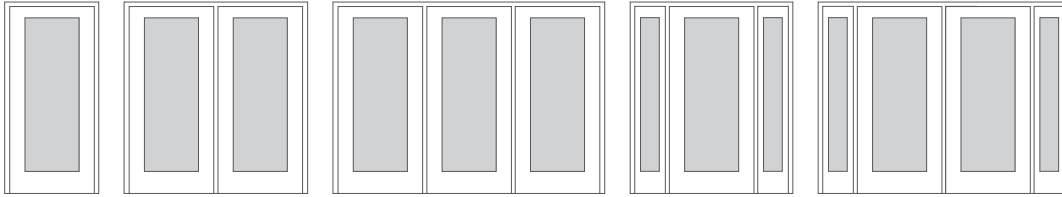

## EnLiten™ Flush-Glazed Low-E Glass with Divided Lites



### AVAILABLE COLLECTIONS

- Classic Craft® Mahogany Grain

### AVAILABLE DOOR STYLES

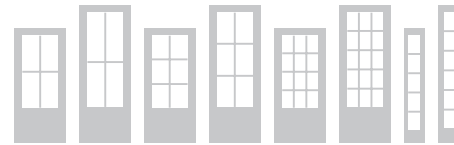

### AVAILABLE CONFIGURATIONS

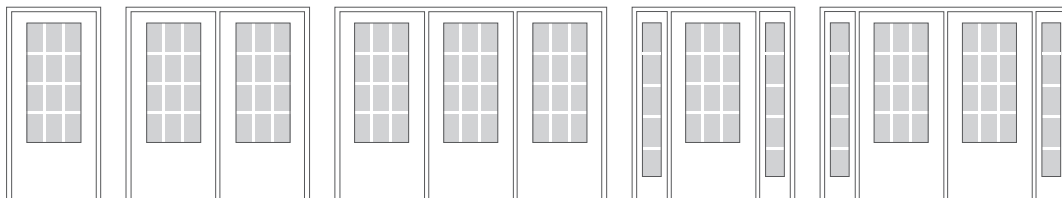

Note: See page 287 for important product details that may help with your purchase decision.

Right Page: Classic Craft Fir Grain, Low-E Glass, Doors – CCA82400, Finish – Acorn, Retractable Screens – White

# Low-E Glass



## AVAILABLE COLLECTIONS

- Classic Craft® Mahogany Grain
- Classic Craft® Canvas

## AVAILABLE DOOR STYLES

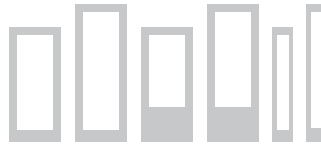

## AVAILABLE CONFIGURATIONS

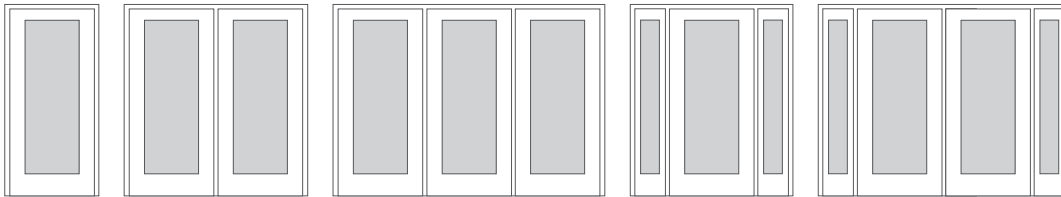

# Fiber-Classic® & Smooth-Star® Fiberglass Doors

Fiber-Classic® & Smooth-Star®



## Great style for any home.

With many door styles in common and glass families that cross over between door collections, Fiber-Classic and Smooth-Star offer options to fit virtually every entrance — from front entry to patio to utility doors — at an excellent value.

Top: Fiber-Classic Mahogany Collection, Saratoga Glass, Door - FCM86240,  
Sidelites - FCM86201SL, Finish - Acorn  
Bottom: Fiber-Classic Oak Collection, Internal Blinds, Door - FC678, Finish - Barley  
Right Page: Smooth-Star Door - S3501, Finish - Golden Wheat

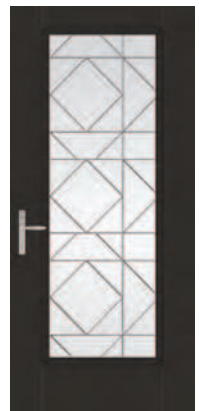

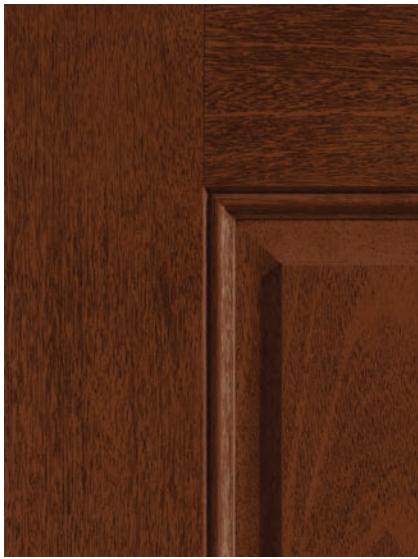

### Fiber-Classic® Mahogany Collection™

Fiber-Classic Mahogany complements rich wood tones in home interiors, extending the look to the outside with beauty and elegance.



### Fiber-Classic® Oak Collection™

Fiber-Classic Oak is the door that started the fiberglass revolution and features the warm look and feel of natural Oak graining.



### Smooth-Star®

Smooth-Star fiberglass doors are ready-to-paint with crisp, clean contours making them the more attractive and durable alternative to steel.



**SEE THE DIFFERENCE  
COLOR CAN MAKE.**

Therma-Tru offers a wide variety of finish options for our doors. Explore PrismaGuard® premium finish and Same-Day® Stain color options on pages 258–264.

## Glass Options

- Explore a portfolio of interchangeable decorative glass designs, and privacy and textured glass options starting on page 114.
- Lite frame options include Advanta™ lite frame with no screw plugs and a standard Lip-lite frame, starting on page 139. Both feature 22" wide glass and are suitable for use with a storm door.
- Welcome even more light into the home with EnLiten™ flush-glazed designs with 25–27" wide glass, starting on page 124.
- Low-E glass is available for internal blinds, divided lites and clear glass, providing exceptional energy efficiency.



# Door Construction

Fiber-Classic® and Smooth-Star® doors set the standard for beauty, quality and performance at an excellent value. Explore the craftsmanship and innovation of doors designed for long-lasting energy efficiency, durability and security.



## 1 WEATHER RESISTANCE

Composite rails protect the door at the top and bottom edges to help block moisture that can wick into doors.

## 2 SECURITY

Our fiberglass door slabs are up to 30% more resistant to kick-ins than standard steel doors.\* Our Fiber-Classic and Smooth-Star doors feature an enhanced lock block combined with a 1-1/4" engineered lumber lock stile which increases rigidity and stability.

## 3 DURABILITY



With very little maintenance, a fiberglass door can bring a home years of durability. Unlike wood, fiberglass will not warp or rot. And, unlike steel, it will not dent or rust.

## 4 R-VALUES

Built with a polyurethane foam core that offers up to four times the insulating R-Value of wood\*\*, Therma-Tru® fiberglass doors insulate against cold and heat for exceptional energy efficiency.

\*Comparison of pendulum impact test results for Therma-Tru doors in steel versus fiberglass. Visit [thermatru.com](http://thermatru.com) for details.  
\*\*Comparison of fiberglass to wood doors (both without glass).

## Additional Options



-  WBDR Options: Look for this icon to find door styles that can be configured for WBDR.\*
-  WBDR / HVHZ Options: Look for this icon to find door styles that can be configured for WBDR or HVHZ.\*
-  Fire-Rated Options: Available on solid-panel doors. See pages 240–243.

**Flush-Glazed Options:** Look for these icons (🔺🔻) to find doors styles with flush-glazed glass. See pages 124–137.

## Warranties



Fiber-Classic and Smooth-Star products are backed by a lifetime limited warranty. See page 285 for more information.

-  Fiber-Classic and Smooth-Star products with flush-glazed glass are also backed by the EnLiten™ Flush-Glazed Rider for Construction & Installation, and the EnLiten™ Flush-Glazed Rider for Homeowners. See page 123 for more information.
-  Fiber-Classic and Smooth-Star door systems are eligible for the Tru-Defense® Warranty Rider when properly assembled and installed with all Therma-Tru® specified system components, in accordance with the Rider. See page 18–19 for details.



	Fiber-Classic® Mahogany Collection™	Fiber-Classic® Oak Collection™	Smooth-Star®
<p>■ = Available                      ◻ = Not Applicable                      S = Stain                      P = Paint</p>			
<b>Door Widths</b>			
2'0"	■	■	■
2'4"	■	■	■
2'6"	■	■	■
2'8"	■	■	■
2'10"	■	■	■
3'0"	■	■	■
3'6"	◻	◻	■
<b>Door Heights</b>			
6'6"	◻	■	■
6'8"	■	■	■
7'0"	■	■	■
8'0"	■	■	■
<b>Glass Options</b>			
Decorative	16	16	16
Privacy & Textured	6	6	6
Internal Blinds	■	■	■
Flush-Glazed	■	■	■
Screen Vented	◻	◻	■
Simulated Divided Lites	■	■	■
Grilles Between Glass	■	■	■
Low-E	■	■	■
Clear	■	■	■
<b>Additional Options</b>			
Finish	S / P	S / P	P
Vented Sidelites	■	■	■

**RETROFIT HINGED PATIO DOORS**

Replacing common slider sizes? Find hinged patio door options in this section. For more about our patio door systems, see pages 210–215.

5'0" Patio Opening = (2) 2'4" Doors  
 6'0" Patio Opening = (2) 2'10" Doors

\*Please verify that there is a Therma-Tru Impact-rated product approval for the configuration before buying.  
 Note: Finish colors may vary from an actual application due to fluctuations in finishing or printing. See your Therma-Tru seller or visit [thermatru.com](http://thermatru.com) for more, including details on limited warranties and exclusions, Riders, ENERGY STAR qualified products and product approvals.

Left: Smooth-Star, Clear Glass, Door – S8140  
 Right Page: Smooth-Star, Granite Glass with SDLs, Door – S2103XN, Sidelites – S2000XNSL





## Vented Sidelites

More than a sidelite. Vented sidelites from Therma-Tru let the homeowner enjoy the added curb appeal of an elegant front entry unobstructed by a screen door. Choose from convenient specialty glass options or eye-catching decorative designs. In fact, only Therma-Tru offers vented sidelites with decorative glass. Look for the (●) icon.

- Sturdy stiles and hinges make the unit work as a small swinging door.
- Wide patio mullions provide dependable operation.
- Multi-point lock and continuous system help provide security and stability.
- Convenient removable screens – available in bronze and white – are designed for worry-free use.

### AVAILABLE SIZES

Height	Width	
	12"	14"
6'6"	■	■
6'8"	■	■
8'0"		■



### AVAILABLE CONFIGURATIONS



Single Door with Vented Sidelites (Inswing Only)



Double Doors with Vented Sidelites (Inswing Only)

# Decorative & Specialty Glass Designs

## Blackstone®

Traditional English design meets **1** clear curved bevels, **2** rainglass and coming to create the distinctive styling of Blackstone. Entries get the best of both privacy and simple refinement.



Black Nickel



Brushed Nickel

## Crystalline™

This time-honored design features geometric styling brought to life with **1** glue chip glass, **2** glue chip bevels, **3** clear bevels and coming. Offering modest privacy, Crystalline is a shining example of traditional decorative glass with lasting beauty.



Black Nickel



Brushed Nickel

## Sedona

Art meets glass in Sedona where Arts and Crafts simplicity is designed with **1** slump glass, **2** clear bevels, **3** clear artique glass and coming.

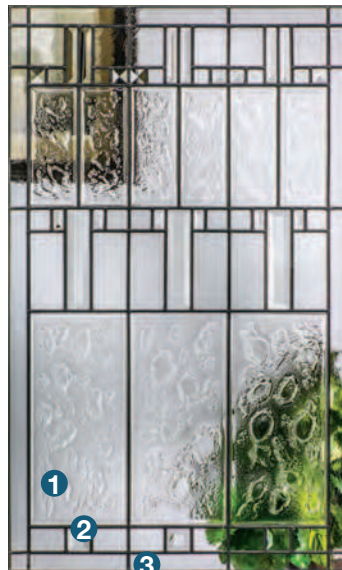

Black Nickel



Brushed Nickel

Note: Glass privacy ratings may be more or less than indicated, based on glass design and size of glass. Glass designs may differ from depiction due to size and hand craftsmanship of glass. See your Therma-Tru seller or visit [thermatru.com](http://thermatru.com) for details on glass privacy ratings and designs.

## Salinas®

1 Oceana glass and wrought iron come together to create a cheerful entry glass design that offers the ultimate in privacy with yesterday's charm.

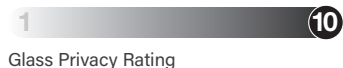

Glass Privacy Rating

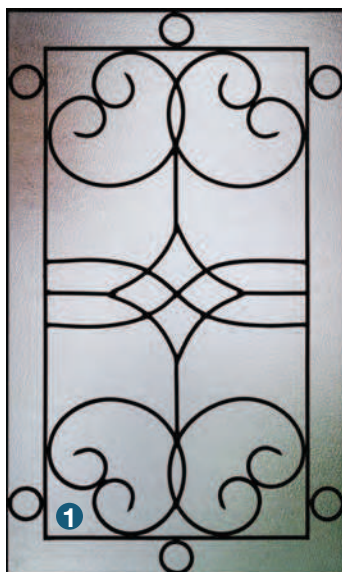

Wrought Iron

## Maple Park®

With hints of Mission style and the American Southwest, Maple Park provides a sophisticated appearance with 1 waterglass, 2 clear bevels, 3 granite glass and caming. The curved design adds unique appeal.



Glass Privacy Rating



Black Nickel



Brushed Nickel

## Saratoga™

Saratoga evokes a certain urban sophistication while offering modest privacy with its 1 clear bevels, 2 diamond glass, 3 reeded glass and caming. The geometric pattern bridges both modern and traditional designs.



Glass Privacy Rating



Black Nickel

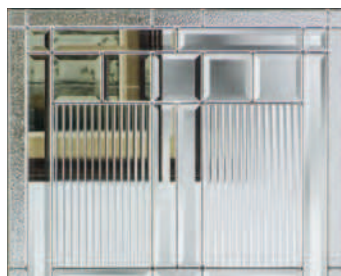

Brushed Nickel

## Texas Star

Beautifully crafted with **1** clear bevels, **2** curved bevels, **3** clear waterglass, **4** granite glass, **5** glue chip glass, there's no mistaking the inspiration for this recognizable design. Strong, independent and all-American.



Black Nickel



Brushed Nickel

## Wellesley™

Simple yet charming, Wellesley's Victorian-inspired design uses **1** clear baroque glass, **2** clear curved bevels, **3** waterglass, **4** granite glass and coming to add beauty to any entry.



Black Nickel



Brushed Nickel



Brass

## Riserva®

Riserva decorative glass features a combination of linear and curved wrought iron elements that create a simple yet graceful design. Riserva features **1** oceana glass for privacy with a look that enhances a wide variety of home styles, including Mediterranean, Old World and Southwest.

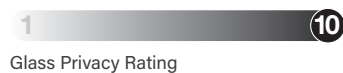

Wrought Iron

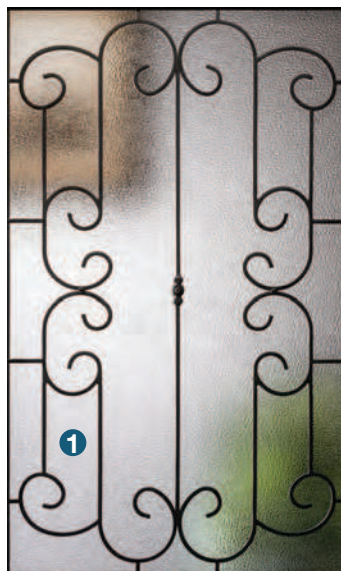

\*Brass coming not available for Impact-rated products.

Note: Glass privacy ratings may be more or less than indicated, based on glass design and size of glass. Glass designs may differ from depiction due to size and hand craftsmanship of glass. See your Therma-Tru seller or visit [thermatru.com](http://thermatru.com) for details on glass privacy ratings and designs.

## Concorde™

There's just something friendly about Concorde's cheery four-leaf design.

① Glue chip glass, ② clear curved bevels, ③ clear glass and coming make up its Old World charm.



Black Nickel



Brushed Nickel



Brass

## Kensington™

Kensington speaks European elegance while offering modest privacy with its

① clear bevels, ② glue chip glass, ③ granite glass and coming.

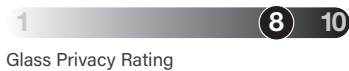

Black Nickel



Brushed Nickel

## Pembridge™

Simplistic in its design, Pembridge features a field of ① hammered glass framed by ② gray baroque glass and ③ multifaceted bevels. A central diamond shape adds a decorative touch.



Black Nickel

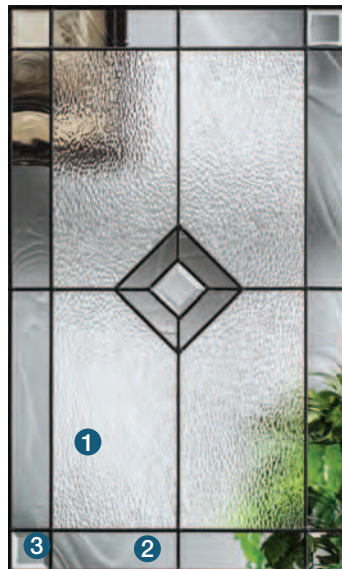

Brushed Nickel



Brass\*

Note: The use of gray baroque glass varies based on glass size.

## Axis®

Simple and smart, Axis combines **1** narrow reeded glass in horizontal and vertical arrangements to create contrast and modest privacy. A vertical band of **2** clear glass bevels completes this linear design, ideal for Modern home styles.

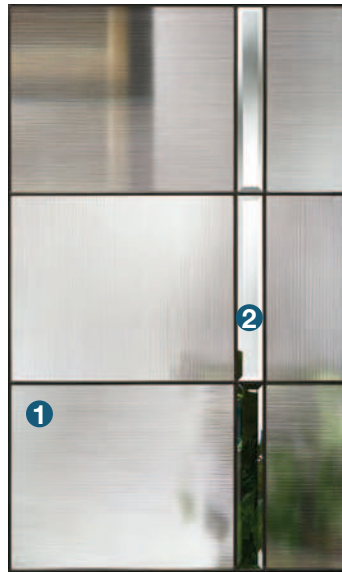

Black Nickel

## Calix

Calix includes an on-trend "x" design and a delicate diamond pattern with **1** clear glass, providing fine-lined geometric appeal.

**Available with Advanta™ lite frame\* or Impact-rated lite frame only.**



Black Nickel



Brushed Nickel



Brass

## Latitude

Latitude showcases **1** seedy glass and simple curved details in a half-moon geometric design.

**Available with Advanta™ lite frame\* or Impact-rated lite frame only.**



Black Nickel

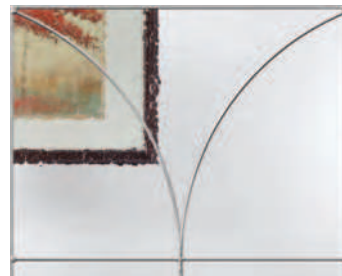

Brushed Nickel



Brass

\*See your Therma-Tru seller for details on product availability.

Note: Glass privacy ratings may be more or less than indicated, based on glass design and size of glass. Glass designs may differ from depiction due to size and hand craftsmanship of glass. See your Therma-Tru seller or visit [thermatru.com](http://thermatru.com) for details on glass privacy ratings and designs.

## Echelon

Echelon provides **1** clear glass accented with eased angles and clean edges infused with elements of diamonds and triangles.

Available with Advanta™ lite frame\* or Impact-rated lite frame only.

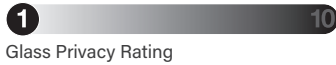

Black Nickel

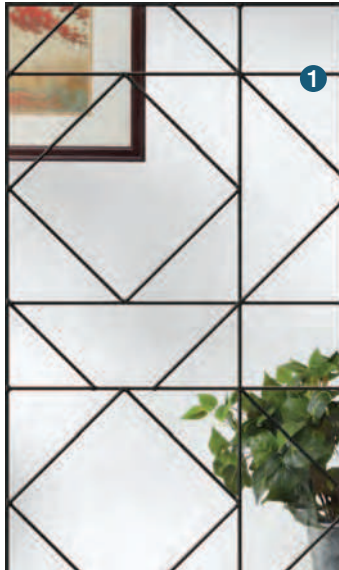

Brushed Nickel



Brass

## Internal Blinds

Internal blinds provide the privacy and convenience of a cordless blind enclosed between glass. A single-hand operator opens, closes and tilts the blinds to control the desired level of privacy and light.

- 1** Single-Hand Operator
- 2** Privacy Bar

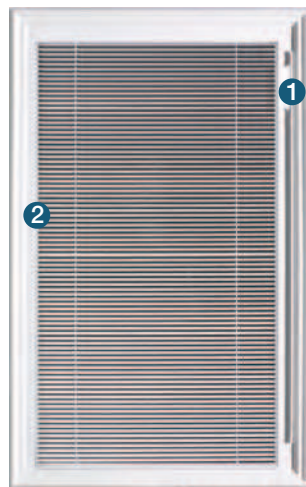

## Screen Vented

Screen vented lites offer a built-in screen for ventilation, featuring a gliding operation and sash locking system.



## Privacy & Textured Glass



**REEDED**

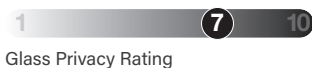

**SATIN ETCH**

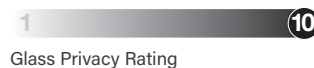

**CHORD**

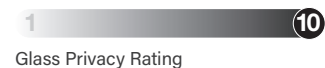

**CHINCHILLA**



**RAINGLASS**



**GRANITE**



Also Available: **Low-E & Clear Glass**

# Divided Lites

Additional grid patterns can be created through our simulated divided lite (SDL) lineal program. See your Therma-Tru seller for details.

Fiber-Classic® & Smooth-Star®

## SIMULATED DIVIDED LITES (SDLS) WITH GRILLES BETWEEN GLASS (GBGS)

Choose wood-grained or smooth-textured SDL bars layered over flat bronze GBG bars to achieve the most authentic divided lite look.

Look for the (    ) icons.

Shown with flat bronze GBGs (recommended).



## SIMULATED DIVIDED LITES (SDLS)

Wood-grained or smooth SDL bars are adhered to the interior and exterior panes of tempered glass. Can be stained or painted any color to complement the door and home.

Look for the (    ) icons.



\*Almond and Bronze GBGs available in flat bars only.

\*\*Available in Special Quote Program.

Note: See page 285 for important product details that may help with your purchase decision.



### GRILLES BETWEEN GLASS (GBGS)

Contour or flat GBG bars are thermally sealed between two panes of tempered glass for the convenience of a smooth, easy-to-clean glass surface.

Look for the (◆◆◆◆) icons.



### FIXED GRILLES

Fixed grilles are molded as part of the lite frame on the interior and exterior panes of tempered glass. Can be stained or painted to complement the home's décor.

Look for the (◆) icon.



### SDL BAR OPTIONS

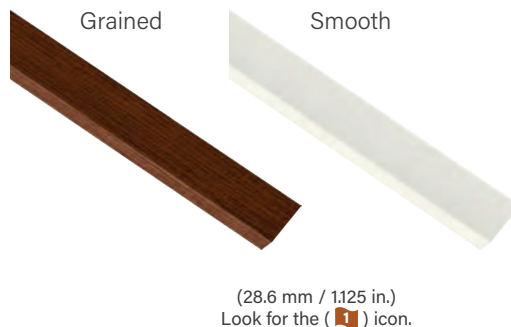
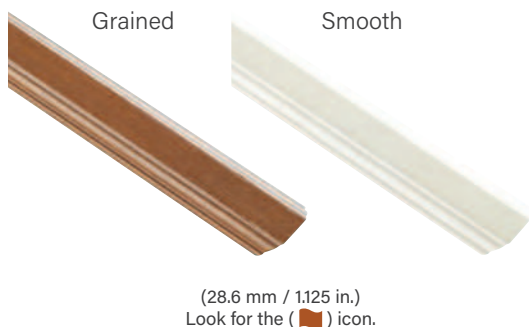

**Smooth SDL bars are color matched to PrismaGuard Alpine.**



### GBG BAR OPTIONS

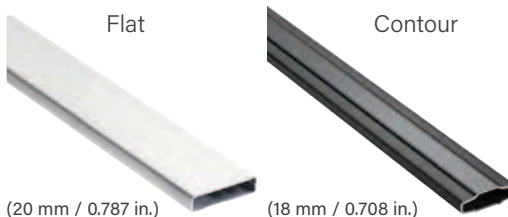

### GBG Color Options

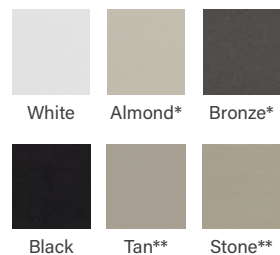

### Key

- Simulated Divided Lites (SDL)
- 1 Simulated Divided Lites (SDLF1)
- 2 Simulated Divided Lites (SDLF2)
- ◆ Flat or Contour White Grilles Between Glass (GBGF / GBGC)
- ◆ Flat Almond Grilles Between Glass (GBGF)
- ◆ Flat Bronze Grilles Between Glass (GBGF)
- ◆ Flat or Contour Black Grilles Between Glass (GBGF / GBGC)
- ◆ Fixed Grilles (FXG)

## Clavos & Strap Hinges

Add a finishing touch of rustic flavor with decorative hardware.

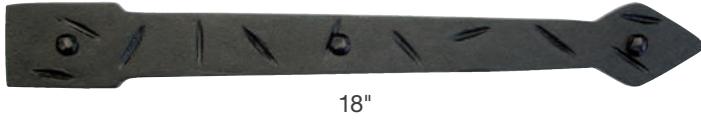

## Dentil Shelves

Complete the look with a dentil shelf for true Craftsman appeal.



Fiber-Classic. 4-Block Dentil Shelf\*



Smooth-Star. 4-Block Dentil Shelf\*



\*Not recommended for use behind storm doors or to be painted dark colors, if exposed to direct sunlight.  
 Note: See your Therma-Tru seller or visit [thermatru.com](http://thermatru.com) for details on product sizes and options, limited warranties, exclusions and Riders.  
 Bottom: Fiber-Classic Mahogany Collection, Clear Glass with SDLs, Door – FCM4816, Clear Glass with Grille Sticks, Transom – 19200T, Finish – Acorn; Dentil Shelf



# EnLiten™ Flush-Glazed Designs

EnLiten flush-glazed designs feature double- or triple-pane glass built directly into the door with a high-performance dual adhesive weather seal. This creates a seamless look with a simple profile around the glass and no lite frame or screw plugs. In addition, EnLiten flush-glazed designs offer up to a 16% increase in visible glass area than conventional lite frames to welcome more natural light into the home.



up to **16%**  
WIDER

**Flush-Glazed Glass**

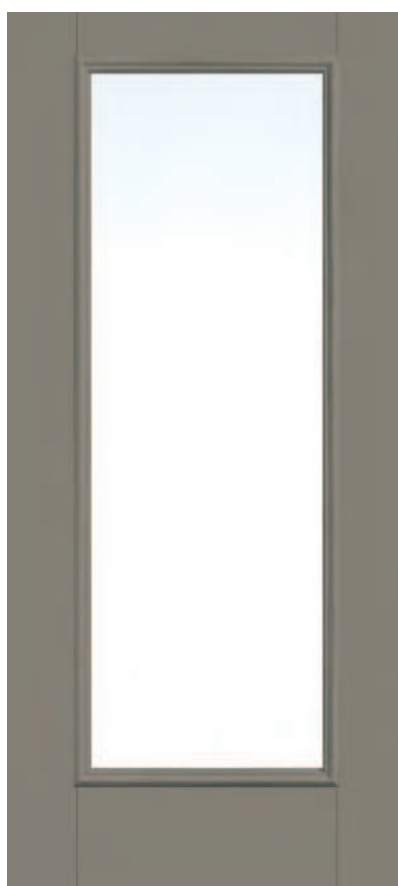

**Lip-Lite Frame**

## SEE THE DIFFERENCE

EnLiten flush-glazed designs provide a simple profile with no added embellishments around the glass.

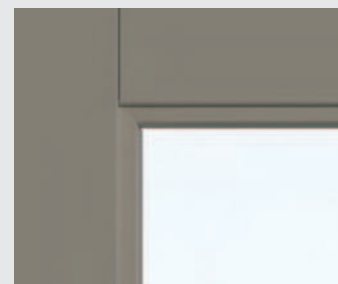

**Flush-Glazed Glass with Detailed Sticking**

Look for the ( 🔴 ) symbol.



**Flush-Glazed Glass with Square Sticking**

Look for the ( 🔵 ) symbol.

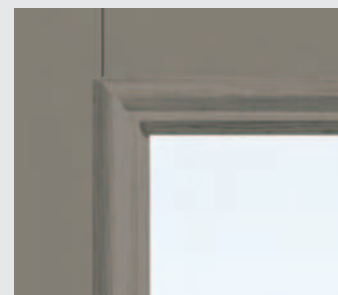

**Lip-Lite Frame**

## WARRANTY RIDERS FOR PEACE OF MIND

### EnLiten™ Flush-Glazed Rider for Construction & Installation

Provides protection in case of accidental glass breakage during residential and multi-family construction or installation. Therma-Tru will replace the flush-glazed fiberglass door or sidelite.

### EnLiten™ Flush-Glazed Rider for Homeowners

Provides protection in case of glass-related failures due to manufacturer defect. Therma-Tru will furnish \$300 toward installation and replace the flush-glazed fiberglass door or sidelite.

# EnLiten™ Flush-Glazed Full Lites



















## TRANSOMS

For transoms, see page 209.

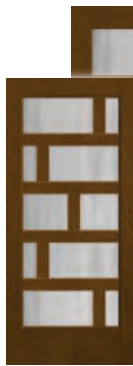

## PRIVACY & TEXTURED GLASS WITH DIVIDED LITES

									
<b>Oak</b>	<b>Oak</b>	<b>Oak</b>	<b>Oak</b>	<b>Oak</b>	<b>Oak</b>	<b>Oak</b>			
FC1205_ 🔥🔥 2'6" x 6'8" 2'8" x 6'8" 3'0" x 6'8"	FC1207_ 🔥🔥 2'6" x 6'8" 2'8" x 6'8" 3'0" x 6'8"	2010_ 🔥🔥 2'6" x 6'8" 2'8" x 6'8" 3'0" x 6'8"	2050_ 🔥🔥 2'6" x 6'8" 2'8" x 6'8" 3'0" x 6'8"	2050_SL 🔥🔥 12" x 6'8" 14" x 6'8"	FC5700_ 🔥🔥 2'6" x 6'8" 2'8" x 6'8" 3'0" x 6'8"	FC85700_ 🔥🔥 2'6" x 8'0" 2'8" x 8'0" 2'10" x 8'0" 3'0" x 8'0"			
									
<b>Oak</b>	<b>Oak</b>	<b>Oak</b>	<b>Oak</b>	<b>Oak</b>	<b>Oak</b>	<b>Oak</b>	<b>Oak</b>	<b>Oak</b>	<b>Oak</b>
FC5710_ 🔥🔥 2'6" x 6'8" 2'8" x 6'8" 3'0" x 6'8"	FC85710_ 🔥🔥 2'6" x 8'0" 2'8" x 8'0" 2'10" x 8'0" 3'0" x 8'0"	FC5720_ 🔥🔥 2'6" x 6'8" 2'8" x 6'8" 3'0" x 6'8"	FC85720_ 🔥🔥 2'6" x 8'0" 2'8" x 8'0" 2'10" x 8'0" 3'0" x 8'0"	FC691_ 🔥🔥 2'6" x 6'8" 2'8" x 6'8" 3'0" x 6'8"	FC8691_ 🔥🔥 2'6" x 8'0" 2'8" x 8'0" 2'10" x 8'0" 3'0" x 8'0"	FC685L_ 🔥🔥 2'6" x 6'8" 2'8" x 6'8" 3'0" x 6'8"	FC8685L_ 🔥🔥 2'6" x 8'0" 2'8" x 8'0" 2'10" x 8'0" 3'0" x 8'0"	FC685R_ 🔥🔥 2'6" x 6'8" 2'8" x 6'8" 3'0" x 6'8"	FC8685R_ 🔥🔥 2'6" x 8'0" 2'8" x 8'0" 2'10" x 8'0" 3'0" x 8'0"

### Privacy & Textured Glass Options

Add the code to the blank in the style number for the desired door and glass combination. For details on glass options, see page 119.

XK = Reeded    XC = Chord    XR = Rainglass  
XE = Satin Etch    XJ = Chinchilla    XN = Granite

\*Not available with Reeded (XK) glass.

Note: See page 285 for important product details that may help with your purchase decision.

Top: Fiber-Classic Oak Collection, Clear Glass with SDLs, Door – FC5700, Sidelite – FC5700SL, Finish – Wildflower Honey



Oak

FC5700\_SL  
▲ 2  
12" x 6'8"  
14" x 6'8"



Oak

FC5710\_SL  
▲ 2  
12" x 6'8"  
14" x 6'8"



Oak

FC5720\_SL  
▲ 2  
12" x 6'8"  
14" x 6'8"



Smooth

S1205  
▲ 2 E 6  
2'6" x 6'8" ▲  
2'8" x 6'8" ▲  
2'10" x 6'8" ▲  
3'0" x 6'8" ▲



Smooth

S1207  
▲ 2 E 6  
2'6" x 6'8" ▲  
2'8" x 6'8" ▲  
2'10" x 6'8" ▲  
3'0" x 6'8" ▲



Smooth

S2010  
▲ 2 E 6  
2'6" x 6'8" ▲  
2'8" x 6'8" ▲  
2'10" x 6'8" ▲  
3'0" x 6'8" ▲



Smooth

S2050  
▲ 2 E 6  
2'6" x 6'8" ▲  
2'8" x 6'8" ▲  
2'10" x 6'8" ▲  
3'0" x 6'8" ▲



Smooth

S5705  
▲ 2 E 6  
2'6" x 6'8" ▲  
2'8" x 6'8" ▲  
2'10" x 6'8" ▲  
3'0" x 6'8" ▲



Smooth

S85705  
▲ 2 E 6  
2'6" x 8'0"  
2'8" x 8'0"  
2'10" x 8'0"  
3'0" x 8'0"



Smooth

S5725  
▲ 2 E 6  
2'6" x 6'8" ▲  
2'8" x 6'8" ▲  
2'10" x 6'8" ▲  
3'0" x 6'8" ▲



NEW

Smooth

S2010\_SL  
▲ 2 E 6  
10" x 6'8" ▲  
12" x 6'8" ▲ (7'0")  
14" x 6'8" ▲ (7'0")



Smooth

S2000\_SL-2C\*  
▲ 2 E 6  
10" x 6'8" ▲  
12" x 6'8" ▲ (7'0")  
14" x 6'8" ▲ (7'0")



Smooth

S2000\_SL-4C\*  
▲ 2 E 6  
10" x 6'8" ▲  
12" x 6'8" ▲  
14" x 6'8" ▲



Smooth

S5700  
▲ 2 E 6  
2'6" x 6'8" ▲  
2'8" x 6'8" ▲  
2'10" x 6'8" ▲  
3'0" x 6'8" ▲



Smooth

S85700  
▲ 2 E 6  
2'6" x 8'0"  
2'8" x 8'0"  
2'10" x 8'0"  
3'0" x 8'0"



Smooth

S5710  
▲ 2 E 6  
2'6" x 6'8" ▲  
2'8" x 6'8" ▲  
2'10" x 6'8" ▲  
3'0" x 6'8" ▲



Smooth

S85710  
▲ 2 E 6  
2'6" x 8'0"  
2'8" x 8'0"  
2'10" x 8'0"  
3'0" x 8'0"

Key





- ▲ Flush-Glazed Glass with Detailed Sticking (FG)
- ▲ Simulated Divided Lites (SDL)
- ▲ Simulated Divided Lites (SDLF1)



- ▲ Simulated Divided Lites (SDLF2)
- ▲ Vented Sidelite Options
- ▲ WBDR Options
- ▲ Elevated 10" Bottom Rail Options

▲ 6'6" Height Available

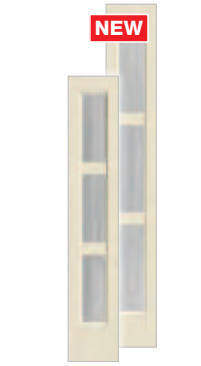
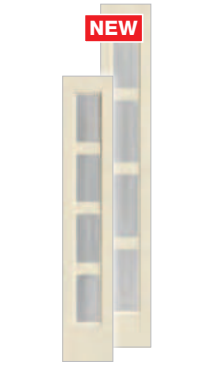
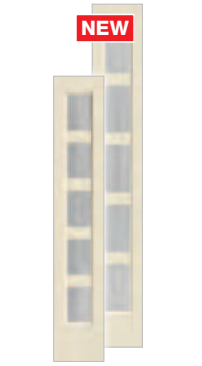

PRIVACY & TEXTURED GLASS WITH DIVIDED LITES *Continues on next page.*

**PRIVACY & TEXTURED GLASS WITH DIVIDED LITES** *Continued*

				
<b>NEW</b>	<b>NEW</b>	<b>NEW</b>		
<b>Smooth</b>	<b>Smooth</b>	<b>Smooth</b>	<b>Smooth</b>	<b>Smooth</b>
<b>S3400</b> ▲ <b>E 6</b> 2'6" x 6'8" 2'8" x 6'8" 2'10" x 6'8" 3'0" x 6'8"	<b>S83400</b> ▲ <b>E 6</b> 2'6" x 8'0" 2'8" x 8'0" 2'10" x 8'0" 3'0" x 8'0"	<b>S3300</b> ▲ <b>E 6</b> 2'6" x 6'8" 2'8" x 6'8" 2'10" x 6'8" 3'0" x 6'8"	<b>S3500</b> ▲ <b>E 6</b> 2'6" x 6'8" 2'8" x 6'8" 2'10" x 6'8" 3'0" x 6'8"	<b>S685L</b> ▲ <b>E 6</b> 2'6" x 6'8" ▲ 2'8" x 6'8" ▲ 2'10" x 6'8" ▲ 3'0" x 6'8" ▲

							
<b>NEW</b>	<b>NEW</b>	<b>NEW</b>	<b>NEW</b>	<b>NEW</b>			
<b>Smooth</b>	<b>Smooth</b>	<b>Smooth</b>	<b>Smooth</b>	<b>Smooth</b>	<b>Smooth</b>	<b>Smooth</b>	<b>Smooth</b>
<b>S3600</b> ▲ <b>E 6</b> 2'6" x 6'8" 2'8" x 6'8" 2'10" x 6'8" 3'0" x 6'8"	<b>S83600</b> ▲ <b>E 6</b> 2'6" x 8'0" 2'8" x 8'0" 2'10" x 8'0" 3'0" x 8'0"	<b>S5700_SL</b> ▲ <b>E</b> 10" x 6'8" ▲ 12" x 6'8" ▲ (7'0") 14" x 6'8" ▲ (7'0")	<b>S85227_SL</b> ▲ <b>E</b> 12" x 8'0" 14" x 8'0"	<b>S5710_SL</b> ▲ <b>E</b> 10" x 6'8" ▲ 12" x 6'8" ▲ (7'0") 14" x 6'8" ▲ (7'0")	<b>S85228_SL</b> ▲ <b>E</b> 12" x 8'0" 14" x 8'0"	<b>S5720_SL</b> ▲ <b>E</b> 10" x 6'8" ▲ 12" x 6'8" ▲ (7'0") 14" x 6'8" ▲ (7'0")	<b>S85229_SL</b> ▲ <b>E</b> 12" x 8'0" 14" x 8'0"

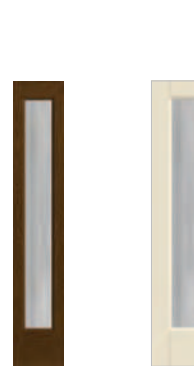
**PRIVACY & TEXTURED GLASS**

						
			<b>NEW</b>			
<b>Oak</b>	<b>Oak</b>	<b>Smooth</b>	<b>Smooth</b>	<b>Smooth</b>	<b>Smooth</b>	<b>Smooth</b>
<b>2000_</b> ▲ <b>E 6</b> 2'6" x 6'8" 2'8" x 6'8" 3'0" x 6'8"	<b>8000_</b> ▲ <b>E 6</b> 2'6" x 8'0" 2'8" x 8'0" 2'10" x 8'0" 3'0" x 8'0"	<b>2000_SL</b> ▲ <b>E 6</b> 12" x 6'8" 14" x 6'8"	<b>S2000_</b> ▲ <b>E 6</b> 2'6" x 6'8" ▲ 2'8" x 6'8" ▲ 2'10" x 6'8" ▲ 3'0" x 6'8" ▲	<b>S8000_</b> ▲ <b>E 6</b> 2'6" x 8'0" 2'8" x 8'0" 2'10" x 8'0" ▲ 3'0" x 8'0"	<b>S2000_SL</b> ▲ <b>E 6</b> 10" x 6'8" ▲ 12" x 6'8" ▲ (7'0") 14" x 6'8" ▲ (7'0")	<b>S85225_SL</b> ▲ <b>E</b> 12" x 8'0" 14" x 8'0"

**INTERNAL BLINDS**

	
<b>Smooth</b>	<b>Smooth</b>
<b>S2600</b> ▲ <b>E</b> 2'6" x 6'8" ▲ 2'8" x 6'8" ▲ 2'10" x 6'8" ▲ 3'0" x 6'8" ▲	<b>S82600</b> ▲ <b>E</b> 2'6" x 8'0" 2'8" x 8'0" 2'10" x 8'0" ▲ 3'0" x 8'0"

**Privacy & Textured Glass Options**

Add the code to the blank in the style number for the desired door and glass combination. For details on glass options, see page 119.

XK = Reeded    XC = Chord    XR = Rainglass  
XE = Satin Etch    XJ = Chinchilla    XN = Granite

CLEAR GLASS WITH DIVIDED LITES



Mahogany

FCM1205SL  
 ☀️ ⚡️ 🔍 🌿  
 12" x 6'8" (7'0")  
 14" x 6'8" (7'0")



Mahogany

FCM1206SL  
 ☀️ ⚡️ 🔍 🌿  
 12" x 6'8" (7'0")  
 14" x 6'8" (7'0")



Mahogany

FCM1204SL  
 ☀️ ⚡️ 🔍 🌿  
 12" x 6'8" (7'0")  
 14" x 6'8" (7'0")



Mahogany

FCM2009SL  
 ☀️ ⚡️ 🔍 🌿  
 12" x 6'8" (7'0")  
 14" x 6'8" (7'0")



Oak

FC1205  
 ☀️ ⚡️ 🔍 🌿  
 2'6" x 6'8"  
 2'8" x 6'8"  
 3'0" x 6'8"



Oak

FC1206  
 ☀️ ⚡️ 🔍 🌿  
 2'6" x 6'8"  
 2'8" x 6'8"  
 3'0" x 6'8"



Oak

FC1207  
 ☀️ ⚡️ 🔍 🌿  
 2'6" x 6'8"  
 2'8" x 6'8"  
 3'0" x 6'8"



Oak

2010  
 ☀️ ⚡️ 🔍 🌿  
 2'6" x 6'8"  
 2'8" x 6'8"  
 3'0" x 6'8"



Oak

FC1204  
 ☀️ ⚡️ 🔍 🌿  
 2'6" x 6'8"  
 2'8" x 6'8"  
 3'0" x 6'8"

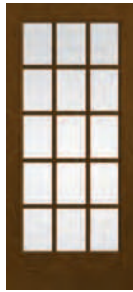

Oak

2050  
 ☀️ ⚡️ 🔍 🌿  
 2'6" x 6'8"  
 2'8" x 6'8"  
 3'0" x 6'8"



Oak

8000-12  
 ☀️ ⚡️ 🔍 🌿  
 2'6" x 8'0"  
 2'8" x 8'0"  
 2'10" x 8'0"  
 3'0" x 8'0"



Oak

8000-18  
 ☀️ ⚡️ 🔍 🌿  
 2'6" x 8'0"  
 2'8" x 8'0"  
 2'10" x 8'0"  
 3'0" x 8'0"



Oak

FC1205SL  
 ☀️ ⚡️ 🔍 🌿  
 12" x 6'8"  
 14" x 6'8"



Oak

FC1206SL  
 ☀️ ⚡️ 🔍 🌿  
 12" x 6'8"  
 14" x 6'8"



Oak

FC1204SL  
 ☀️ ⚡️ 🔍 🌿  
 12" x 6'8"  
 14" x 6'8"



Oak

2050SL  
 ☀️ ⚡️ 🔍 🌿  
 12" x 6'8"  
 14" x 6'8"



Oak

2009  
 ☀️ ⚡️ 🔍 🌿  
 2'0" x 6'8"  
 2'6" x 6'8"  
 2'8" x 6'8"  
 3'0" x 6'8"



Oak

2009SL  
 ☀️ ⚡️ 🔍 🌿  
 12" x 6'8"  
 14" x 6'8"



Oak

FC5700  
 ☀️ ⚡️ 🔍 🌿  
 2'6" x 6'8"  
 2'8" x 6'8"  
 3'0" x 6'8"



Oak

FC85700  
 ☀️ ⚡️ 🔍 🌿  
 2'6" x 8'0"  
 2'8" x 8'0"  
 3'0" x 6'8"

8000-9  
 ☀️ ⚡️ 🔍 🌿  
 2'0" x 8'0"  
 2'6" x 8'0"  
 2'8" x 8'0"  
 2'10" x 8'0"  
 3'0" x 8'0"

FC85700  
 ☀️ ⚡️ 🔍 🌿  
 2'6" x 8'0"  
 2'8" x 8'0"  
 2'10" x 8'0"  
 3'0" x 8'0"

FC85710  
 ☀️ ⚡️ 🔍 🌿  
 2'6" x 8'0"  
 2'8" x 8'0"  
 2'10" x 8'0"  
 3'0" x 8'0"

CLEAR GLASS WITH DIVIDED LITES *Continues on next page.*

Key

- ☀️ Flush-Glazed Glass with Detailed Sticking (FG)
- ⚡️ Flush-Glazed Glass with Square Sticking (FG)
- 🌿 Low-E Glass (LE)
- 🏠 Simulated Divided Lites (SDL)
- 🏠 Simulated Divided Lites (SDLF1)
- 🏠 Simulated Divided Lites (SDLF2)
- 🔍 Flat or Contour White Grilles Between Glass (GBGF / GBGC)
- 🔍 Flat Almond Grilles Between Glass (GBGF)
- 🌿 Flat Bronze Grilles Between Glass (GBGF)
- 🌿 Vented Sidelite Options
- 🔄 WBDR Options
- 📏 Elevated 10" Bottom Rail Options
- ⚡️ 6'6" Height Available

**CLEAR GLASS WITH DIVIDED LITES** *Continued*



Oak

**FC5720**  
 ▲ 🔥 ⚡ 2  
 2'6" x 6'8"  
 2'8" x 6'8"  
 3'0" x 6'8"

**FC85720**  
 ▲ 🔥 ⚡ 2  
 2'6" x 8'0"  
 2'8" x 8'0"  
 2'10" x 8'0"  
 3'0" x 8'0"



Oak

**FC691**  
 ▲ 🔥 ⚡ 2  
 2'6" x 6'8"  
 2'8" x 6'8"  
 3'0" x 6'8"

**FC8691**  
 ▲ 🔥 ⚡ 2  
 2'6" x 8'0"  
 2'8" x 8'0"  
 2'10" x 8'0"  
 3'0" x 8'0"

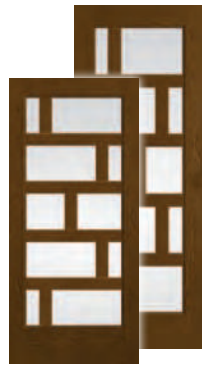

Oak

**FC685L**  
 ▲ 🔥 ⚡ 2  
 2'6" x 6'8"  
 2'8" x 6'8"  
 3'0" x 6'8"

**FC8685L**  
 ▲ 🔥 ⚡ 2  
 2'6" x 8'0"  
 2'8" x 8'0"  
 2'10" x 8'0"  
 3'0" x 8'0"



Oak

**FC685R**  
 ▲ 🔥 ⚡ 2  
 2'6" x 6'8"  
 2'8" x 6'8"  
 3'0" x 6'8"

**FC8685R**  
 ▲ 🔥 ⚡ 2  
 2'6" x 8'0"  
 2'8" x 8'0"  
 2'10" x 8'0"  
 3'0" x 8'0"



Oak

**FC5700SL**  
 ▲ 🔥 ⚡ 2  
 12" x 6'8"  
 14" x 6'8"



Oak

**FC5710SL**  
 ▲ 🔥 ⚡ 2  
 12" x 6'8"  
 14" x 6'8"



Oak

**FC5720SL**  
 ▲ 🔥 ⚡ 2  
 12" x 6'8"  
 14" x 6'8"



Smooth

**S1205**  
 ▲ 🔥 ⚡ ⚡ 1 ⚡ ⚡ ⚡  
 ⚡ E ⚡  
 2'6" x 6'8" ⚡  
 2'8" x 6'8" ⚡  
 2'10" x 6'8" ⚡  
 3'0" x 6'8" ⚡



Smooth

**S1206**  
 ▲ 🔥 ⚡ ⚡ ⚡ ⚡ E  
 2'6" x 6'8" ⚡  
 2'8" x 6'8" ⚡  
 2'10" x 6'8" ⚡  
 3'0" x 6'8" ⚡



Smooth

**S1207**  
 ▲ 🔥 ⚡ ⚡ ⚡ ⚡  
 E ⚡  
 2'6" x 6'8" ⚡  
 2'8" x 6'8" ⚡  
 2'10" x 6'8" ⚡  
 3'0" x 6'8" ⚡



Smooth

**S2010**  
 ▲ 🔥 ⚡ ⚡ ⚡ ⚡  
 E ⚡  
 2'6" x 6'8" ⚡  
 2'8" x 6'8" ⚡  
 2'10" x 6'8" ⚡  
 3'0" x 6'8" ⚡



Smooth

**S1204**  
 ▲ 🔥 ⚡ ⚡ ⚡ ⚡ E  
 2'6" x 6'8" ⚡  
 2'8" x 6'8" ⚡  
 2'10" x 6'8" ⚡  
 3'0" x 6'8" ⚡



Smooth

**S2050**  
 ▲ 🔥 ⚡ ⚡ ⚡ ⚡  
 E ⚡  
 2'6" x 6'8" ⚡  
 2'8" x 6'8" ⚡  
 2'10" x 6'8" ⚡  
 3'0" x 6'8" ⚡



Smooth

**S8000-12**  
 ▲ 🔥 ⚡ ⚡ ⚡ ⚡ E  
 2'6" x 8'0"  
 2'8" x 8'0"  
 2'10" x 8'0"  
 3'0" x 8'0"



Smooth

**S8000-18**  
 ▲ 🔥 ⚡ ⚡ ⚡ ⚡ E  
 2'6" x 8'0"  
 2'8" x 8'0"  
 2'10" x 8'0"  
 3'0" x 8'0"



Smooth

**S5705**  
 ▲ 🔥 ⚡ ⚡ E ⚡  
 2'6" x 6'8" ⚡  
 2'8" x 6'8" ⚡  
 2'10" x 6'8" ⚡  
 3'0" x 6'8" ⚡

**S85705**  
 ▲ 🔥 ⚡ ⚡ E ⚡  
 2'6" x 8'0"  
 2'8" x 8'0"  
 2'10" x 8'0"  
 3'0" x 8'0"



Smooth

**S5715**  
 ▲ 🔥 ⚡ ⚡ E ⚡  
 2'6" x 6'8" ⚡  
 2'8" x 6'8" ⚡  
 2'10" x 6'8" ⚡  
 3'0" x 6'8" ⚡

**S85715**  
 ▲ 🔥 ⚡ ⚡ E ⚡  
 2'6" x 8'0"  
 2'8" x 8'0"  
 2'10" x 8'0"  
 3'0" x 8'0"





**Smooth**

S5725  
 ▲ ★ ✨ E 6  
 2'6" x 6'8" ▲  
 2'8" x 6'8" ▲  
 2'10" x 6'8" ▲  
 3'0" x 6'8" ▲



**Smooth**

S85725  
 ▲ ★ ✨ E 6  
 2'6" x 8'0" ▲  
 2'8" x 8'0" ▲  
 2'10" x 8'0" ▲  
 3'0" x 8'0" ▲



**Smooth**

S1205SL  
 ▲ ★ ✨ ⬆ ⬇ ⬅  
 10" x 6'8" ▲  
 12" x 6'8" ▲ (7'0")  
 14" x 6'8" ▲ (7'0")



**Smooth**

S1206SL  
 ▲ ★ ✨ ⬆ ⬇ ⬅  
 10" x 6'8" ▲  
 12" x 6'8" ▲ (7'0")  
 14" x 6'8" ▲ (7'0")



**Smooth**

S1204SL  
 ▲ ★ ✨ ⬆ ⬇ ⬅  
 10" x 6'8" ▲  
 12" x 6'8" ▲ (7'0")  
 14" x 6'8" ▲ (7'0")

NEW



**Smooth**

S2010SL  
 ▲ ★ ✨ ⬆ ⬇ ⬅  
 10" x 6'8" ▲  
 12" x 6'8" ▲ (7'0")  
 14" x 6'8" ▲ (7'0")



**Smooth**

S85226SL  
 ▲ ★ ✨ E  
 12" x 8'0" ▲  
 14" x 8'0" ▲



**Smooth**

S2000SL-2C  
 ▲ ★ ✨  
 10" x 6'8" ▲  
 12" x 6'8" ▲ (7'0")  
 14" x 6'8" ▲ (7'0")

**Smooth**

S2000SL-4C  
 ▲ ★ ✨  
 10" x 6'8" ▲  
 12" x 6'8" ▲ (7'0")  
 14" x 6'8" ▲ (7'0")



**Smooth**

S2009  
 ▲ ★ ✨ ⬆ ⬇ ⬅ E  
 2'0" x 6'8" ▲  
 2'6" x 6'8" ▲  
 2'8" x 6'8" ▲  
 2'10" x 6'8" ▲  
 3'0" x 6'8" ▲

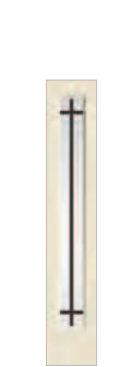

**Smooth**

S8000-9  
 ▲ ★ ✨ ⬆ ⬇ ⬅ E  
 2'0" x 8'0" ▲  
 2'6" x 8'0" ▲  
 2'8" x 8'0" ▲  
 2'10" x 8'0" ▲  
 3'0" x 8'0" ▲



**Smooth**

S2009SL  
 ▲ ★ ✨ ⬆ ⬇ ⬅  
 10" x 6'8" ▲  
 12" x 6'8" ▲ (7'0")  
 14" x 6'8" ▲ (7'0")



**Smooth**

S5700  
 ▲ ★ ✨ E 6  
 2'6" x 6'8" ▲  
 2'8" x 6'8" ▲  
 2'10" x 6'8" ▲  
 3'0" x 6'8" ▲



**Smooth**

S85700  
 ▲ ★ ✨ E 6  
 2'6" x 8'0" ▲  
 2'8" x 8'0" ▲  
 2'10" x 8'0" ▲  
 3'0" x 8'0" ▲



**Smooth**

S5710  
 ▲ ★ ✨ E 6  
 2'6" x 6'8" ▲  
 2'8" x 6'8" ▲  
 2'10" x 6'8" ▲  
 3'0" x 6'8" ▲



**Smooth**

S85710  
 ▲ ★ ✨ E 6  
 2'6" x 8'0" ▲  
 2'8" x 8'0" ▲  
 2'10" x 8'0" ▲  
 3'0" x 8'0" ▲

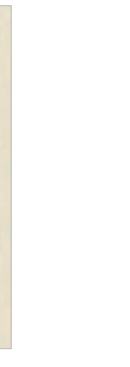

**Smooth**

S5720  
 ▲ ★ ✨ E 6  
 2'6" x 6'8" ▲  
 2'8" x 6'8" ▲  
 2'10" x 6'8" ▲  
 3'0" x 6'8" ▲

**Smooth**

S85720  
 ▲ ★ ✨ E 6  
 2'6" x 8'0" ▲  
 2'8" x 8'0" ▲  
 2'10" x 8'0" ▲  
 3'0" x 8'0" ▲



**Smooth**

S691  
 ▲ ★ ✨ E 6  
 2'6" x 6'8" ▲  
 2'8" x 6'8" ▲  
 2'10" x 6'8" ▲  
 3'0" x 6'8" ▲



**Smooth**

S8691  
 ▲ ★ ✨ E 6  
 2'6" x 8'0" ▲  
 2'8" x 8'0" ▲  
 2'10" x 8'0" ▲  
 3'0" x 8'0" ▲



**Smooth**

S3400  
 ▲ ★ ✨ E 6  
 2'6" x 6'8" ▲  
 2'8" x 6'8" ▲  
 2'10" x 6'8" ▲  
 3'0" x 6'8" ▲



**Smooth**

S83400  
 ▲ ★ ✨ E 6  
 2'6" x 8'0" ▲  
 2'8" x 8'0" ▲  
 2'10" x 8'0" ▲  
 3'0" x 8'0" ▲



**Smooth**

S3300  
 ▲ ★ ✨ E 6  
 2'6" x 6'8" ▲  
 2'8" x 6'8" ▲  
 2'10" x 6'8" ▲  
 3'0" x 6'8" ▲



**Smooth**

S83300  
 ▲ ★ ✨ E 6  
 2'6" x 8'0" ▲  
 2'8" x 8'0" ▲  
 2'10" x 8'0" ▲  
 3'0" x 8'0" ▲



**Smooth**

S3500  
 ▲ ★ ✨ E 6  
 2'6" x 6'8" ▲  
 2'8" x 6'8" ▲  
 2'10" x 6'8" ▲  
 3'0" x 6'8" ▲



**Smooth**

S83500  
 ▲ ★ ✨ E 6  
 2'6" x 8'0" ▲  
 2'8" x 8'0" ▲  
 2'10" x 8'0" ▲  
 3'0" x 8'0" ▲



**Smooth**

S685L  
 ▲ ★ ✨ E 6  
 2'6" x 6'8" ▲  
 2'8" x 6'8" ▲  
 2'10" x 6'8" ▲  
 3'0" x 6'8" ▲



**Smooth**

S8685L  
 ▲ ★ ✨ E 6  
 2'6" x 8'0" ▲  
 2'8" x 8'0" ▲  
 2'10" x 8'0" ▲  
 3'0" x 8'0" ▲

NEW

NEW

NEW

NEW

NEW

NEW

CLEAR GLASS WITH DIVIDED LITES *Continues on next page.*

Key

- ▲ Flush-Glazed Glass with Detailed Sticking (FG)
- ★ Low-E Glass (LE)
- ✨ Simulated Divided Lites (SDL)
- 🔲 Simulated Divided Lites (SDLF)
- 🔲 Simulated Divided Lites (SDLF2)
- ⬆ Flat or Contour White Grilles Between Glass (GBGF / GBGC)
- ⬇ Flat or Contour Black Grilles Between Glass (GBGF / GBGC)
- ⬅ Flat Almond Grilles Between Glass (GBGF)
- ⬆ Flat Bronze Grilles Between Glass (GBGF)
- ⬇ Flat or Contour Black Grilles Between Glass (GBGF / GBGC)
- Vented Sidelite Options
- 🔲 WBDRO Options
- E Elevated 10" Bottom Rail Options
- ▲ 6'6" Height Available

**CLEAR GLASS WITH DIVIDED LITES** *Continued*



Smooth

S685R

- ▲ ★ 2 E 6
- 2'6" x 6'8" ▲
- 2'8" x 6'8" ▲
- 2'10" x 6'8" ▲
- 3'0" x 6'8" ▲

S8685R

- ▲ ★ 2 E 6
- 2'6" x 8'0" ▲
- 2'8" x 8'0" ▲
- 2'10" x 8'0" ▲
- 3'0" x 8'0" ▲



NEW

NEW

Smooth

S3600

- ▲ ★ 2 E 6
- 2'6" x 6'8" ▲
- 2'8" x 6'8" ▲
- 2'10" x 6'8" ▲
- 3'0" x 6'8" ▲

S83600

- ▲ ★ 2 E 6
- 2'6" x 8'0" ▲
- 2'8" x 8'0" ▲
- 2'10" x 8'0" ▲
- 3'0" x 8'0" ▲



NEW

Smooth

S5700SL

- ▲ ★ 2 ●
- 10" x 6'8" ▲
- 12" x 6'8" ▲ (7'0")
- 14" x 6'8" ▲ (7'0")

S85227SL

- ▲ ★ 2 E
- 12" x 8'0" ▲
- 14" x 8'0" ▲



NEW

Smooth

S5710SL

- ▲ ★ 2 ●
- 10" x 6'8" ▲
- 12" x 6'8" ▲ (7'0")
- 14" x 6'8" ▲ (7'0")

S85228SL

- ▲ ★ 2 E
- 12" x 8'0" ▲
- 14" x 8'0" ▲



NEW

Smooth

S5720SL

- ▲ ★ 2 ●
- 10" x 6'8" ▲
- 12" x 6'8" ▲ (7'0")
- 14" x 6'8" ▲ (7'0")

S85229SL

- ▲ ★ 2 E
- 12" x 8'0" ▲
- 14" x 8'0" ▲

**CLEAR GLASS**



Oak

2000

- ▲ ★
- 2'0" x 6'8" ▲
- 2'6" x 6'8" ▲
- 2'8" x 6'8" ▲
- 3'0" x 6'8" ▲

8000

- ▲ ★
- 2'0" x 8'0" ▲
- 2'6" x 8'0" ▲
- 2'8" x 8'0" ▲
- 2'10" x 8'0" ▲
- 3'0" x 8'0" ▲



Oak

2000SL

- ▲ ★
- 12" x 6'8" ▲
- 14" x 6'8" ▲



Smooth

S2000

- ▲ ★ E 6
- 2'0" x 6'8" ▲
- 2'6" x 6'8" ▲
- 2'8" x 6'8" ▲
- 2'10" x 6'8" ▲
- 3'0" x 6'8" ▲

S8000

- ▲ ★ E 6
- 2'0" x 8'0" ▲
- 2'6" x 8'0" ▲
- 2'8" x 8'0" ▲
- 2'10" x 8'0" ▲
- 3'0" x 8'0" ▲



NEW

Smooth

S2000SL

- ▲ ★ ●
- 10" x 6'8" ▲
- 12" x 6'8" ▲ (7'0")
- 14" x 6'8" ▲ (7'0")

S85225SL

- ▲ ★ E
- 12" x 8'0" ▲
- 14" x 8'0" ▲

**Privacy & Textured Glass Options**

Add the code to the blank in the style number for the desired door and glass combination. For details on glass options, see page 119.

XK = Reeded

XC = Chord

XR = Rainglass

XE = Satin Etch

XJ = Chinchilla

XN = Granite

Note: See page 285 for important product details that may help with your purchase decision.

# EnLiten™ Flush-Glazed 3/4 Lites



## TRANSOMS

For transoms, see page 209.

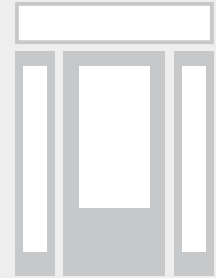

## PRIVACY & TEXTURED GLASS WITH DIVIDED LITES

<b>Smooth</b>	<b>Smooth</b>	<b>Smooth</b>	<b>Smooth</b>	<b>Smooth</b>	<b>Smooth</b>	<b>Smooth</b>	<b>Smooth</b>
S2103_	S82103_	S2104_	S82105_	S82106_	S2250_	S82107_	S84886_SL
▲▲	▲▲▲	▲▲▲	▲▲	▲▲	▲▲▲	▲▲	▲▲
2'6" x 6'8"	2'6" x 8'0"	2'6" x 6'8"	2'6" x 8'0"	2'6" x 8'0"	2'6" x 6'8"	2'6" x 8'0"	12" x 8'0"
2'8" x 6'8"	2'8" x 8'0"	2'8" x 6'8"	2'8" x 8'0"	2'8" x 8'0"	2'8" x 6'8"	2'8" x 8'0"	14" x 8'0"
2'10" x 6'8"	2'10" x 8'0"	2'10" x 6'8"	2'10" x 8'0"	2'10" x 8'0"	2'10" x 6'8"	2'10" x 8'0"	
3'0" x 6'8"	3'0" x 8'0"	3'0" x 6'8"	3'0" x 8'0"	3'0" x 8'0"	3'0" x 6'8"	3'0" x 8'0"	

## PRIVACY & TEXTURED GLASS

<b>Smooth</b>	<b>Smooth</b>	<b>Smooth</b>	<b>Smooth</b>	<b>Smooth</b>	<b>Smooth</b>	<b>Smooth</b>
S2103_SL	S2104_SL	S2250_SL	S2200_	S82200_	S8000_SL	S2200_SL
▲▲	▲▲	▲▲	▲	▲	▲	▲
12" x 6'8"	12" x 6'8"	12" x 6'8"	2'6" x 6'8"	2'6" x 8'0"	12" x 8'0"	12" x 6'8"
14" x 6'8"	14" x 6'8"	14" x 6'8"	2'8" x 6'8"	2'8" x 8'0"	14" x 8'0"	14" x 6'8"
			2'10" x 6'8"	2'10" x 8'0"		
			3'0" x 6'8"	3'0" x 8'0"		

### Key

- ▲ Flush-Glazed Glass with Detailed Sticking (FG)
- ▲▲ Simulated Divided Lites (SDL)
- ▲▲▲ Simulated Divided Lites (SDLF1)
- ▲ Simulated Divided Lites (SDLF2)
- ▲▲ 6'6" Height Available
- Vented Sidelite Options
- Ⓢ WBDR Options
- ⓔ Elevated 10" Bottom Rail Options
- ★ Low-E Glass (LE)



# EnLiten™ Flush-Glazed 1/2 Lites



## TRANSOMS

For transoms, see page 209.

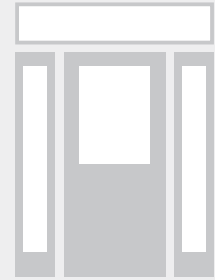

Fiber-Classic® & Smooth-Star®

## PRIVACY & TEXTURED GLASS WITH DIVIDED LITES

<b>Smooth</b>	<b>Smooth</b>	<b>Smooth</b>	<b>Smooth</b>	<b>Smooth</b>	<b>Smooth</b>	<b>Smooth</b>	<b>Smooth</b>	<b>Smooth</b>	<b>Smooth</b>
S4200_ 2'8" x 6'8" (7'0") 2'10" x 6'8" (7'0") 3'0" x 6'8" (7'0")	S84200_ 2'8" x 8'0" 2'10" x 8'0" 3'0" x 8'0"	S6200_ 2'8" x 6'8" (7'0") 2'10" x 6'8" (7'0") 3'0" x 6'8" (7'0")	S86200_ 2'8" x 8'0" 2'10" x 8'0" 3'0" x 8'0"	S9200_ 2'8" x 6'8" (7'0") 2'10" x 6'8" (7'0") 3'0" x 6'8" (7'0")	S89200_ 2'8" x 8'0" 2'10" x 8'0" 3'0" x 8'0"	S4200_SL 12" x 6'8" (7'0") 14" x 6'8" (7'0")	S84200_SL 12" x 8'0" 14" x 8'0"	S6200_SL 12" x 6'8" (7'0") 14" x 6'8" (7'0")	S86200_SL 12" x 8'0" 14" x 8'0"

## PRIVACY & TEXTURED GLASS

<b>Smooth</b>	<b>Smooth</b>	<b>Smooth</b>	<b>Smooth</b>
S3200_ 2'8" x 6'8" (7'0") 2'10" x 6'8" (7'0") 3'0" x 6'8" (7'0")	S83200_ 2'8" x 8'0" 2'10" x 8'0" 3'0" x 8'0"	S3200_SL 12" x 6'8" (7'0") 14" x 6'8" (7'0")	S83200_SL 12" x 8'0" 14" x 8'0"

## CLEAR GLASS WITH DIVIDED LITES

<b>Smooth</b>	<b>Smooth</b>	<b>Smooth</b>
S1350 2'6" x 6'8" 2'8" x 6'8" 3'0" x 6'8"	S2150 2'6" x 6'8" 2'8" x 6'8" 3'0" x 6'8"	S1409 2'6" x 6'8" 2'8" x 6'8" 3'0" x 6'8"

CLEAR GLASS WITH DIVIDED LITES *Continues on next page.*

### Key

- Flush-Glazed Glass with Detailed Sticking (FG)
- Flush-Glazed Glass with Square Sticking (FG)
- Low-E Glass (LE)
- Simulated Divided Lites (SDL)
- Simulated Divided Lites (SDLF1)
- Flat or Contour White Grilles Between Glass (GBGF / GBGC)
- Flat Bronze Grilles Between Glass (GBGF / GBGC)
- Flat Almond Grilles Between Glass (GBGF)
- Flat or Contour Black Grilles Between Glass (GBGF / GBGC)
- Elevated 10" Bottom Rail Options

**CLEAR GLASS WITH DIVIDED LITES** *Continued*



**S4200**  
 ☀️ ⚡️ 🔥 E  
 2'8" x 6'8" (7'0")  
 2'10" x 6'8" (7'0")  
 3'0" x 6'8" (7'0")



**S84200**  
 ⚡️ ⚡️ ⚡️ E  
 2'8" x 8'0"  
 2'10" x 8'0"  
 3'0" x 8'0"

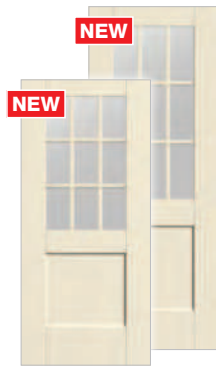

**S9200**  
 ☀️ ⚡️ 🔥 E  
 2'8" x 6'8" (7'0")  
 2'10" x 6'8" (7'0")  
 3'0" x 6'8" (7'0")



**S4200SL**  
 ☀️ ⚡️ 🔥 E  
 12" x 6'8" (7'0")  
 14" x 6'8" (7'0")



**S84200SL**  
 ⚡️ ⚡️ ⚡️ E  
 12" x 8'0"  
 14" x 8'0"

**CLEAR GLASS**



**S2100**  
 ⚡️ ☀️  
 2'6" x 6'8"  
 2'8" x 6'8"  
 3'0" x 6'8"



**S3200**  
 ⚡️ ⚡️ E  
 2'8" x 6'8" (7'0")  
 2'10" x 6'8" (7'0")  
 3'0" x 6'8" (7'0")



**S83200**  
 ⚡️ ⚡️ E  
 2'8" x 8'0"  
 2'10" x 8'0"  
 3'0" x 8'0"

**S3200SL**  
 ⚡️ ⚡️ E  
 12" x 6'8" (7'0")  
 14" x 6'8" (7'0")

**S83200SL**  
 ⚡️ ⚡️ E  
 12" x 8'0"  
 14" x 8'0"



**Privacy & Textured Glass Options**

Add the code to the blank in the style number for the desired door and glass combination. For details on glass options, see page 119.

**XK = Reeded**    **XC = Chord**    **XR = Rainglass**  
**XE = Satin Etch**    **XJ = Chinchilla**    **XN = Granite**

\*Not available with Reeded (XK) glass.

\*\*Not recommended for use behind storm doors or to be painted dark colors, if exposed to direct sunlight.

Note: See page 285 for important product details that may help with your purchase decision.

Bottom: Smooth-Star, Low-E Glass with SDLs, Door - S4200, Sidelite - S3200SL, Finish - Canyon

Right Page: Fiber-Classic Mahogany Collection, Saratoga Glass, Door - FCM6240, Sidelites - FCM6201SL, Transom - 19750T, Finish - Sweet Date

# EnLiten™ Flush-Glazed Craftsman Lites



## TRANSOMS

For transoms, see page 209.

## OPTIONAL DENTIL SHELVES\*\*



**4-Block Dentil Shelf**  
Available for all Craftsman-lite Fiber-Classic Mahogany Collection doors.



**4-Block Dentil Shelf**  
Available for all Craftsman-lite Smooth-Star doors.

## SARATOGA™

<b>Mahogany</b>		<b>Mahogany</b>		<b>Mahogany</b>		<b>Smooth</b>		<b>Smooth</b>		<b>Smooth</b>	
FCM6240 ▲ E 2'8" x 6'8" (7'0") 2'10" x 6'8" (7'0") 3'0" x 6'8" (7'0")	FCM86240 ▲ 2'8" x 8'0" 2'10" x 8'0"	FCM6201SL ▲ 12" x 6'8" (7'0") 14" x 6'8" (7'0")	FCM86201SL ▲ 12" x 8'0" 14" x 8'0"	FCM6240SL ▲ 12" x 6'8" (7'0") 14" x 6'8" (7'0")	FCM86240SL ▲ 12" x 8'0" 14" x 8'0"	S6240 ▲ E 2'8" x 6'8" (7'0") 2'10" x 6'8" (7'0") 3'0" x 6'8" (7'0")	S86240 ▲ 2'8" x 8'0" 2'10" x 8'0" 3'0" x 8'0"	S6201SL ▲ 10" x 6'8" 12" x 6'8" (7'0") 14" x 6'8" (7'0")	S86201SL ▲ 12" x 8'0" 14" x 8'0"	S6240SL ▲ 12" x 6'8" (7'0") 14" x 6'8" (7'0")	S86240SL ▲ 12" x 8'0" 14" x 8'0"

## PRIVACY & TEXTURED GLASS WITH DIVIDED LITES

<b>Mahogany</b>		<b>Mahogany</b>		<b>Mahogany</b>		<b>Mahogany</b>		<b>Mahogany</b>	
FCM4812_* ▲ E 2'8" x 6'8" (7'0") 2'10" x 6'8" (7'0") 3'0" x 6'8" (7'0")	FCM84812_* ▲ 2'8" x 8'0" 2'10" x 8'0"	FCM4813_* ▲ E 2'8" x 6'8" (7'0") 2'10" x 6'8" (7'0") 3'0" x 6'8" (7'0")	FCM84813_* ▲ 2'8" x 8'0" 2'10" x 8'0" 3'0" x 8'0"	FCM4814_* ▲ E 2'8" x 6'8" (7'0") 2'10" x 6'8" (7'0") 3'0" x 6'8" (7'0")	FCM84814_* ▲ 2'8" x 8'0" 2'10" x 8'0" 3'0" x 8'0"	FCM4816_* ▲ E 2'8" x 6'8" (7'0") 2'10" x 6'8" (7'0") 3'0" x 6'8" (7'0")	FCM84816_* ▲ 2'8" x 8'0" 2'10" x 8'0" 3'0" x 8'0"	FCM2050_SL ▲ 12" x 6'8" (7'0") 14" x 6'8" (7'0")	FCM84886_SL ▲ 12" x 8'0" 14" x 8'0"

PRIVACY & TEXTURED GLASS WITH DIVIDED LITES *Continues on next page.*

**Key**

▲ Flush-Glazed Glass with Detailed Sticking (FG)	◆ Black Nickel Caming (1D)	◆ Flat or Contour White Grilles Between Glass (GBGF / GBGC)	◆ Flat or Contour Black Grilles Between Glass (GBGF / GBGC)
▲ Flush-Glazed Glass with Square Sticking (FG)	■ Brushed Nickel Caming (1C)	◆ Flat Almond Grilles Between Glass (GBGF)	● Vented Sidelite Options
★ Low-E Glass (LE)	■ Simulated Divided Lites (SDL)	◆ Flat Bronze Grilles Between Glass (GBGF)	E Elevated 10" Bottom Rail Options
	■ Simulated Divided Lites (SDLF1)		

**PRIVACY & TEXTURED GLASS WITH DIVIDED LITES** *Continued*



**Mahogany**

FCM4812\_SL\*  
 ▲ E  
 12" x 6'8" (7'0")  
 14" x 6'8" (7'0")

FCM84812\_SL\*  
 ▲ E  
 12" x 8'0"  
 14" x 8'0"



**Smooth**

S4812\_\*  
 ▲ E  
 2'8" x 6'8" (7'0")  
 2'10" x 6'8" (7'0")  
 3'0" x 6'8" (7'0")

S84812\_\*  
 ▲ E  
 2'8" x 8'0"  
 2'10" x 8'0"  
 3'0" x 8'0"



**Smooth**

S4813\_\*  
 ▲ E  
 2'8" x 6'8" (7'0")  
 2'10" x 6'8" (7'0")  
 3'0" x 6'8" (7'0")

S84813\_\*  
 ▲ E  
 2'8" x 8'0"  
 2'10" x 8'0"  
 3'0" x 8'0"



**Smooth**

S4814\_\*  
 ▲ E  
 2'8" x 6'8" (7'0")  
 2'10" x 6'8" (7'0")  
 3'0" x 6'8" (7'0")

S84814\_\*  
 ▲ E  
 2'8" x 8'0"  
 2'10" x 8'0"  
 3'0" x 8'0"



**Smooth**

S4816\_\*  
 ▲ E  
 2'8" x 6'8" (7'0")  
 2'10" x 6'8" (7'0")  
 3'0" x 6'8" (7'0")

S84816\_\*  
 ▲ E  
 2'8" x 8'0"  
 2'10" x 8'0"  
 3'0" x 8'0"

**PRIVACY & TEXTURED GLASS**



**Smooth**

S2010\_SL  
 ▲ E  
 10" x 6'8" Δ  
 12" x 6'8" Δ (7'0")  
 14" x 6'8" Δ (7'0")

S84886\_SL  
 ▲ E  
 12" x 8'0"  
 14" x 8'0"



**Smooth**

S4812\_SL\*  
 ▲ E  
 12" x 6'8" (7'0")  
 14" x 6'8" (7'0")

S84812\_SL\*  
 ▲ E  
 12" x 8'0"  
 14" x 8'0"



**Mahogany**

FCM4810\_\*  
 ▲ E  
 2'8" x 6'8" (7'0")  
 2'10" x 6'8" (7'0")  
 3'0" x 6'8" (7'0")

FCM84810\_\*  
 ▲ E  
 2'8" x 8'0"  
 2'10" x 8'0"  
 3'0" x 8'0"



**Mahogany**

FCM2000\_SL  
 ▲ E  
 12" x 6'8" (7'0")  
 14" x 6'8" (7'0")

FCM8000\_SL  
 ▲ E  
 12" x 8'0"  
 14" x 8'0"



**Mahogany**

FCM4810\_SL\*  
 ▲ E  
 12" x 6'8" (7'0")  
 14" x 6'8" (7'0")

FCM84810\_SL\*  
 ▲ E  
 12" x 8'0"  
 14" x 8'0"



**Smooth**

S4810\_\*  
 ▲ E  
 2'8" x 6'8" (7'0")  
 2'10" x 6'8" (7'0")  
 3'0" x 6'8" (7'0")

S84810\_\*  
 ▲ E  
 2'8" x 8'0"  
 2'10" x 8'0"  
 3'0" x 8'0"



**Smooth**

S2000\_SL  
 ▲ E  
 10" x 6'8" Δ  
 12" x 6'8" Δ (7'0")  
 14" x 6'8" Δ (7'0")

S8000\_SL  
 ▲ E  
 12" x 8'0"  
 14" x 8'0"



**Smooth**

S4810\_SL\*  
 ▲ E  
 12" x 6'8" (7'0")  
 14" x 6'8" (7'0")

S84810\_SL\*  
 ▲ E  
 12" x 8'0"  
 14" x 8'0"



**Mahogany**

FCM4812  
 ▲ E  
 2'8" x 6'8" (7'0")  
 2'10" x 6'8" (7'0")  
 3'0" x 6'8" (7'0")

FCM84812  
 ▲ E  
 2'8" x 8'0"  
 2'10" x 8'0"  
 3'0" x 8'0"



**Mahogany**

FCM4813  
 ▲ E  
 2'8" x 6'8" (7'0")  
 2'10" x 6'8" (7'0")  
 3'0" x 6'8" (7'0")

FCM84813  
 ▲ E  
 2'8" x 8'0"  
 2'10" x 8'0"  
 3'0" x 8'0"

**Privacy & Textured Glass Options**

Add the code to the blank in the style number for the desired door and glass combination. For details on glass options, see page 119.

XK = Reeded  
 XE = Satin Etch

XC = Chord  
 XJ = Chinchilla

XR = Rainglass  
 XN = Granite

\*Not available with Reeded (XK) glass.

Note: See page 285 for important product details that may help with your purchase decision.





Mahogany

FCM4814  
 ▲ ★ R E  
 2'8" x 6'8" (7'0")  
 2'10" x 6'8" (7'0")  
 3'0" x 6'8" (7'0")

FCM84814  
 ▲ ★ R  
 2'8" x 8'0"  
 2'10" x 8'0"  
 3'0" x 8'0"



Mahogany

FCM4816  
 ▲ ★ R E  
 2'8" x 6'8" (7'0")  
 2'10" x 6'8" (7'0")  
 3'0" x 6'8" (7'0")

FCM84816  
 ▲ ★ R  
 2'8" x 8'0"  
 2'10" x 8'0"  
 3'0" x 8'0"



Mahogany

FCM2050SL  
 ▲ ★ R E  
 12" x 6'8" (7'0")  
 14" x 6'8" (7'0")

FCM84886SL  
 ▲ ★ R E  
 12" x 8'0"  
 14" x 8'0"



Mahogany

FCM4812SL  
 ▲ ★ R  
 12" x 6'8" (7'0")  
 14" x 6'8" (7'0")

FCM84812SL  
 ▲ ★ R  
 12" x 8'0"  
 14" x 8'0"



Smooth

S4812  
 ▲ ★ R E  
 2'8" x 6'8" (7'0")  
 2'10" x 6'8" (7'0")  
 3'0" x 6'8" (7'0")

S84812  
 ▲ ★ R  
 2'8" x 8'0"  
 2'10" x 8'0"  
 3'0" x 8'0"



Smooth

S4813  
 ▲ ★ R E  
 2'8" x 6'8" (7'0")  
 2'10" x 6'8" (7'0")  
 3'0" x 6'8" (7'0")

S84813  
 ▲ ★ R  
 2'8" x 8'0"  
 2'10" x 8'0"  
 3'0" x 8'0"



Smooth

S4814  
 ▲ ★ R E  
 2'8" x 6'8" (7'0")  
 2'10" x 6'8" (7'0")  
 3'0" x 6'8" (7'0")

S84814  
 ▲ ★ R  
 2'8" x 8'0"  
 2'10" x 8'0"  
 3'0" x 8'0"



Smooth

S4816  
 ▲ ★ R E  
 2'8" x 6'8" (7'0")  
 2'10" x 6'8" (7'0")  
 3'0" x 6'8" (7'0")

S84816  
 ▲ ★ R  
 2'8" x 8'0"  
 2'10" x 8'0"  
 3'0" x 8'0"



Smooth

S2010SL  
 ▲ ★ R E  
 10" x 6'8" Δ  
 12" x 6'8" Δ (7'0")  
 14" x 6'8" Δ (7'0")

S84886SL  
 ▲ ★ R  
 12" x 8'0"  
 14" x 8'0"



Smooth

S4812SL  
 ▲ ★ R  
 12" x 6'8" (7'0")  
 14" x 6'8" (7'0")

S84812SL  
 ▲ ★ R  
 12" x 8'0"  
 14" x 8'0"

### CLEAR GLASS



Mahogany

FCM4810  
 ▲ ★ E  
 2'8" x 6'8" (7'0")  
 2'10" x 6'8" (7'0")  
 3'0" x 6'8" (7'0")

FCM84810  
 ▲ ★  
 2'8" x 8'0"  
 2'10" x 8'0"  
 3'0" x 8'0"



Mahogany

FCM2000SL  
 ▲ ★  
 12" x 6'8" (7'0")  
 14" x 6'8" (7'0")

FCM8000SL  
 ▲ ★  
 12" x 8'0"  
 14" x 8'0"



Mahogany

FCM4810SL  
 ▲ ★  
 12" x 6'8" (7'0")  
 14" x 6'8" (7'0")

FCM84810SL  
 ▲ ★  
 12" x 8'0"  
 14" x 8'0"



Smooth

S4810  
 ▲ ★ E  
 2'8" x 6'8" (7'0")  
 2'10" x 6'8" (7'0")  
 3'0" x 6'8" (7'0")

S84810  
 ▲ ★  
 2'8" x 8'0"  
 2'10" x 8'0"  
 3'0" x 8'0"



Smooth

S2000SL  
 ▲ ★  
 10" x 6'8" Δ  
 12" x 6'8" Δ (7'0")  
 14" x 6'8" Δ (7'0")

S8000SL  
 ▲ ★  
 12" x 8'0"  
 14" x 8'0"



Smooth

S4810SL  
 ▲ ★  
 12" x 6'8" (7'0")  
 14" x 6'8" (7'0")

S84810SL  
 ▲ ★  
 12" x 8'0"  
 14" x 8'0"

### Key

- ▲ ★ E Flush-Glazed Glass with Detailed Sticking (FG)
- ▲ ★ Flush-Glazed Glass with Square Sticking (FG)
- ▲ ★ Low-E Glass (LE)

- ▲ ★ Simulated Divided Lites (SDLF1)
- ▲ ★ Flat or Contour White Grilles Between Glass (GBGF / GBGC)
- ▲ ★ Flat Almond Grilles Between Glass (GBGF)

- ▲ ★ Flat Bronze Grilles Between Glass (GBGF)
- ▲ ★ Flat or Contour Black Grilles Between Glass (GBGF / GBGC)
- ▲ ★ Vented Sidelite Options

- ▲ ★ Elevated 10" Bottom Rail Options
- ▲ ★ 6'6" Height Available

# Lite Frames

Therma-Tru® doors and sidelites are available with select lite frame options to complement the door's overall aesthetic.

 For Impact-rated lite frame, see page 27.



The Advanta lite frame is a patented design, U.S. Patent No. 10,655,382.







## Advanta® Lite Frame\*

With a patented design, Advanta lite frames deliver a clean look with no unsightly screw plugs to detract from the entry's overall aesthetic.

Look for the (   ) symbols.

## Standard Lite Frame

With a variety of sizes and shapes to choose from, our standard lite frame features a weather-resistant material and plugs designed to cover the screws.

	Advanta Lite Frame	Standard Lite Frame
<b>Flat Option</b>		
<b>Scrolled Option</b>		
<b>Plugless Design</b>	■	
<b>Buff Option</b>	■	■
<b>White Option</b> (Alpine Color-Matched)	■	■
<b>Durable Weather-Resistant Material</b>	■	■

\*See your Therma-Tru seller for details on product availability.  
 Note: See page 285 for important product details that may help with your purchase decision.

# Full Lites



## TRANSOMS

For transoms, see page 209.

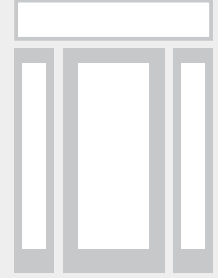

Fiber-Classic® & Smooth-Star®







## BLACKSTONE. ◆ ■



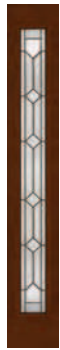

											
Mahogany		Mahogany		Mahogany		Mahogany		Oak		Oak	
FCM108 6E 2'8" x 6'8" 2'10" x 6'8" 3'0" x 6'8"	FCM871 6E 2'8" x 8'0" 2'10" x 8'0" 3'0" x 8'0"	FCM310 6E 2'6" x 6'8" (7'0") 2'8" x 6'8" (7'0") 2'10" x 6'8" (7'0") 3'0" x 6'8" (7'0")	FCM816 6E 2'6" x 8'0" 2'8" x 8'0" 2'10" x 8'0" 3'0" x 8'0"	FCM871SL 6 12" x 8'0" 14" x 8'0"	FCM808SL 6E 10" x 6'8" 12" x 6'8" (7'0") 14" x 6'8" (7'0")	FCM81918SL 6E 12" x 8'0" 14" x 8'0"	FC108 6E 2'6" x 6'8" 2'8" x 6'8" (7'0") 2'10" x 6'8" (7'0") 3'0" x 6'8" (7'0")	81918P 6 2'8" x 8'0" 2'10" x 8'0" 3'0" x 8'0"	FC310 6E 2'6" x 6'8" Δ (7'0") 2'8" x 6'8" Δ (7'0") 2'10" x 6'8" Δ (7'0") 3'0" x 6'8" Δ (7'0")	FC816 6E 2'6" x 8'0" 2'8" x 8'0" 2'10" x 8'0" 3'0" x 8'0"	
											
Oak		Oak		Smooth		Smooth		Smooth		Smooth	
FC108SL 6E 10" x 6'8" 12" x 6'8" 14" x 6'8"	81918PSL 6E 12" x 8'0" 14" x 8'0"	FC808SL 6E 12" x 6'8" Δ (7'0") 14" x 6'8" Δ (7'0")	81918SL 6E 12" x 8'0" 14" x 8'0"	S6002 6E 2'6" x 6'8" 2'8" x 6'8" (7'0") 2'10" x 6'8" (7'0") 3'0" x 6'8" (7'0")	S85892 6E 2'6" x 8'0" 2'8" x 8'0" 2'10" x 8'0" 3'0" x 8'0"	S310 6E 2'6" x 6'8" Δ 2'8" x 6'8" Δ (7'0") 2'10" x 6'8" Δ (7'0") 3'0" x 6'8" Δ (7'0") 3'6" x 6'8"	S816 6E 2'6" x 8'0" 2'8" x 8'0" 2'10" x 8'0" 3'0" x 8'0" 3'6" x 8'0"	S6002SL 6E 12" x 6'8" 14" x 6'8"	S85892SL 6E 12" x 8'0" 14" x 8'0"	S4570SL 6E 12" x 6'8" 14" x 6'8" Δ (7'0")	S85927SL 6E 12" x 8'0" 14" x 8'0"

### Key



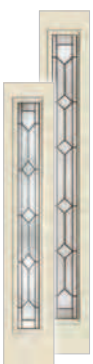

- No Stile Lines
- ◆ Black Nickel Caming (1D)
- ■ Brushed Nickel Caming (1C)
- Scrolled & Flat Advanta Lite Frame  
Not available for 2'4" and 2'6" doors or 10" sidelites.
- Flat Lite Frame
- Vented Sidelite Options
- WBDR Options
- WBDR / HVHZ Options
- Elevated 10" Bottom Rail Options
- ▲ 6'6" Height Available

CRYSTALLINE™ ◆ ◆

										
Mahogany		Mahogany	Mahogany	Oak	Oak					
FCM16 2'8" x 6'8" 2'10" x 6'8" 3'0" x 6'8"	FCM8114 2'8" x 8'0" 2'10" x 8'0" 3'0" x 8'0"	FCM668 2'8" x 6'8" (7'0") 2'10" x 6'8" (7'0") 3'0" x 6'8" (7'0")	FCM814 2'8" x 8'0" 2'10" x 8'0" 3'0" x 8'0"	FCM8114SL 12" x 8'0" 14" x 8'0"	FCM18101SL 10" x 6'8" 12" x 6'8" (7'0") 14" x 6'8" (7'0")	FCM81800SL 12" x 8'0" 14" x 8'0"	FC16 2'8" x 6'8" (7'0") 2'10" x 6'8" (7'0") 3'0" x 6'8" (7'0")	81800P 2'8" x 8'0" 2'10" x 8'0" 3'0" x 8'0"	FC668 2'8" x 6'8" (7'0") 2'10" x 6'8" (7'0") 3'0" x 6'8" (7'0")	FC814 2'8" x 8'0" 2'10" x 8'0" 3'0" x 8'0"

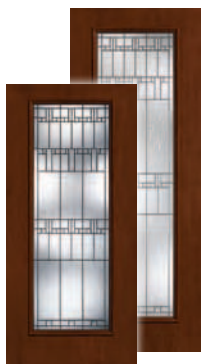
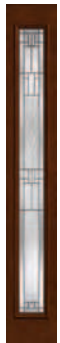
											
Oak	Oak	Smooth	Smooth	Smooth	Smooth						
FC46SL 10" x 6'8" 12" x 6'8" 14" x 6'8"	81800PSL 12" x 8'0" 14" x 8'0"	18101SL 12" x 6'8" Δ (7'0") 14" x 6'8" Δ (7'0")	81800SL 12" x 8'0" 14" x 8'0"	S916 2'8" x 6'8" (7'0") 2'10" x 6'8" (7'0") 3'0" x 6'8" (7'0")	S814 2'8" x 8'0" 2'10" x 8'0" 3'0" x 8'0"	S668 2'8" x 6'8" Δ (7'0") 2'10" x 6'8" Δ (7'0") 3'0" x 6'8" Δ (7'0") 3'6" x 6'8"	S815 2'8" x 8'0" 2'10" x 8'0" 3'0" x 8'0" 3'6" x 8'0"	S916SL 12" x 6'8" 14" x 6'8"	S814SL 12" x 8'0" 14" x 8'0"	S6130SL 10" x 6'8" 12" x 6'8" Δ (7'0") 14" x 6'8" Δ (7'0")	S84586SL 12" x 8'0" 14" x 8'0"

SEDONA ◆ ◆

										
Mahogany		Mahogany	Mahogany	Oak	Oak					
FCM100 2'8" x 6'8" 2'10" x 6'8" 3'0" x 6'8"	FCM872 2'8" x 8'0" 2'10" x 8'0" 3'0" x 8'0"	FCM241 2'6" x 6'8" (7'0") 2'8" x 6'8" (7'0") 2'10" x 6'8" (7'0") 3'0" x 6'8" (7'0")	FCM822 2'8" x 8'0" 2'10" x 8'0" 3'0" x 8'0"	FCM872SL 12" x 8'0" 14" x 8'0"	FCM816SL 10" x 6'8" 12" x 6'8" (7'0") 14" x 6'8" (7'0")	FCM81968SL 12" x 8'0" 14" x 8'0"	FC100 2'6" x 6'8" 2'8" x 6'8" (7'0") 2'10" x 6'8" (7'0") 3'0" x 6'8" (7'0")	81968P 2'8" x 8'0" 2'10" x 8'0" 3'0" x 8'0"	FC241 2'6" x 6'8" Δ (7'0") 2'8" x 6'8" Δ (7'0") 2'10" x 6'8" Δ (7'0") 3'0" x 6'8" Δ (7'0")	FC822 2'8" x 8'0" 2'10" x 8'0" 3'0" x 8'0"

<b>Oak</b>	<b>Oak</b>	<b>Oak</b>	<b>Oak</b>	<b>Smooth</b>	<b>Smooth</b>	<b>Smooth</b>	<b>Smooth</b>
<b>FC100SL</b> 10" x 6'8" 12" x 6'8" 14" x 6'8"	<b>81968PSL</b> 12" x 8'0" 14" x 8'0"	<b>FC816SL</b> 12" x 6'8" Δ (7'0") 14" x 6'8" Δ (7'0")	<b>81968SL</b> 12" x 8'0" 14" x 8'0"	<b>S139</b> 2'6" x 6'8" 2'8" x 6'8" (7'0") 2'10" x 6'8" (7'0") 3'0" x 6'8" (7'0")	<b>S241</b> 2'6" x 6'8" Δ 2'8" x 6'8" Δ (7'0") 2'10" x 6'8" Δ (7'0") 3'0" x 6'8" Δ (7'0") 3'6" x 6'8"	<b>S139SL</b> 12" x 6'8" 14" x 6'8"	<b>S604SL</b> 10" x 6'8" 12" x 6'8" Δ (7'0") 14" x 6'8" Δ (7'0")

**SALINAS. X**

<b>Mahogany</b>	<b>Mahogany</b>	<b>Mahogany</b>	<b>Mahogany</b>	<b>Mahogany</b>	<b>Mahogany</b>	<b>Mahogany</b>	<b>Oak</b>	<b>Oak</b>	<b>Oak</b>	<b>Oak</b>	
<b>FCM113</b> 2'8" x 6'8" 2'10" x 6'8" 3'0" x 6'8"	<b>FCM873</b> 2'8" x 8'0" 2'10" x 8'0" 3'0" x 8'0"	<b>FCM369</b> 2'6" x 6'8" (7'0") 2'8" x 6'8" (7'0") 2'10" x 6'8" (7'0") 3'0" x 6'8" (7'0")	<b>FCM817</b> 2'6" x 8'0" 2'8" x 8'0" 2'10" x 8'0" 3'0" x 8'0"	<b>FCM814SL</b> 10" x 6'8" 12" x 6'8" (7'0") 14" x 6'8" (7'0")	<b>FCM81919SL</b> 12" x 8'0" 14" x 8'0"	<b>FCM873SL</b> 12" x 8'0" 14" x 8'0"	<b>FC113</b> 2'6" x 6'8" 2'8" x 6'8" (7'0") 2'10" x 6'8" (7'0") 3'0" x 6'8" (7'0")	<b>81919P</b> 2'8" x 8'0" 2'10" x 8'0" 3'0" x 8'0"	<b>FC369</b> 2'6" x 6'8" Δ (7'0") 2'8" x 6'8" Δ (7'0") 2'10" x 6'8" Δ (7'0") 3'0" x 6'8" Δ (7'0")	<b>FC817</b> 2'6" x 8'0" 2'8" x 8'0" 2'10" x 8'0" 3'0" x 8'0"	
<b>Oak</b>	<b>Oak</b>	<b>Oak</b>	<b>Oak</b>	<b>Smooth</b>	<b>Smooth</b>	<b>Smooth</b>	<b>Smooth</b>	<b>Smooth</b>	<b>Smooth</b>	<b>Smooth</b>	<b>Smooth</b>
<b>FC113SL</b> 10" x 6'8" 12" x 6'8" 14" x 6'8"	<b>81919PSL</b> 12" x 8'0" 14" x 8'0"	<b>FC814SL</b> 12" x 6'8" Δ (7'0") 14" x 6'8" Δ (7'0")	<b>81919SL</b> 12" x 8'0" 14" x 8'0"	<b>S6008</b> 2'6" x 6'8" 2'8" x 6'8" (7'0") 2'10" x 6'8" (7'0") 3'0" x 6'8" (7'0")	<b>S85893</b> 2'6" x 8'0" 2'8" x 8'0" 2'10" x 8'0" 3'0" x 8'0"	<b>S369</b> 2'6" x 6'8" Δ 2'8" x 6'8" Δ (7'0") 2'10" x 6'8" Δ (7'0") 3'0" x 6'8" Δ (7'0") 3'6" x 6'8"	<b>S817</b> 2'6" x 8'0" 2'8" x 8'0" 2'10" x 8'0" 3'0" x 8'0" 3'6" x 8'0"	<b>S6008SL</b> 12" x 6'8" 14" x 6'8"	<b>S85893SL</b> 12" x 8'0" 14" x 8'0"	<b>S6134SL</b> 10" x 6'8" 12" x 6'8" Δ (7'0") 14" x 6'8" Δ (7'0")	<b>S85931SL</b> 12" x 8'0" 14" x 8'0"

**Key**

- No Stile Lines
- ◆ Black Nickel Caming (1D)
- Brushed Nickel Caming (1C)
- X Wrought Iron (1W)
- Scrolled & Flat Advanta Lite Frame  
Not available for 2'4" and 2'6" doors or 10" sidelites.
- ▲ Flat Lite Frame
- Vented Sidelite Options
- Ⓞ WBDR Options
- Ⓞ WBDR / HVHZ Options
- E Elevated 10" Bottom Rail Options
- Δ 6'6" Height Available



Mahogany

FCM900  
 2'8" x 6'8"  
 2'10" x 6'8"  
 3'0" x 6'8"



Mahogany

FCM1006  
 2'8" x 6'8" (7'0")  
 2'10" x 6'8" (7'0")  
 3'0" x 6'8" (7'0")

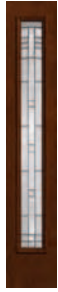

Mahogany

FCM812SL  
 10" x 6'8"  
 12" x 6'8" (7'0")  
 14" x 6'8" (7'0")



Oak

FC900  
 2'8" x 6'8" (7'0")  
 2'10" x 6'8" (7'0")  
 3'0" x 6'8" (7'0")



Oak

FC1006  
 2'8" x 6'8" (7'0")  
 2'10" x 6'8" (7'0")  
 3'0" x 6'8" (7'0")



Oak

FC900SL  
 10" x 6'8"  
 12" x 6'8"  
 14" x 6'8"



Oak

FC812SL  
 12" x 6'8" (7'0")  
 14" x 6'8" (7'0")



Smooth

S6100  
 2'8" x 6'8" (7'0")  
 2'10" x 6'8" (7'0")  
 3'0" x 6'8" (7'0")

SARATOGA.™ ◆ ◆



Smooth

S1006  
 2'8" x 6'8" (7'0")  
 2'10" x 6'8" (7'0")  
 3'0" x 6'8" (7'0")  
 3'6" x 6'8"



Smooth

S6100SL  
 12" x 6'8"  
 14" x 6'8"



Smooth

S6131SL  
 10" x 6'8"  
 12" x 6'8" (7'0")  
 14" x 6'8" (7'0")



Mahogany

FCM905  
 2'8" x 6'8"  
 2'10" x 6'8"  
 3'0" x 6'8"



Mahogany

FCM6093  
 2'6" x 6'8" (7'0")  
 2'8" x 6'8" (7'0")  
 2'10" x 6'8" (7'0")  
 3'0" x 6'8" (7'0")



Mahogany

FCM815SL  
 10" x 6'8"  
 12" x 6'8" (7'0")  
 14" x 6'8" (7'0")



Mahogany

FCM81986SL  
 12" x 8'0"  
 14" x 8'0"



Oak

FC905  
 2'6" x 6'8"  
 2'8" x 6'8" (7'0")  
 2'10" x 6'8" (7'0")  
 3'0" x 6'8" (7'0")



Oak

FCM6093  
 2'6" x 6'8" (7'0")  
 2'8" x 6'8" (7'0")  
 2'10" x 6'8" (7'0")  
 3'0" x 6'8" (7'0")



Oak

FC905SL  
 10" x 6'8"  
 12" x 6'8"  
 14" x 6'8"



Oak

FC815SL  
 12" x 6'8" (7'0")  
 14" x 6'8" (7'0")



Smooth

S154  
 2'6" x 6'8"  
 2'8" x 6'8" (7'0")  
 2'10" x 6'8" (7'0")  
 3'0" x 6'8" (7'0")



Smooth

S6093  
 2'6" x 6'8" (7'0")  
 2'8" x 6'8" (7'0")  
 2'10" x 6'8" (7'0")  
 3'0" x 6'8" (7'0")  
 3'6" x 6'8"



Smooth

S154SL  
 12" x 6'8"  
 14" x 6'8"



Smooth

S8602SL  
 12" x 8'0"  
 14" x 8'0"

**TEXAS STAR** ◆ ◆ ◆

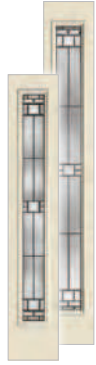

Smooth

S602SL  
 ■ ● ◆ ◆ ◆  
 10" x 6'8"  
 12" x 6'8" △ (7'0")  
 14" x 6'8" △ (7'0")

S85932SL  
 ■ ● ◆ ◆ ◆  
 12" x 8'0"  
 14" x 8'0"



Mahogany

FCM142  
 ◆  
 2'8" x 6'8"  
 2'10" x 6'8"  
 3'0" x 6'8"



Mahogany

FCM1029  
 ■ ◆ ◆ E  
 2'8" x 6'8" (7'0")  
 2'10" x 6'8" (7'0")  
 3'0" x 6'8" (7'0")



Mahogany

FCM817SL  
 ■ ● ◆ ◆ ◆  
 10" x 6'8"  
 12" x 6'8" (7'0")  
 14" x 6'8" (7'0")



Oak

FC142  
 ◆ E  
 2'8" x 6'8" (7'0")  
 2'10" x 6'8" (7'0")  
 3'0" x 6'8" (7'0")



Oak

FC1029  
 ■ ◆ ◆ E  
 2'8" x 6'8" △ (7'0")  
 2'10" x 6'8" △ (7'0")  
 3'0" x 6'8" △ (7'0")



Oak

FC142SL  
 ◆  
 10" x 6'8"  
 12" x 6'8"  
 14" x 6'8"

**WELLESLEY** ◆ ◆ ◆ ◆



Oak

FC817SL  
 ■ ● ◆ ◆ ◆  
 12" x 6'8" △ (7'0")  
 14" x 6'8" △ (7'0")

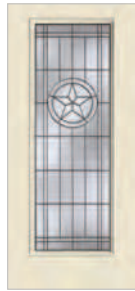

Smooth

S6070  
 ◆ E  
 2'8" x 6'8" (7'0")  
 2'10" x 6'8" (7'0")  
 3'0" x 6'8" (7'0")

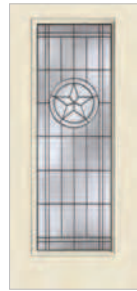

Smooth

S1029  
 ■ ◆ ◆ E  
 2'8" x 6'8" △ (7'0")  
 2'10" x 6'8" △ (7'0")  
 3'0" x 6'8" △ (7'0")  
 3'6" x 6'8"

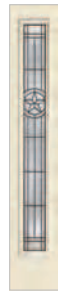

Smooth

S6070SL  
 ◆  
 12" x 6'8"  
 14" x 6'8"

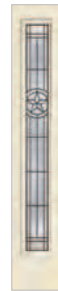

Smooth

S6135SL  
 ■ ● ◆ ◆ ◆  
 10" x 6'8"  
 12" x 6'8" △ (7'0")  
 14" x 6'8" △ (7'0")



Mahogany

FCM104  
 ◆ ◆  
 2'8" x 6'8"  
 2'10" x 6'8"  
 3'0" x 6'8"

FCM874  
 ◆ ◆  
 2'8" x 8'0"  
 2'10" x 8'0"  
 3'0" x 8'0"



Mahogany

FCM6094  
 ■ ◆ ◆ E  
 2'6" x 6'8" (7'0")  
 2'8" x 6'8" (7'0")  
 2'10" x 6'8" (7'0")  
 3'0" x 6'8" (7'0")



Mahogany

FCM821  
 ■ ◆ ◆ ◆  
 2'6" x 8'0"  
 2'8" x 8'0"  
 2'10" x 8'0"  
 3'0" x 8'0"



Mahogany

FCM818SL  
 ■ ● ◆ ◆ ◆  
 10" x 6'8"  
 12" x 6'8" (7'0")  
 14" x 6'8" (7'0")



Oak

FCM81921SL  
 ■ ● ◆ ◆ ◆  
 12" x 8'0"  
 14" x 8'0"



Oak

FCM874SL  
 ◆ ◆  
 12" x 8'0"  
 14" x 8'0"



Oak

FC104  
 ◆ ◆ E  
 2'6" x 6'8"  
 2'8" x 6'8" (7'0")  
 2'10" x 6'8" (7'0")  
 3'0" x 6'8" (7'0")

81921P  
 ◆ ◆ ◆  
 2'8" x 8'0"  
 2'10" x 8'0"  
 3'0" x 8'0"

**WELLESLEY** Continues on next page.













**Key**

- No Stile Lines
- ◆ Black Nickel Caming (1D)
- ◆ Brushed Nickel Caming (1C)
- ◆ Brass Caming (1A)

- ◆ Flat Lite Frame
- ◆ Scrolled & Flat Advanta Lite Frame  
Not available for 2'4" and 2'6" doors or 10" sidelites.

- Vented Sidelite Options
- ◆ WBDR Options
- ◆ WBDR / HVHZ Options

- E Elevated 10" Bottom Rail Options
- △ 6'6" Height Available

				
<b>Oak</b>	<b>Oak</b>	<b>Smooth</b>	<b>Smooth</b>	<b>Smooth</b>
FC104SL  10" x 6'8" 12" x 6'8" 14" x 6'8"	81921PSL  12" x 8'0" 14" x 8'0"	S155  2'6" x 6'8" 2'8" x 6'8" (7'0") 2'10" x 6'8" (7'0") 3'0" x 6'8" (7'0")	S6094  2'6" x 6'8" Δ 2'8" x 6'8" Δ (7'0") 2'10" x 6'8" Δ (7'0") 3'0" x 6'8" Δ (7'0") 3'6" x 6'8"	S155SL  12" x 6'8" 14" x 6'8"
		S85896  2'6" x 8'0" 2'8" x 8'0" 2'10" x 8'0" 3'0" x 8'0"	S821  2'6" x 8'0" 2'8" x 8'0" 2'10" x 8'0" 3'0" x 8'0" 3'6" x 8'0"	S85896SL  12" x 8'0" 14" x 8'0"

**RISERVA. X**

				
<b>Smooth</b>	<b>Mahogany</b>	<b>Mahogany</b>	<b>Mahogany</b>	<b>Mahogany</b>
S5870SL  10" x 6'8" 12" x 6'8" Δ (7'0") 14" x 6'8" Δ (7'0")	S85934SL  12" x 8'0" 14" x 8'0"	FCM574  2'8" x 6'8" 2'10" x 6'8" 3'0" x 6'8"	FCM571  2'6" x 6'8" (7'0") 2'8" x 6'8" (7'0") 2'10" x 6'8" (7'0") 3'0" x 6'8" (7'0")	FCM8573SL  12" x 8'0" 14" x 8'0"
	FCM8574  2'8" x 8'0" 2'10" x 8'0" 3'0" x 8'0"	FCM8571  2'6" x 8'0" 2'8" x 8'0" 2'10" x 8'0" 3'0" x 8'0"	FCM572SL  10" x 6'8" 12" x 6'8" (7'0") 14" x 6'8" (7'0")	FCM8572SL  12" x 8'0" 14" x 8'0"
				
<b>Oak</b>	<b>Oak</b>	<b>Oak</b>	<b>Oak</b>	<b>Smooth</b>
FC574  2'6" x 6'8" 2'8" x 6'8" (7'0") 2'10" x 6'8" (7'0") 3'0" x 6'8" (7'0")	FC8574  2'8" x 8'0" 2'10" x 8'0" 3'0" x 8'0"	FC571  2'6" x 6'8" Δ (7'0") 2'8" x 6'8" Δ (7'0") 2'10" x 6'8" Δ (7'0") 3'0" x 6'8" Δ (7'0")	FC572SL  12" x 6'8" Δ (7'0") 14" x 6'8" Δ (7'0")	S574  2'6" x 6'8" 2'8" x 6'8" (7'0") 2'10" x 6'8" (7'0") 3'0" x 6'8" (7'0")
		FC8571  2'6" x 8'0" 2'8" x 8'0" 2'10" x 8'0" 3'0" x 8'0"	FC8572SL  12" x 8'0" 14" x 8'0"	S8574  2'6" x 8'0" 2'8" x 8'0" 2'10" x 8'0" 3'0" x 8'0"





Smooth

S571



2'6" x 6'8"  $\Delta$   
2'8" x 6'8"  $\Delta$  (7'0")  
2'10" x 6'8"  $\Delta$  (7'0")  
3'0" x 6'8"  $\Delta$  (7'0")  
3'6" x 6'8"



Smooth

S8571



2'6" x 8'0"  
2'8" x 8'0"  
2'10" x 8'0"  
3'0" x 8'0"  
3'6" x 8'0"



Smooth

S573SL



12" x 6'8"  
14" x 6'8"

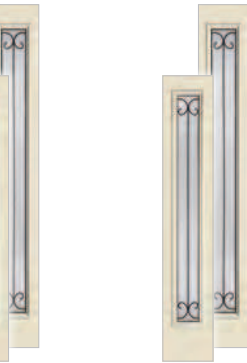

Smooth

S8573SL



12" x 8'0"  
14" x 8'0"

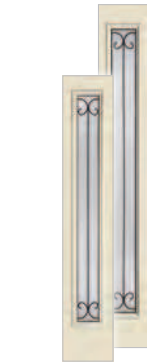

Smooth

S572SL



10" x 6'8"  
12" x 6'8"  $\Delta$  (7'0")  
14" x 6'8"  $\Delta$  (7'0")



Smooth

S8572SL



12" x 8'0"  
14" x 8'0"



Mahogany

FCM910



2'8" x 6'8"  
2'10" x 6'8"  
3'0" x 6'8"



Mahogany

FCM890



2'8" x 8'0"  
2'10" x 8'0"  
3'0" x 8'0"



Mahogany

FCM6095



2'6" x 6'8" (7'0")  
2'8" x 6'8" (7'0")  
2'10" x 6'8" (7'0")  
3'0" x 6'8" (7'0")

FCM820



2'6" x 8'0"  
2'8" x 8'0"  
2'10" x 8'0"  
3'0" x 8'0"



Mahogany

FCM809SL



10" x 6'8"  
12" x 6'8"  $\Delta$  (7'0")  
14" x 6'8"  $\Delta$  (7'0")



Mahogany

FCM81928SL



12" x 8'0"  
14" x 8'0"



Oak

FC910



2'6" x 6'8"  
2'8" x 6'8" (7'0")  
2'10" x 6'8" (7'0")  
3'0" x 6'8" (7'0")



Oak

81928P



2'8" x 8'0"  
2'10" x 8'0"  
3'0" x 8'0"



Oak

FCM6095



2'6" x 6'8"  $\Delta$  (7'0")  
2'8" x 6'8"  $\Delta$  (7'0")  
2'10" x 6'8"  $\Delta$  (7'0")  
3'0" x 6'8"  $\Delta$  (7'0")



Oak

FC820



2'6" x 8'0"  
2'8" x 8'0"  
2'10" x 8'0"  
3'0" x 8'0"



Oak

FC910SL



10" x 6'8"  
12" x 6'8"  
14" x 6'8"



Oak

81928PSL



12" x 8'0"  
14" x 8'0"



Oak

FC809SL



12" x 6'8"  $\Delta$  (7'0")  
14" x 6'8"  $\Delta$  (7'0")



81928SL



12" x 8'0"  
14" x 8'0"



Smooth

S6090



2'6" x 6'8"  
2'8" x 6'8" (7'0")  
2'10" x 6'8" (7'0")  
3'0" x 6'8" (7'0")



Smooth

S85895



2'6" x 8'0"  
2'8" x 8'0"  
2'10" x 8'0"  
3'0" x 8'0"



Smooth

S6095



2'6" x 6'8"  $\Delta$   
2'8" x 6'8"  $\Delta$  (7'0")  
2'10" x 6'8"  $\Delta$  (7'0")  
3'0" x 6'8"  $\Delta$  (7'0")  
3'6" x 6'8"

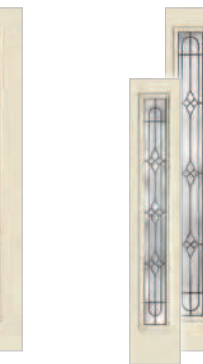

Smooth

S820



2'6" x 8'0"  
2'8" x 8'0"  
2'10" x 8'0"  
3'0" x 8'0"  
3'6" x 8'0"

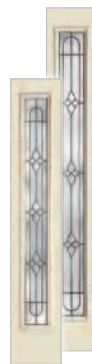

Smooth

S416SL



12" x 6'8"  
14" x 6'8"



Smooth

S85895SL



12" x 8'0"  
14" x 8'0"



Smooth

S4070SL



10" x 6'8"  
12" x 6'8"  $\Delta$  (7'0")  
14" x 6'8"  $\Delta$  (7'0")



Smooth

S85930SL



12" x 8'0"  
14" x 8'0"

Key

- No Stile Lines
- ◆ Black Nickel Caming (1D)
- Brushed Nickel Caming (1C)

- ◆ Brass Caming (1A)
- ✗ Wrought Iron (1W)
- ▢ Flat Lite Frame

- ▢ Scrolled & Flat Advanta Lite Frame  
Not available for 2'4" and 2'6" doors or 10" sidelites.
- Vented Sidelite Options

- 6 WBDR Options
- 6 WBDR / HVHZ Options
- E Elevated 10" Bottom Rail Options

$\Delta$  6'6" Height Available



Mahogany

FCM148

2'8" x 6'8"  
2'10" x 6'8"  
3'0" x 6'8"



Mahogany

FCM626

2'8" x 6'8" (7'0")  
2'10" x 6'8" (7'0")  
3'0" x 6'8" (7'0")



Mahogany

FCM813SL

10" x 6'8"  
12" x 6'8" (7'0")  
14" x 6'8" (7'0")



Oak

FC148

2'8" x 6'8" (7'0")  
2'10" x 6'8" (7'0")  
3'0" x 6'8" (7'0")



Oak

FC626

2'8" x 6'8" Δ (7'0")  
2'10" x 6'8" Δ (7'0")  
3'0" x 6'8" Δ (7'0")



Oak

FC148SL

10" x 6'8"  
12" x 6'8"  
14" x 6'8"



Oak

FC813SL

12" x 6'8" Δ (7'0")  
14" x 6'8" Δ (7'0")



Smooth

S160

2'8" x 6'8" (7'0")  
2'10" x 6'8" (7'0")  
3'0" x 6'8" (7'0")

PEMBRIDGE™ ◆ ◆ ◆



Smooth

S626

2'8" x 6'8" Δ (7'0")  
2'10" x 6'8" Δ (7'0")  
3'0" x 6'8" Δ (7'0")  
3'6" x 6'8"



Smooth

S160SL

12" x 6'8"  
14" x 6'8"



Smooth

S6132SL

12" x 6'8" Δ (7'0")  
14" x 6'8" Δ (7'0")



Mahogany

FCM6550

2'8" x 6'8"  
2'10" x 6'8"  
3'0" x 6'8"



Mahogany

FCM86550

2'8" x 8'0"  
2'10" x 8'0"  
3'0" x 8'0"



Mahogany

FCM6500

2'4" x 6'8"  
2'6" x 6'8" (7'0")  
2'8" x 6'8" (7'0")  
2'10" x 6'8" (7'0")  
3'0" x 6'8" (7'0")

FCM86500

2'6" x 8'0"  
2'8" x 8'0"  
2'10" x 8'0"  
3'0" x 8'0"

FCM86550SL

12" x 8'0"  
14" x 8'0"

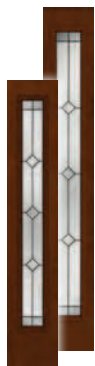

Mahogany

FCM6500SL

10" x 6'8"  
12" x 6'8" (7'0")  
14" x 6'8" (7'0")



Oak

FCM86500SL

12" x 8'0"  
14" x 8'0"



Oak

FC6550

2'8" x 6'8" (7'0")  
2'10" x 6'8" (7'0")  
3'0" x 6'8" (7'0")



Oak

FC86550

2'8" x 8'0"  
2'10" x 8'0"  
3'0" x 8'0"



Oak

FC6500

2'4" x 6'8"  
2'6" x 6'8" (7'0")  
2'8" x 6'8" Δ (7'0")  
2'10" x 6'8" Δ (7'0")  
3'0" x 6'8" Δ (7'0")



Oak

FC86500

2'6" x 8'0"  
2'8" x 8'0"  
2'10" x 8'0"  
3'0" x 8'0"



Oak

FC6550SL

10" x 6'8"  
12" x 6'8"  
14" x 6'8"



Oak

FC86500SL

12" x 8'0" Δ (7'0")  
14" x 8'0" Δ (7'0")



Smooth

S6550  
 2'8" x 6'8" (7'0")  
 2'10" x 6'8" (7'0")  
 3'0" x 6'8" (7'0")



Smooth

S86500  
 2'8" x 8'0"  
 2'10" x 8'0"  
 2'6" x 6'8" Δ  
 2'8" x 6'8" Δ (7'0")  
 2'10" x 6'8" Δ (7'0")  
 3'0" x 6'8" Δ (7'0")  
 3'6" x 6'8"

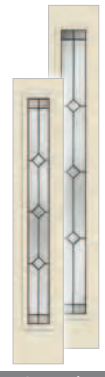

Smooth

S6550SL  
 12" x 6'8"  
 14" x 6'8"

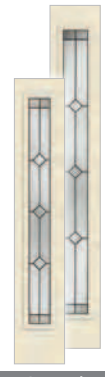

Smooth

S86500SL  
 12" x 8'0"  
 14" x 8'0"



Mahogany

FCM1652  
 2'8" x 6'8"  
 2'10" x 6'8"  
 3'0" x 6'8"



Mahogany

FCM1651  
 2'4" x 6'8"  
 2'6" x 6'8" (7'0")  
 2'8" x 6'8" (7'0")  
 2'10" x 6'8" (7'0")  
 3'0" x 6'8" (7'0")



Mahogany

FCM81651SL  
 10" x 6'8"  
 12" x 6'8" (7'0")  
 14" x 6'8" (7'0")



Mahogany

FCM81652SL  
 12" x 8'0"  
 14" x 8'0"



Oak

FC1652  
 2'6" x 6'8"  
 2'8" x 6'8" (7'0")  
 2'10" x 6'8" (7'0")  
 3'0" x 6'8" (7'0")



Oak

FC81652  
 2'8" x 8'0"  
 2'10" x 8'0"  
 3'0" x 8'0"



Oak

FC81651SL  
 10" x 6'8"  
 12" x 6'8"  
 14" x 6'8"

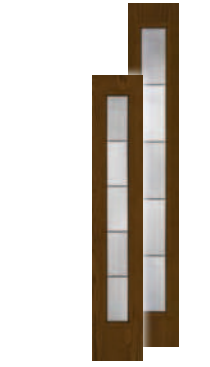

Oak

FC1651SL  
 12" x 6'8" Δ (7'0")  
 14" x 6'8" Δ (7'0")



Smooth

S1652  
 2'6" x 6'8"  
 2'8" x 6'8" (7'0")  
 2'10" x 6'8" (7'0")  
 3'0" x 6'8" (7'0")



Smooth

S81652SL  
 2'6" x 8'0"  
 2'8" x 8'0"  
 2'10" x 8'0"  
 3'0" x 8'0"  
 3'6" x 8'0"



Smooth

S1651SL  
 10" x 6'8"  
 12" x 6'8" Δ (7'0")  
 14" x 6'8" Δ (7'0")



Smooth

S81651SL  
 12" x 8'0"  
 14" x 8'0"

**Key**

- No Stile Lines
- ♦ Black Nickel Caming (1D)
- Brushed Nickel Caming (1C)
- ♦ Brass Caming (1A)

- ▤ Flat Lite Frame
- ▤ Scrolled & Flat Advanta Lite Frame  
Not available for 2'4" and 2'6" doors or 10" sidelites.

- Vented Sidelite Options
- 6 WBDR Options
- 6 WBDR / HVHZ Options

- E Elevated 10" Bottom Rail Options
- Δ 6" Height Available

## CALIX



Mahogany

FCM2223  
 2'8" x 6'8"  
 2'10" x 6'8"  
 3'0" x 6'8"

FCM82223  
 2'8" x 8'0"  
 2'10" x 8'0"  
 3'0" x 8'0"

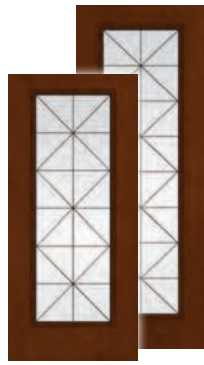

Mahogany

FCM2389  
 2'8" x 6'8" (7'0")  
 2'10" x 6'8" (7'0")  
 3'0" x 6'8" (7'0")

FCM82389  
 2'8" x 8'0"  
 2'10" x 8'0"  
 3'0" x 8'0"



Mahogany

FCM2389SL  
 10" x 6'8"  
 12" x 6'8" (7'0")  
 14" x 6'8" (7'0")

FCM82389SL  
 12" x 8'0"  
 14" x 8'0"



Mahogany

FCM82223SL  
 12" x 8'0"  
 14" x 8'0"



Oak

FC2223  
 2'8" x 6'8" (7'0")  
 2'10" x 6'8" (7'0")  
 3'0" x 6'8" (7'0")

FC82223  
 2'8" x 8'0"  
 2'10" x 8'0"  
 3'0" x 8'0"



Oak

FC2389  
 2'8" x 6'8" (7'0")  
 2'10" x 6'8" (7'0")  
 3'0" x 6'8" (7'0")

FC82389  
 2'8" x 8'0"  
 2'10" x 8'0"  
 3'0" x 8'0"



Oak

FC2223SL  
 10" x 6'8"  
 12" x 6'8"  
 14" x 6'8"

FC82223SL  
 12" x 8'0"  
 14" x 8'0"



Oak

FC2389SL  
 12" x 6'8" (7'0")  
 14" x 6'8" (7'0")

FC82389SL  
 12" x 8'0"  
 14" x 8'0"

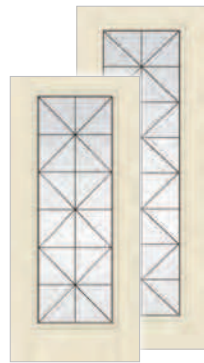

Smooth

S2223  
 2'8" x 6'8" (7'0")  
 2'10" x 6'8" (7'0")  
 3'0" x 6'8" (7'0")

S82223  
 2'8" x 8'0"  
 2'10" x 8'0"  
 3'0" x 8'0"

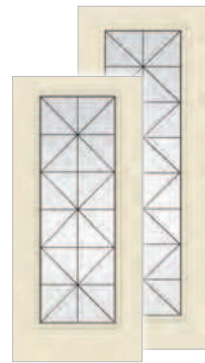

Smooth

S2389  
 2'8" x 6'8" (7'0")  
 2'10" x 6'8" (7'0")  
 3'0" x 6'8" (7'0")  
 3'6" x 6'8"

S82389  
 2'8" x 8'0"  
 2'10" x 8'0"  
 3'0" x 8'0"  
 3'6" x 8'0"

## LATITUDE

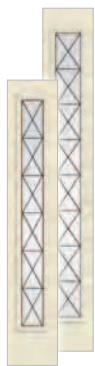

Smooth

S2223SL  
 12" x 6'8"  
 14" x 6'8"

S82223SL  
 12" x 8'0"  
 14" x 8'0"

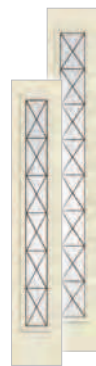

Smooth

S2389SL  
 10" x 6'8"  
 12" x 6'8" (7'0")  
 14" x 6'8" (7'0")

S82389SL  
 12" x 8'0"  
 14" x 8'0"

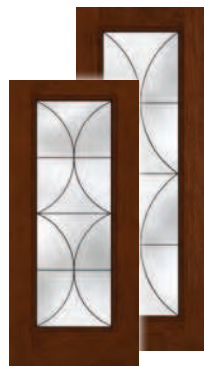

Mahogany

FCM2213  
 2'8" x 6'8"  
 2'10" x 6'8"  
 3'0" x 6'8"

FCM82213  
 2'8" x 8'0"  
 2'10" x 8'0"  
 3'0" x 8'0"



Mahogany

FCM2382  
 2'8" x 6'8" (7'0")  
 2'10" x 6'8" (7'0")  
 3'0" x 6'8" (7'0")





FCM82382  
 2'8" x 8'0"  
 2'10" x 8'0"  
 3'0" x 8'0"









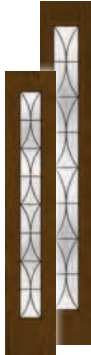

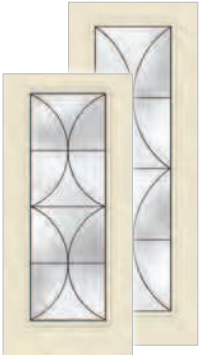
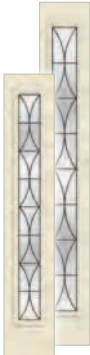
Mahogany

FCM2382SL  
 10" x 6'8"  
 12" x 6'8" (7'0")  
 14" x 6'8" (7'0")

FCM82382SL  
 12" x 8'0"  
 14" x 8'0"

				
<b>Mahogany</b>	<b>Oak</b>	<b>Oak</b>	<b>Oak</b>	<b>Oak</b>
FCM82213SL 6 12" x 8'0" 14" x 8'0"	FC2213 6E 2'8" x 6'8" (7'0") 2'10" x 6'8" (7'0") 3'0" x 6'8" (7'0")	FC82213 6 2'8" x 8'0" 2'10" x 8'0" 3'0" x 8'0"	FC2382 6E 2'8" x 6'8" (7'0") 2'10" x 6'8" (7'0") 3'0" x 6'8" (7'0")	FC82382 6 2'8" x 8'0" 2'10" x 8'0" 3'0" x 8'0"
FC2213SL 6 10" x 6'8" 12" x 6'8" 14" x 6'8"	FC82213SL 6 12" x 8'0" 14" x 8'0"	FC2382SL 6E 12" x 6'8" (7'0") 14" x 6'8" (7'0")	FC82382SL 6 12" x 8'0" 14" x 8'0"	

				
<b>Smooth</b>	<b>Smooth</b>	<b>Smooth</b>	<b>Smooth</b>	<b>Mahogany</b>
S2213 6E 2'8" x 6'8" (7'0") 2'10" x 6'8" (7'0") 3'0" x 6'8" (7'0")	S82213 6 2'8" x 8'0" 2'10" x 8'0" 3'0" x 8'0"	S2382 6E 2'8" x 6'8" (7'0") 2'10" x 6'8" (7'0") 3'0" x 6'8" (7'0") 3'6" x 6'8"	S82382 6 2'8" x 8'0" 2'10" x 8'0" 3'0" x 8'0" 3'6" x 8'0"	S2213SL 6 12" x 6'8" 14" x 6'8"
S82213SL 6 12" x 8'0" 14" x 8'0"	S2382SL 6E 10" x 6'8" 12" x 6'8" (7'0") 14" x 6'8" (7'0")	S82382SL 6 12" x 8'0" 14" x 8'0"		FCM2233 6 2'8" x 6'8" 2'10" x 6'8" 3'0" x 6'8"
				FC82233 6 2'8" x 8'0" 2'10" x 8'0" 3'0" x 8'0"













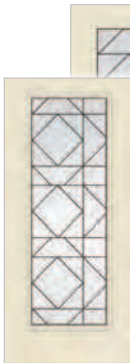

				
<b>Mahogany</b>	<b>Mahogany</b>	<b>Mahogany</b>	<b>Oak</b>	<b>Oak</b>
FCM2385 6E 2'8" x 6'8" (7'0") 2'10" x 6'8" (7'0") 3'0" x 6'8" (7'0")	FCM82385 6 2'8" x 8'0" 2'10" x 8'0" 3'0" x 8'0"	FC2385SL 6E 10" x 6'8" 12" x 6'8" (7'0") 14" x 6'8" (7'0")	FCM82385SL 6E 12" x 8'0" 14" x 8'0"	FCM82233SL 6 12" x 8'0" 14" x 8'0"
			FC2233 6E 2'8" x 6'8" (7'0") 2'10" x 6'8" (7'0") 3'0" x 6'8" (7'0")	FC82233 6 2'8" x 8'0" 2'10" x 8'0" 3'0" x 8'0"
				FC2385 6E 2'8" x 6'8" (7'0") 2'10" x 6'8" (7'0") 3'0" x 6'8" (7'0")
				FC82385 6 2'8" x 8'0" 2'10" x 8'0" 3'0" x 8'0"

**ECHELON** ◆ ◆ ◆

**ECHELON** Continues on next page.

**Key**

- No Stile Lines
- ◆ Black Nickel Caming (1D)
- Brushed Nickel Caming (1C)
- ◆ Brass Caming (1A)
- Scrolled & Flat Advanta Lite Frame  
Not available for 2'4" and 2'6" doors or 10" sidelites.
- Vented Sidelite Options
- E Elevated 10" Bottom Rail Options
- 6 WBDR Options
- 6 WBDR / HVHZ Options
- △ 6'6" Height Available

									
<b>Oak</b>	<b>Oak</b>	<b>Smooth</b>	<b>Smooth</b>	<b>Smooth</b>					
<b>FC2233SL</b>  10" x 6'8" 12" x 6'8" 14" x 6'8"	<b>FC82233SL</b>  12" x 8'0" 14" x 8'0"	<b>FC2385SL</b>  12" x 6'8" Δ (7'0") 14" x 6'8" Δ (7'0")	<b>FC82385SL</b>  12" x 8'0" 14" x 8'0"	<b>S2233</b>  2'8" x 6'8" (7'0") 2'10" x 6'8" (7'0") 3'0" x 6'8" (7'0")	<b>S82233</b>  2'8" x 8'0" 2'10" x 8'0" 3'0" x 8'0"	<b>S2385</b>  2'8" x 6'8" Δ (7'0") 2'10" x 6'8" Δ (7'0") 3'0" x 6'8" Δ (7'0") 3'6" x 6'8"	<b>S82385</b>  2'8" x 8'0" 2'10" x 8'0" 3'0" x 8'0" 3'6" x 8'0"	<b>S2233SL</b>  12" x 6'8" 14" x 6'8"	<b>S82233SL</b>  12" x 8'0" 14" x 8'0"

**PRIVACY & TEXTURED GLASS WITH DIVIDED LITES**

					
<b>Smooth</b>	<b>Mahogany</b>	<b>Mahogany</b>	<b>Mahogany</b>	<b>Mahogany</b>	<b>Mahogany</b>
<b>S2385SL</b>  10" x 6'8" 12" x 6'8" Δ (7'0") 14" x 6'8" Δ (7'0")	<b>S82385SL</b>  12" x 8'0" 14" x 8'0"	<b>FCM138_</b>  2'8" x 6'8" 2'10" x 6'8" 3'0" x 6'8"	<b>FCM1285_</b>  2'8" x 6'8" (7'0") 2'10" x 6'8" (7'0") 3'0" x 6'8" (7'0")	<b>FCM18_</b>  2'8" x 6'8" 2'10" x 6'8" 3'0" x 6'8"	<b>FCM1284_</b>  2'8" x 6'8" (7'0") 2'10" x 6'8" (7'0") 3'0" x 6'8" (7'0")

						
<b>Mahogany</b>	<b>Mahogany</b>	<b>Mahogany</b>	<b>Oak</b>	<b>Oak</b>	<b>Oak</b>	<b>Oak</b>
<b>FCM6124_SL*</b>  10" x 6'8" 12" x 6'8" (7'0") 14" x 6'8" (7'0")	<b>FCM6125_SL*</b>  10" x 6'8" 12" x 6'8" (7'0") 14" x 6'8" (7'0")	<b>FCM6126_SL*</b>  10" x 6'8" 12" x 6'8" (7'0") 14" x 6'8" (7'0")	<b>FC138_</b>  2'8" x 6'8" (7'0") 2'10" x 6'8" (7'0") 3'0" x 6'8" (7'0")	<b>1285_</b>  2'8" x 6'8" Δ (7'0") 2'10" x 6'8" Δ (7'0") 3'0" x 6'8" Δ (7'0")	<b>FC18_</b>  2'8" x 6'8" (7'0") 2'10" x 6'8" (7'0") 3'0" x 6'8" (7'0")	<b>1284_</b>  2'8" x 6'8" Δ (7'0") 2'10" x 6'8" Δ (7'0") 3'0" x 6'8" Δ (7'0")

**Privacy & Textured Glass Options**

Add the code to the blank in the style number for the desired door and glass combination. For details on glass options, see page 119.

XK = Reeded

XE = Satin Etch

XC = Chord

XJ = Chinchilla

XR = Rainglass

XN = Granite

\*Not available with Reeded (XK) glass.

Note: See page 285 for important product details that may help with your purchase decision.

Oak	Oak	Oak	Oak	Oak	Oak	Oak	Oak
FC18_SL 10" x 6'8" 12" x 6'8" 14" x 6'8"	12102_SL 12" x 6'8" ⚠ (7'0") 14" x 6'8" ⚠ (7'0")	FC06188_SL* 10" x 6'8" 12" x 6'8" 14" x 6'8"	FC06184_SL* 12" x 6'8" ⚠ (7'0") 14" x 6'8" ⚠ (7'0")	FC06189_SL* 10" x 6'8" 12" x 6'8" 14" x 6'8"	FC06185_SL* 12" x 6'8" ⚠ (7'0") 14" x 6'8" ⚠ (7'0")	FC06190_SL* 10" x 6'8" 12" x 6'8" 14" x 6'8"	FC06186_SL* 12" x 6'8" ⚠ (7'0") 14" x 6'8" ⚠ (7'0")

Smooth	Smooth	Smooth	Smooth	Smooth	Smooth	Smooth
S128_ 2'8" x 6'8" (7'0") 2'10" x 6'8" (7'0") 3'0" x 6'8" (7'0")	S141_ 2'8" x 6'8" ⚠ (7'0") 2'10" x 6'8" ⚠ (7'0") 3'0" x 6'8" ⚠ (7'0") 3'6" x 6'8"	S108_ 2'8" x 6'8" (7'0") 2'10" x 6'8" (7'0") 3'0" x 6'8" (7'0")	S6063_ 2'8" x 6'8" ⚠ (7'0") 2'10" x 6'8" ⚠ (7'0") 3'0" x 6'8" ⚠ (7'0") 3'6" x 6'8"	S308_SL 12" x 6'8" 14" x 6'8"	S1170_SL 10" x 6'8" 12" x 6'8" ⚠ (7'0") 14" x 6'8" ⚠ (7'0")	S605_SL* 12" x 6'8" 14" x 6'8"

Smooth	Smooth	Smooth	Smooth	Smooth
S6124_SL* 10" x 6'8" 12" x 6'8" ⚠ (7'0") 14" x 6'8" ⚠ (7'0")	S606_SL* 12" x 6'8" 14" x 6'8"	S6125_SL* 10" x 6'8" 12" x 6'8" ⚠ (7'0") 14" x 6'8" ⚠ (7'0")	S607_SL* 12" x 6'8" 14" x 6'8"	S6126_SL* 10" x 6'8" 12" x 6'8" ⚠ (7'0") 14" x 6'8" ⚠ (7'0")

**PRIVACY & TEXTURED GLASS**





Mahogany	Mahogany	Mahogany	Mahogany
FCM10_ 2'8" x 6'8" 2'10" x 6'8" 3'0" x 6'8"	FCM870_ 2'8" x 8'0" 2'10" x 8'0" 3'0" x 8'0"	FCM1283_ 2'8" x 6'8" (7'0") 2'10" x 6'8" (7'0") 3'0" x 6'8" (7'0")	FCM81200_ 2'6" x 8'0" 2'10" x 8'0" 3'0" x 8'0"





PRIVACY & TEXTURED GLASS *Continues on next page.*

**Key**





- No Stile Lines
- Simulated Divided Lites (SDL)
- Scrolled & Flat Advanta Lite Frame  
Not available for 2'4" and 2'6" doors or 10" sidelites.
- Scrolled Advanta Lite Frame  
Not available for 2'4" and 2'6" doors or 10" sidelites.
- Vented Sidelite Options
- E Elevated 10" Bottom Rail Options
- 6 WBDR Options
- 6 WBDR / HVHZ Options
- ⚠ 6'6" Height Available

**PRIVACY & TEXTURED GLASS** *Continued*

				
<b>Mahogany</b>	<b>Mahogany</b>	<b>Oak</b>	<b>Oak</b>	<b>Oak</b>
<b>FCM870_SL</b> 12" x 8'0" 14" x 8'0"	<b>FCM12101_SL</b> 10" x 6'8" 12" x 6'8" (7'0") 14" x 6'8" (7'0")	<b>FCM81200_SL</b> 12" x 8'0" 14" x 8'0"	<b>FC10_</b> 2'8" x 6'8" (7'0") 2'10" x 6'8" (7'0") 3'0" x 6'8" (7'0")	<b>81200P_</b> 2'8" x 8'0" 2'10" x 8'0" 3'0" x 8'0"
<b>1283_</b> 2'8" x 6'8" Δ (7'0") 2'10" x 6'8" Δ (7'0") 3'0" x 6'8" Δ (7'0")	<b>81200_</b> 2'6" x 8'0" 2'10" x 8'0" 3'0" x 8'0"	<b>FC47_SL</b> 10" x 6'8" 12" x 6'8" 14" x 6'8"	<b>81200P_SL</b> 12" x 8'0" 14" x 8'0"	

				
<b>Oak</b>	<b>Smooth</b>	<b>Smooth</b>	<b>Smooth</b>	<b>Smooth</b>
<b>12101_SL</b> 12" x 6'8" Δ (7'0") 14" x 6'8" Δ (7'0")	<b>81200_SL</b> 12" x 8'0" 14" x 8'0"	<b>S118_</b> 2'8" x 6'8" (7'0") 2'10" x 6'8" (7'0") 3'0" x 6'8" (7'0")	<b>S818_</b> 2'8" x 8'0" 2'10" x 8'0" 3'0" x 8'0"	<b>S140_</b> 2'8" x 6'8" Δ (7'0") 2'10" x 6'8" Δ (7'0") 3'0" x 6'8" Δ (7'0") 3'6" x 6'8"
<b>S8140_</b> 2'8" x 8'0" 2'10" x 8'0" 3'0" x 8'0" 3'6" x 8'0"	<b>S100_SL</b> 12" x 6'8" 14" x 6'8"	<b>S8601_SL</b> 12" x 8'0" 14" x 8'0"	<b>S601_SL</b> 10" x 6'8" 12" x 6'8" Δ (7'0") 14" x 6'8" Δ (7'0")	<b>S81086_SL</b> 12" x 8'0" 14" x 8'0"

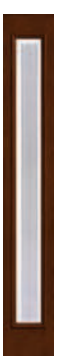
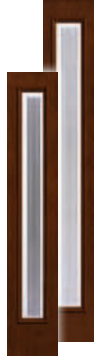
**INTERNAL BLINDS**

				
<b>Mahogany</b>	<b>Mahogany</b>	<b>Mahogany</b>	<b>Mahogany</b>	<b>Oak</b>
<b>FCM141</b> 2'8" x 6'8" 2'10" x 6'8" 3'0" x 6'8"	<b>FCM8115</b> 2'8" x 8'0" 2'10" x 8'0" 3'0" x 8'0"	<b>FCM1286</b> 2'4" x 6'8" 2'6" x 6'8" (7'0") 2'8" x 6'8" (7'0") 2'10" x 6'8" (7'0") 3'0" x 6'8" (7'0")	<b>FCM81225</b> 2'6" x 8'0" 2'8" x 8'0" 2'10" x 8'0" 3'0" x 8'0"	<b>FCM8115SL</b> 12" x 8'0" 14" x 8'0"
<b>FCM1286SL</b> 10" x 6'8" 12" x 6'8" (7'0") 14" x 6'8" (7'0")	<b>FCM81225SL</b> 12" x 8'0" 14" x 8'0"	<b>FC141</b> 2'6" x 6'8" 2'8" x 6'8" (7'0") 2'10" x 6'8" (7'0") 3'0" x 6'8" (7'0")	<b>81225P</b> 2'8" x 8'0" 2'10" x 8'0" 3'0" x 8'0"	

**Privacy & Textured Glass Options**

Add the code to the blank in the style number for the desired door and glass combination. For details on glass options, see page 119.

**XK = Reeded**      **XC = Chord**      **XR = Rainglass**  
**XE = Satin Etch**      **XJ = Chinchilla**      **XN = Granite**





Oak

1286



2'4" x 6'8"  $\Delta$   
 2'6" x 6'8"  $\Delta$  (7'0")  
 2'8" x 6'8"  $\Delta$  (7'0")  
 2'10" x 6'8"  $\Delta$  (7'0")  
 3'0" x 6'8"  $\Delta$  (7'0")



Oak

81225



2'6" x 8'0"  
 2'8" x 8'0"  
 2'10" x 8'0"  
 3'0" x 8'0"

FC141SL



10" x 6'8"  
 12" x 6'8"  
 14" x 6'8"

81225PSL



12" x 8'0"  
 14" x 8'0"



Oak

1286SL



12" x 6'8"  $\Delta$  (7'0")  
 14" x 6'8"  $\Delta$  (7'0")

81225SL



12" x 8'0"  
 14" x 8'0"



Smooth

S130



2'6" x 6'8"  
 2'8" x 6'8" (7'0")  
 2'10" x 6'8" (7'0")  
 3'0" x 6'8" (7'0")

S829



2'6" x 8'0"  
 2'8" x 8'0"  
 2'10" x 8'0"  
 3'0" x 8'0"



Smooth

S6061



2'4" x 6'8"  $\Delta$   
 2'6" x 6'8"  $\Delta$   
 2'8" x 6'8"  $\Delta$  (7'0")  
 2'10" x 6'8"  $\Delta$  (7'0")  
 3'0" x 6'8"  $\Delta$  (7'0")  
 3'6" x 6'8"

S81225



2'6" x 8'0"  
 2'8" x 8'0"  
 2'10" x 8'0"  
 3'0" x 8'0"  
 3'6" x 8'0"



Smooth

S130SL



12" x 6'8"  
 14" x 6'8"

S829SL



12" x 8'0"  
 14" x 8'0"



Smooth

S6128SL



10" x 6'8"  
 12" x 6'8"  $\Delta$  (7'0")  
 14" x 6'8"  $\Delta$  (7'0")

S85928SL



12" x 8'0"  
 14" x 8'0"

### CLEAR GLASS WITH DIVIDED LITES



Mahogany

FCM1209



2'8" x 6'8"  
 2'10" x 6'8"  
 3'0" x 6'8"



Mahogany

FCM1201



2'6" x 6'8" (7'0")  
 2'8" x 6'8" (7'0")  
 2'10" x 6'8" (7'0")  
 3'0" x 6'8" (7'0")



Mahogany

FCM1211



2'8" x 6'8"  
 2'10" x 6'8"  
 3'0" x 6'8"



Mahogany

FCM1202



2'6" x 6'8" (7'0")  
 2'8" x 6'8" (7'0")  
 2'10" x 6'8" (7'0")  
 3'0" x 6'8" (7'0")



Mahogany

FCM1212



2'8" x 6'8"  
 2'10" x 6'8"  
 3'0" x 6'8"



Mahogany

FCM1203



2'6" x 6'8" (7'0")  
 2'8" x 6'8" (7'0")  
 2'10" x 6'8" (7'0")  
 3'0" x 6'8" (7'0")



Mahogany

FCM138



2'8" x 6'8"  
 2'10" x 6'8"  
 3'0" x 6'8"



Mahogany

FCM1285



2'6" x 6'8" (7'0")  
 2'8" x 6'8" (7'0")  
 2'10" x 6'8" (7'0")  
 3'0" x 6'8" (7'0")



Mahogany

FCM1208



2'8" x 6'8"  
 2'10" x 6'8"  
 3'0" x 6'8"



Mahogany

FCM1200



2'6" x 6'8" (7'0")  
 2'8" x 6'8" (7'0")  
 2'10" x 6'8" (7'0")  
 3'0" x 6'8" (7'0")

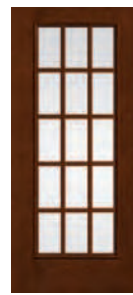

Mahogany

FCM18



2'8" x 6'8"  
 2'10" x 6'8"  
 3'0" x 6'8"

CLEAR GLASS WITH DIVIDED LITES *Continues on next page.*

### Key

No Stile Lines

Low-E Glass (LE)

Simulated Divided Lites (SDL)

Flat or Contour White Grilles Between Glass (GBGF / GBGC)

Flat Almond Grilles Between Glass (GBGF)

Flat Bronze Grilles Between Glass (GBGF)

Flat Lite Frame

Scrolled & Flat Advanta Lite Frame  
 Not available for 2'4" and 2'6" doors or 10" sidelites.

Vented Sidelite Options

WBDR Options

WBDR / HVHZ Options

Elevated 10" Bottom Rail Options

6.6" Height Available

**CLEAR GLASS WITH DIVIDED LITES** *Continued*

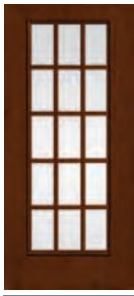

Mahogany

**FCM1284**  
**6E**  
 2'6" x 6'8" (7'0")  
 2'8" x 6'8" (7'0")  
 2'10" x 6'8" (7'0")  
 3'0" x 6'8" (7'0")

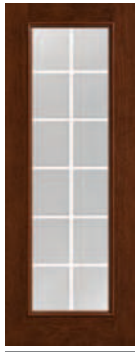

Mahogany

**FCM828**  
**6**  
 2'8" x 8'0"  
 2'10" x 8'0"  
 3'0" x 8'0"



Mahogany

**FCM81828**  
**6**  
 2'6" x 8'0"  
 2'8" x 8'0"  
 2'10" x 8'0"  
 3'0" x 8'0"



Mahogany

**FCM81208P**  
**6**  
 2'8" x 8'0"  
 2'10" x 8'0"  
 3'0" x 8'0"



Mahogany

**FCM81829**  
**6**  
 2'6" x 8'0"  
 2'8" x 8'0"  
 2'10" x 8'0"  
 3'0" x 8'0"



Mahogany

**FCM1201SL**  
**6**  
 10" x 6'8"  
 12" x 6'8" Δ (7'0")  
 14" x 6'8" Δ (7'0")



Mahogany

**FCM1202SL**  
**6**  
 10" x 6'8"  
 12" x 6'8" Δ (7'0")  
 14" x 6'8" Δ (7'0")



Mahogany

**FCM1200SL**  
**6**  
 10" x 6'8"  
 12" x 6'8" Δ (7'0")  
 14" x 6'8" Δ (7'0")



Mahogany

**FCM12102SL**  
**6**  
 10" x 6'8"  
 12" x 6'8" Δ (7'0")  
 14" x 6'8" Δ (7'0")



Mahogany

**FCM81208PSL**  
**6**  
 12" x 8'0"  
 14" x 8'0"



Mahogany

**FCM81208SL**  
**6**  
 12" x 8'0"  
 14" x 8'0"



Mahogany

**FCM6124SL**  
**6**  
 10" x 6'8"  
 12" x 6'8" Δ (7'0")  
 14" x 6'8" Δ (7'0")



Mahogany

**FCM6125SL**  
**6**  
 10" x 6'8"  
 12" x 6'8" Δ (7'0")  
 14" x 6'8" Δ (7'0")



Mahogany

**FCM6126SL**  
**6**  
 10" x 6'8"  
 12" x 6'8" Δ (7'0")  
 14" x 6'8" Δ (7'0")



Mahogany

**FCM198**  
**6**  
 2'8" x 6'8"  
 2'10" x 6'8"  
 3'0" x 6'8"



Mahogany

**FCM1289**  
**6E**  
 2'6" x 6'8" (7'0")  
 2'8" x 6'8" (7'0")  
 2'10" x 6'8" (7'0")  
 3'0" x 6'8" (7'0")



Mahogany

**FCM1289SL**  
**6**  
 10" x 6'8"  
 12" x 6'8" Δ (7'0")  
 14" x 6'8" Δ (7'0")



Oak

**FC1209**  
**E**  
 2'6" x 6'8"  
 2'8" x 6'8" (7'0")  
 2'10" x 6'8" (7'0")  
 3'0" x 6'8" (7'0")



Oak

**FC1201**  
**E**  
 2'6" x 6'8" Δ (7'0")  
 2'8" x 6'8" Δ (7'0")  
 2'10" x 6'8" Δ (7'0")  
 3'0" x 6'8" Δ (7'0")

















Oak

**FC1211**  
**E**  
 2'6" x 6'8"  
 2'8" x 6'8" (7'0")  
 2'10" x 6'8" (7'0")  
 3'0" x 6'8" (7'0")

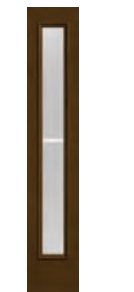

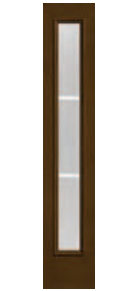

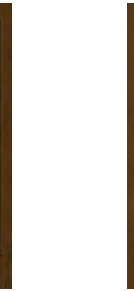









Oak









**FC1202**  
**E**  
 2'6" x 6'8" Δ (7'0")  
 2'8" x 6'8" Δ (7'0")  
 2'10" x 6'8" Δ (7'0")  
 3'0" x 6'8" Δ (7'0")



							
Oak	Oak	Oak	Oak	Oak	Oak	Oak	
FC1212 *♦♦♦♦E 2'6" x 6'8" 2'8" x 6'8" (7'0") 2'10" x 6'8" (7'0") 3'0" x 6'8" (7'0")	FC1203 *♦♦♦♦E 2'6" x 6'8" Δ (7'0") 2'8" x 6'8" Δ (7'0") 2'10" x 6'8" Δ (7'0") 3'0" x 6'8" Δ (7'0")	FC138 *♦♦♦♦E 2'6" x 6'8" 2'8" x 6'8" (7'0") 2'10" x 6'8" (7'0") 3'0" x 6'8" (7'0")	1285 *♦♦♦♦E 2'6" x 6'8" Δ (7'0") 2'8" x 6'8" Δ (7'0") 2'10" x 6'8" Δ (7'0") 3'0" x 6'8" Δ (7'0")	FC1208 *♦♦♦♦E 2'6" x 6'8" 2'8" x 6'8" (7'0") 2'10" x 6'8" (7'0") 3'0" x 6'8" (7'0")	FC1200 *♦♦♦♦E 2'6" x 6'8" Δ (7'0") 2'8" x 6'8" Δ (7'0") 2'10" x 6'8" Δ (7'0") 3'0" x 6'8" Δ (7'0")	FC18 *♦♦♦♦E 2'6" x 6'8" 2'8" x 6'8" (7'0") 2'10" x 6'8" (7'0") 3'0" x 6'8" (7'0")	
							
Oak	Oak	Oak	Oak	Oak	Oak	Oak	
1284 *♦♦♦♦E 2'6" x 6'8" Δ (7'0") 2'8" x 6'8" Δ (7'0") 2'10" x 6'8" Δ (7'0") 3'0" x 6'8" Δ (7'0")	FC828 *♦♦♦♦E 2'6" x 8'0" 2'10" x 8'0" 3'0" x 8'0"	81828 *♦♦♦♦E 2'6" x 8'0" 2'8" x 8'0" 2'10" x 8'0" 3'0" x 8'0"	81208P *♦♦♦♦E 2'6" x 8'0" 2'10" x 8'0" 3'0" x 8'0"	81208 *♦♦♦♦E 2'6" x 8'0" 2'8" x 8'0" 2'10" x 8'0" 3'0" x 8'0"	FC1209SL *♦♦♦♦E 10" x 6'8" 12" x 6'8" 14" x 6'8"	FC1201SL *♦♦♦♦E 12" x 6'8" Δ (7'0") 14" x 6'8" Δ (7'0")	
							
Oak	Oak	Oak	Oak	Oak	Oak	Oak	Oak
FC1211SL *♦♦♦♦E 10" x 6'8" 12" x 6'8" 14" x 6'8"	FC1202SL *♦♦♦♦E 12" x 6'8" Δ (7'0") 14" x 6'8" Δ (7'0")	FC1208SL *♦♦♦♦E 10" x 6'8" 12" x 6'8" 14" x 6'8"	FC1200SL *♦♦♦♦E 12" x 6'8" Δ (7'0") 14" x 6'8" Δ (7'0")	FC18SL *♦♦♦♦E 10" x 6'8" 12" x 6'8" 14" x 6'8"	12102SL *♦♦♦♦E 12" x 6'8" Δ (7'0") 14" x 6'8" Δ (7'0")	81208PSL *♦♦♦♦E 12" x 8'0" 14" x 8'0"	81208SL *♦♦♦♦E 12" x 8'0" 14" x 8'0"







**CLEAR GLASS WITH DIVIDED LITES** *Continues on next page.*













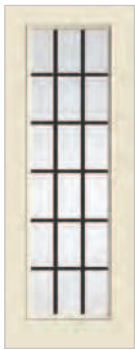









































**Key**

-  No Stile Lines
-  Low-E Glass (LE)
-  Simulated Divided Lites (SDL)
-  Flat or Contour White Grilles Between Glass (GBGF / GBGC)
-  Flat Almond Grilles Between Glass (GBGF)
-  Flat Bronze Grilles Between Glass (GBGF)
-  Scrolled & Flat Advanta Lite Frame  
Not available for 2'4" and 2'6" doors or 10" sidelites.
-  Scrolled Advanta Lite Frame  
Not available for 2'4" and 2'6" doors or 10" sidelites.
-  Vented Sidelite Options
-  WBDR Options
-  WBDR / HVHZ Options
-  Elevated 10" Bottom Rail Options
-  6'6" Height Available

							
Oak	Oak	Oak	Oak	Oak	Oak	Oak	Oak
FC06188SL ☀️🔺🔻🔼🔽 10" x 6'8" 12" x 6'8" 14" x 6'8"	FC06184SL ☀️🔺🔻🔼🔽 12" x 6'8" Δ (7'0") 14" x 6'8" Δ (7'0")	FC06189SL ☀️🔺🔻🔼🔽 10" x 6'8" 12" x 6'8" 14" x 6'8"	FC06185SL ☀️🔺🔻🔼🔽 12" x 6'8" Δ (7'0") 14" x 6'8" Δ (7'0")	FC06190SL ☀️🔺🔻🔼🔽 10" x 6'8" 12" x 6'8" 14" x 6'8"	FC06186SL ☀️🔺🔻🔼🔽 12" x 6'8" Δ (7'0") 14" x 6'8" Δ (7'0")	FC198 ☀️🔺🔻🔼🔽6E 2'6" x 6'8" 2'8" x 6'8" (7'0") 2'10" x 6'8" (7'0") 3'0" x 6'8" (7'0")	1289 ☀️🔺🔻🔼🔽6E 2'6" x 6'8" Δ (7'0") 2'8" x 6'8" Δ (7'0") 2'10" x 6'8" Δ (7'0") 3'0" x 6'8" Δ (7'0")

						
Oak	Oak	Smooth	Smooth	Smooth	Smooth	Smooth
FC198SL ☀️🔺🔻🔼🔽 10" x 6'8" 12" x 6'8" 14" x 6'8"	FC1289SL ☀️🔺🔻🔼🔽 12" x 6'8" Δ (7'0") 14" x 6'8" Δ (7'0")	S1209 ☀️🔺🔻🔼🔽E 2'6" x 6'8" 2'8" x 6'8" (7'0") 2'10" x 6'8" (7'0") 3'0" x 6'8" (7'0")	S1201 ☀️🔺🔻🔼🔽E 2'6" x 6'8" Δ 2'8" x 6'8" Δ (7'0") 2'10" x 6'8" Δ (7'0") 3'0" x 6'8" Δ (7'0") 3'6" x 6'8"	S1211 ☀️🔺🔻🔼🔽E 2'6" x 6'8" 2'8" x 6'8" (7'0") 2'10" x 6'8" (7'0") 3'0" x 6'8" (7'0")	S1202 ☀️🔺🔻🔼🔽E 2'6" x 6'8" Δ 2'8" x 6'8" Δ (7'0") 2'10" x 6'8" Δ (7'0") 3'0" x 6'8" Δ (7'0") 3'6" x 6'8"	S1212 ☀️🔺🔻🔼🔽E 2'6" x 6'8" 2'8" x 6'8" (7'0") 2'10" x 6'8" (7'0") 3'0" x 6'8" (7'0")

						
Smooth	Smooth	Smooth	Smooth	Smooth	Smooth	Smooth
S1203 ☀️🔺🔻🔼🔽E 2'6" x 6'8" Δ 2'8" x 6'8" Δ (7'0") 2'10" x 6'8" Δ (7'0") 3'0" x 6'8" Δ (7'0") 3'6" x 6'8"	S128 ☀️🔺🔻🔼🔽 2'6" x 6'8" 2'8" x 6'8" (7'0") 2'10" x 6'8" (7'0") 3'0" x 6'8" (7'0")	S141 ☀️🔺🔻🔼🔽 2'6" x 6'8" Δ 2'8" x 6'8" Δ (7'0") 2'10" x 6'8" Δ (7'0") 3'0" x 6'8" Δ (7'0") 3'6" x 6'8"	S1208 ☀️🔺🔻🔼🔽6E 2'6" x 6'8" 2'8" x 6'8" (7'0") 2'10" x 6'8" (7'0") 3'0" x 6'8" (7'0")	S1200 ☀️🔺🔻🔼🔽6E 2'6" x 6'8" Δ 2'8" x 6'8" Δ (7'0") 2'10" x 6'8" Δ (7'0") 3'0" x 6'8" Δ (7'0") 3'6" x 6'8"	S108 ☀️🔺🔻🔼🔽 2'6" x 6'8" 2'8" x 6'8" (7'0") 2'10" x 6'8" (7'0") 3'0" x 6'8" (7'0")	S6063 ☀️🔺🔻🔼🔽 2'6" x 6'8" Δ 2'8" x 6'8" Δ (7'0") 2'10" x 6'8" Δ (7'0") 3'0" x 6'8" Δ (7'0") 3'6" x 6'8"

									
Smooth	Smooth	Smooth	Smooth	Smooth	Smooth	Smooth	Smooth		
<b>S828</b>  2'6" x 8'0" 2'8" x 8'0" 2'10" x 8'0" 3'0" x 8'0"	<b>S81828</b>  2'6" x 8'0" 2'8" x 8'0" 2'10" x 8'0" 3'0" x 8'0" 3'6" x 8'0"	<b>S808</b>  2'6" x 8'0" 2'8" x 8'0" 2'10" x 8'0" 3'0" x 8'0"	<b>S81208</b>  2'6" x 8'0" 2'8" x 8'0" 2'10" x 8'0" 3'0" x 8'0" 3'6" x 8'0"	<b>S1209SL</b>  12" x 6'8" 14" x 6'8"	<b>S1201SL</b>  10" x 6'8" 12" x 6'8" Δ (7'0") 14" x 6'8" Δ (7'0")	<b>S1211SL</b>  12" x 6'8" 14" x 6'8"	<b>S1202SL</b>  10" x 6'8" 12" x 6'8" Δ (7'0") 14" x 6'8" Δ (7'0")		
									
Smooth	Smooth	Smooth	Smooth	Smooth	Smooth	Smooth	Smooth	Smooth	Smooth
<b>S1208SL</b>  12" x 6'8" 14" x 6'8"	<b>S1200SL</b>  10" x 6'8" 12" x 6'8" Δ (7'0") 14" x 6'8" Δ (7'0")	<b>S308SL</b>  12" x 6'8" 14" x 6'8"	<b>S1170SL</b>  10" x 6'8" 12" x 6'8" Δ (7'0") 14" x 6'8" Δ (7'0")	<b>S808SL</b>  12" x 8'0" 14" x 8'0"	<b>S81186SL</b>  12" x 8'0" 14" x 8'0"	<b>S605SL</b>  12" x 6'8" 14" x 6'8"	<b>S8605SL</b>  12" x 8'0" 14" x 8'0"	<b>S6124SL</b>  10" x 6'8" 12" x 6'8" Δ (7'0") 14" x 6'8" Δ (7'0")	<b>S85924SL</b>  12" x 8'0" 14" x 8'0"
									
Smooth	Smooth	Smooth	Smooth	Smooth	Smooth	Smooth	Smooth	Smooth	Smooth
<b>S606SL</b>  12" x 6'8" 14" x 6'8"	<b>S8606SL</b>  12" x 8'0" 14" x 8'0"	<b>S6125SL</b>  10" x 6'8" 12" x 6'8" Δ (7'0") 14" x 6'8" Δ (7'0")	<b>S85925SL</b>  12" x 8'0" 14" x 8'0"	<b>S607SL</b>  12" x 6'8" 14" x 6'8"	<b>S8607SL</b>  12" x 8'0" 14" x 8'0"	<b>S6126SL</b>  10" x 6'8" 12" x 6'8" Δ (7'0") 14" x 6'8" Δ (7'0")	<b>S85926SL</b>  12" x 8'0" 14" x 8'0"	<b>S198</b>  2'6" x 6'8" 2'8" x 6'8" (7'0") 2'10" x 6'8" (7'0") 3'0" x 6'8" (7'0")	<b>S6062</b>  2'6" x 6'8" Δ 2'8" x 6'8" Δ (7'0") 2'10" x 6'8" Δ (7'0") 3'0" x 6'8" Δ (7'0") 3'6" x 6'8"

**CLEAR GLASS WITH DIVIDED LITES** *Continues on next page.*

**Key**

-  No Stile Lines
-  Low-E Glass (LE)
-  Simulated Divided Lites (SDL)
-  Flat or Contour White Grilles Between Glass (GBGF / GBGC)
-  Flat Almond Grilles Between Glass (GBGF)
-  Flat Bronze Grilles Between Glass (GBGF)
-  Flat or Contour Black Grilles Between Glass (GBGF / GBGC)
-  Fixed Grilles (FXG)
-  Scrolled & Flat Advanta Lite Frame Not available for 2'4" and 2'6" doors or 10" sidelites.
-  Scrolled Advanta Lite Frame Not available for 2'4" and 2'6" doors or 10" sidelites.
-  Vented Sidelite Options
-  WBDR Options
-  WBDR / HVHZ Options
-  Δ 6'6" Height Available
-  E Elevated 10" Bottom Rail Options

**CLEAR GLASS WITH DIVIDED LITES** *Continued*

**CLEAR GLASS**





Smooth

**S198SL**  
  
 12" x 6'8"  
 14" x 6'8"





Smooth

**S6062SL**  
  
 10" x 6'8"  
 12" x 6'8" Δ (7'0")  
 14" x 6'8" Δ (7'0")



Mahogany

**FCM10**  
  
 2'8" x 6'8"  
 2'10" x 6'8"  
 3'0" x 6'8"

**FCM870**  
  
 2'8" x 8'0"  
 2'10" x 8'0"  
 3'0" x 8'0"



Mahogany

**FCM1283**  
  
 2'4" x 6'8"\*\*\*  
 2'6" x 6'8" (7'0")\*  
 2'8" x 6'8" (7'0")  
 2'10" x 6'8" (7'0")  
 3'0" x 6'8" (7'0")

**FCM81200**  
  
 2'0" x 8'0"\*\*\*  
 2'4" x 8'0"\*\*\*  
 2'6" x 8'0"\*\*\*  
 2'8" x 8'0"  
 2'10" x 8'0"  
 3'0" x 8'0"



Mahogany

**FCM12101SL**  
  
 10" x 6'8"  
 12" x 6'8" (7'0")  
 14" x 6'8" (7'0")

**FCM81200SL**  
  
 12" x 8'0"  
 14" x 8'0"





Mahogany

**FCM870SL**  
  
 12" x 8'0"  
 14" x 8'0"



Oak

**FC10**  
  
 2'6" x 6'8"  
 2'8" x 6'8" (7'0")  
 2'10" x 6'8" (7'0")  
 3'0" x 6'8" (7'0")

**81200P**  
  
 2'8" x 8'0"  
 2'10" x 8'0"  
 3'0" x 8'0"



Oak

**1283**  
  
 2'4" x 6'8" Δ\*  
 2'6" x 6'8" Δ (7'0")\*  
 2'8" x 6'8" Δ (7'0")  
 2'10" x 6'8" Δ (7'0")  
 3'0" x 6'8" Δ (7'0")

**81200**  
  
 2'0" x 8'0"\*\*\*  
 2'4" x 8'0"\*\*\*  
 2'6" x 8'0"\*\*\*  
 2'8" x 8'0"  
 2'10" x 8'0"  
 3'0" x 8'0"



Oak

**FC47SL**  
  
 10" x 6'8"  
 12" x 6'8"  
 14" x 6'8"

**81200PSL**  
  
 12" x 8'0"  
 14" x 8'0"



Oak

**12101SL**  
  
 12" x 6'8" Δ (7'0")  
 12" x 6'8" Δ (7'0")  
 14" x 6'8" Δ (7'0")

**81200SL**  
  
 12" x 8'0"  
 14" x 8'0"





Smooth

**S118**  
  
 2'6" x 6'8"  
 2'8" x 6'8" (7'0")  
 2'10" x 6'8" (7'0")  
 3'0" x 6'8" (7'0")



Smooth

**S818**  
  
 2'6" x 8'0"  
 2'8" x 8'0"  
 2'10" x 8'0"  
 3'0" x 8'0"

**S140**  
  
 2'0" x 6'8"\*\*\*  
 2'4" x 6'8" Δ\*  
 2'6" x 6'8" Δ\*  
 2'8" x 6'8" Δ (7'0")  
 2'10" x 6'8" Δ (7'0")  
 3'0" x 6'8" Δ (7'0")  
 3'6" x 6'8"





Smooth

**S8140**  
  
 2'0" x 8'0"\*\*\*  
 2'4" x 8'0"\*\*\*  
 2'6" x 8'0"\*\*\*  
 2'8" x 8'0"  
 2'10" x 8'0"  
 3'0" x 8'0"  
 3'6" x 8'0"



Smooth

**S100SL**  
  
 12" x 6'8"  
 14" x 6'8"

**S8601SL**  
  
 12" x 8'0"  
 14" x 8'0"



Smooth

**S601SL**  
  
 10" x 6'8"  
 12" x 6'8" Δ (7'0")  
 14" x 6'8" Δ (7'0")

**S81086SL**  
  
 12" x 8'0"  
 14" x 8'0"



Direct Set

**DRS2131SL**  
  
 12" x 6'8" (7'0")  
 14" x 6'8" (7'0")

**DRS82131SL**  
  
 12" x 8'0"  
 14" x 8'0"

\*Available with Impact-rated lite frame only.  
 Note: See page 285 for important product details that may help with your purchase decision.

# 3/4 Lites



## TRANSOMS

For transoms, see page 209.

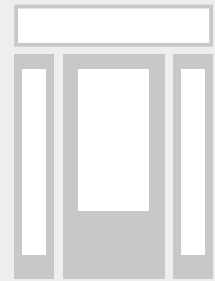

## BLACKSTONE. ◆ ◆

<b>Mahogany</b>	<b>Mahogany</b>	<b>Oak</b>	<b>Oak</b>	<b>Oak</b>	<b>Smooth</b>
<b>FCM765</b> 6 2'8" x 6'8" 2'10" x 6'8" 3'0" x 6'8"	<b>FCM765SL</b> 6 12" x 6'8" 14" x 6'8"	<b>FCM882SL</b> 6 12" x 8'0" 14" x 8'0"	<b>FC765</b> 6 2'8" x 6'8" 2'10" x 6'8" 3'0" x 6'8"	<b>FC770</b> 6 2'8" x 6'8" 2'10" x 6'8" 3'0" x 6'8"	<b>81952P</b> 6 2'8" x 8'0" 2'10" x 8'0" 3'0" x 8'0"
<b>FC765SL</b> 6 12" x 6'8" 14" x 6'8"	<b>81952PSL</b> 6 12" x 8'0" 14" x 8'0"	<b>S975</b> 6 2'8" x 6'8" 2'10" x 6'8" 3'0" x 6'8"			

## CRYSTALLINE™ ◆ ◆

<b>Smooth</b>	<b>Smooth</b>	<b>Mahogany</b>	<b>Mahogany</b>	<b>Oak</b>	<b>Oak</b>
<b>S979</b> 6 2'8" x 6'8" 2'10" x 6'8" 3'0" x 6'8"	<b>S894</b> 6 2'8" x 8'0" 2'10" x 8'0" 3'0" x 8'0"	<b>S975SL</b> 6 12" x 6'8" 14" x 6'8"	<b>S894SL</b> 6 12" x 8'0" 14" x 8'0"	<b>FCM38</b> 6 2'8" x 6'8" 2'10" x 6'8" 3'0" x 6'8"	<b>FCM38SL</b> 6 12" x 6'8" 14" x 6'8"
<b>FCM8105SL</b> 6 12" x 8'0" 14" x 8'0"	<b>FC38</b> 6 2'8" x 6'8" 2'10" x 6'8" 3'0" x 6'8"	<b>FCM8105SL</b> 6 12" x 8'0" 14" x 8'0"	<b>FC772</b> 6 2'8" x 6'8" 2'10" x 6'8" 3'0" x 6'8"	<b>81953P</b> 6 2'8" x 8'0" 2'10" x 8'0" 3'0" x 8'0"	

**CRYSTALLINE** Continues on next page.

### Key

- |                          |   |   |   |                                  |
|--------------------------|---|---|---|----------------------------------|
| No Stile Lines           | Brushed Nickel Caming (1C)                                | Flat Bronze Grilles Between Glass (GBGF)                  | Scrolled & Flat Advanta Lite Frame<br>Not available for 2'4" and 2'6" doors or 10" sidelites. | WBDR / HVHZ Options              |
| Low-E Glass (LE)         | Flat or Contour White Grilles Between Glass (GBGF / GBGC) | Flat or Contour Black Grilles Between Glass (GBGF / GBGC) | Vented Sidelite Options   | Elevated 10" Bottom Rail Options |
| Turtle Glass             | Flat Almond Grilles Between Glass (GBGF)                  | Flat Lite Frame   | WBDR Options  | 6'6" Height Available            |
| Black Nickel Caming (1D) |   |   |   |                                  |

**CRYSTALLINE™** ♦ ■ ■ Continued



Oak

FC38SL | 81953PSL  
 12" x 6'8" | 12" x 8'0"  
 14" x 6'8" | 14" x 8'0"



Smooth

S977  
 2'8" x 6'8"  
 2'10" x 6'8"  
 3'0" x 6'8"



Smooth

S981 | S888  
 2'8" x 6'8" | 2'8" x 8'0"  
 2'10" x 6'8" | 2'10" x 8'0"  
 3'0" x 6'8" | 3'0" x 8'0"



Smooth

S758SL | S888SL  
 12" x 6'8" | 12" x 8'0"  
 14" x 6'8" | 14" x 8'0"



Mahogany

FCM131  
 2'8" x 6'8"  
 2'10" x 6'8"  
 3'0" x 6'8"



Mahogany

FCM131SL | FCM883SL  
 12" x 6'8" | 12" x 8'0"  
 14" x 6'8" | 14" x 8'0"



Oak

FC131  
 2'8" x 6'8"  
 2'10" x 6'8"  
 3'0" x 6'8"



Oak

FC773 | 81954P  
 2'8" x 6'8" | 2'8" x 8'0"  
 2'10" x 6'8" | 2'10" x 8'0"  
 3'0" x 6'8" | 3'0" x 8'0"



Oak

FC131SL | 81954PSL  
 12" x 6'8" | 12" x 8'0"  
 14" x 6'8" | 14" x 8'0"



Smooth

S95  
 2'8" x 6'8"  
 2'10" x 6'8"  
 3'0" x 6'8"



Smooth

S91 | S887  
 2'8" x 6'8" | 2'8" x 8'0"  
 2'10" x 6'8" | 2'10" x 8'0"  
 3'0" x 6'8" | 3'0" x 8'0"



Smooth

S91SL | S887SL  
 12" x 6'8" | 12" x 8'0"  
 14" x 6'8" | 14" x 8'0"

**SALINAS. X**



Mahogany

FCM115  
 2'8" x 6'8"  
 2'10" x 6'8"  
 3'0" x 6'8"



Mahogany

FCM115SL | FCM884SL  
 12" x 6'8" | 12" x 8'0"  
 14" x 6'8" | 14" x 8'0"



Oak

FC115  
 2'8" x 6'8"  
 2'10" x 6'8"  
 3'0" x 6'8"



Oak

FC775 | 81955P  
 2'8" x 6'8" | 2'8" x 8'0"  
 2'10" x 6'8" | 2'10" x 8'0"  
 3'0" x 6'8" | 3'0" x 8'0"



Oak

FC115SL | 81955PSL  
 12" x 6'8" | 12" x 8'0"  
 14" x 6'8" | 14" x 8'0"



Smooth

S6009  
 2'8" x 6'8"  
 2'10" x 6'8"  
 3'0" x 6'8"



### MAPLE PARK. ◆ ■



Smooth

S6010

2'8" x 6'8"  
2'10" x 6'8"  
3'0" x 6'8"



Smooth

S895

2'8" x 8'0"  
2'10" x 8'0"  
3'0" x 8'0"

S6009SL

12" x 6'8"  
14" x 6'8"

S895SL

12" x 8'0"  
14" x 8'0"



Mahogany

FCM902

2'8" x 6'8"  
2'10" x 6'8"  
3'0" x 6'8"



Mahogany

FCM902SL

12" x 6'8"  
14" x 6'8"

FCM887SL

12" x 8'0"  
14" x 8'0"



Oak

FC902

2'8" x 6'8"  
2'10" x 6'8"  
3'0" x 6'8"



Oak

FC777

2'8" x 6'8"  
2'10" x 6'8"  
3'0" x 6'8"

81957P

2'8" x 8'0"  
2'10" x 8'0"  
3'0" x 8'0"

### SARATOGA. ◆ ■



Oak

FC902SL

12" x 6'8"  
14" x 6'8"

81957PSL

12" x 8'0"  
14" x 8'0"

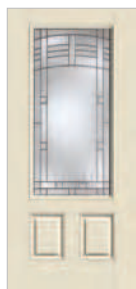

Smooth

S6102

2'8" x 6'8"  
2'10" x 6'8"  
3'0" x 6'8"



Smooth

S6103

2'8" x 6'8"  
2'10" x 6'8"  
3'0" x 6'8"

S85898

2'8" x 8'0"  
2'10" x 8'0"  
3'0" x 8'0"



Smooth

S6102SL

12" x 6'8"  
14" x 6'8"

S85898SL

12" x 8'0"  
14" x 8'0"



Mahogany

FCM907

2'8" x 6'8"  
2'10" x 6'8"  
3'0" x 6'8"



Mahogany

FCM907SL

12" x 6'8"  
14" x 6'8"

FCM889SL

12" x 8'0"  
14" x 8'0"



Oak

FC907

2'8" x 6'8"  
2'10" x 6'8"  
3'0" x 6'8"



Oak

FC776

2'8" x 6'8"  
2'10" x 6'8"  
3'0" x 6'8"

81956P

2'8" x 8'0"  
2'10" x 8'0"  
3'0" x 8'0"



Oak

FC907SL

12" x 6'8"  
14" x 6'8"

81956PSL

12" x 8'0"  
14" x 8'0"



Smooth

S6092

2'8" x 6'8"  
2'10" x 6'8"  
3'0" x 6'8"



Smooth

S982

2'8" x 6'8"  
2'10" x 6'8"  
3'0" x 6'8"

S891

2'8" x 8'0"  
2'10" x 8'0"  
3'0" x 8'0"

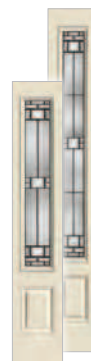

Smooth

S6092SL

12" x 6'8"  
14" x 6'8"







S891SL

12" x 8'0"  
14" x 8'0"





#### Key

- ◆ Black Nickel Caming (1D)
- Brushed Nickel Caming (1C)
- ✗ Wrought Iron (1W)
- └ Flat Lite Frame
- ▬ Scrolled & Flat Advanta Lite Frame  
Not available for 2'4" and 2'6" doors or 10" sidelites.
- 6 WBDR Options
- 8 WBDR / HVHZ Options



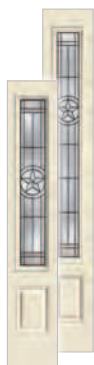

**TEXAS STAR** ◆ ◆

					
Mahogany	Mahogany	Oak	Oak	Oak	Smooth
FCM143 2'8" x 6'8" 2'10" x 6'8" 3'0" x 6'8"	FCM143SL 12" x 6'8" 14" x 6'8"	FCM8103SL 12" x 8'0" 14" x 8'0"	FC143 2'8" x 6'8" 2'10" x 6'8" 3'0" x 6'8"	FC778 2'8" x 6'8" 2'10" x 6'8" 3'0" x 6'8"	81958P 2'8" x 8'0" 2'10" x 8'0" 3'0" x 8'0"
FC143SL 12" x 6'8" 14" x 6'8"	81958PSL 12" x 8'0" 14" x 8'0"	S6071 2'8" x 6'8" 2'10" x 6'8" 3'0" x 6'8"			

**WELLESLEY** ◆ ◆ ◆

					
Smooth	Smooth	Mahogany	Mahogany	Oak	Oak
S6072 2'8" x 6'8" 2'10" x 6'8" 3'0" x 6'8"	S85901 2'8" x 8'0" 2'10" x 8'0" 3'0" x 8'0"	FCM147 2'8" x 6'8" 2'10" x 6'8" 3'0" x 6'8"	FCM147SL 12" x 6'8" 14" x 6'8"	FCM885SL 12" x 8'0" 14" x 8'0"	FC147 2'8" x 6'8" 2'10" x 6'8" 3'0" x 6'8"
S6071SL 12" x 6'8" 14" x 6'8"	85901SL 12" x 8'0" 14" x 8'0"	FC779 2'8" x 6'8" 2'10" x 6'8" 3'0" x 6'8"	FCM885SL 12" x 8'0" 14" x 8'0"	81959P 2'8" x 8'0" 2'10" x 8'0" 3'0" x 8'0"	

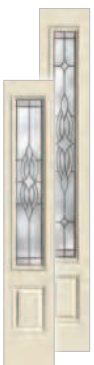
**RISERVA** X

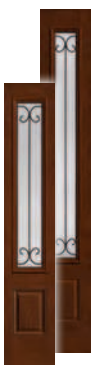
					
Oak	Smooth	Smooth	Smooth	Mahogany	Mahogany
FC147SL 12" x 6'8" 14" x 6'8"	81959PSL 12" x 8'0" 14" x 8'0"	S6091 2'8" x 6'8" 2'10" x 6'8" 3'0" x 6'8"	S983 2'8" x 6'8" 2'10" x 6'8" 3'0" x 6'8"	S892 2'8" x 8'0" 2'10" x 8'0" 3'0" x 8'0"	S6091SL 12" x 6'8" 14" x 6'8"
S892SL 12" x 8'0" 14" x 8'0"	S6091SL 12" x 6'8" 14" x 6'8"	S892SL 12" x 8'0" 14" x 8'0"	FCM543 2'8" x 6'8" 2'10" x 6'8" 3'0" x 6'8"	FCM545SL 12" x 6'8" 14" x 6'8"	FCM8545SL 12" x 8'0" 14" x 8'0"



**CONCORDE™** ◆ ◆ ◆

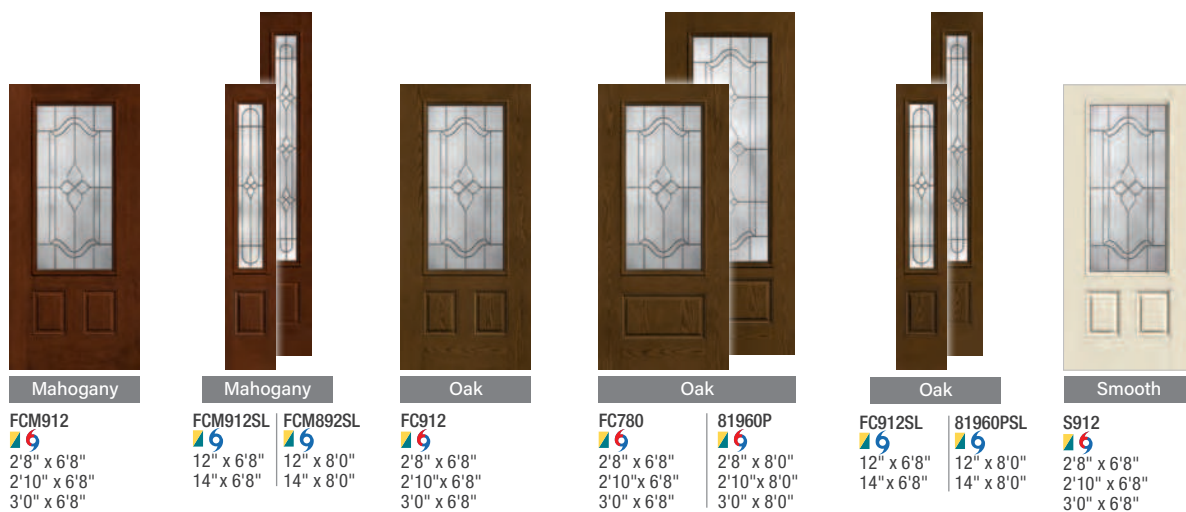

**KENSINGTON™** ◆ ◆ ◆

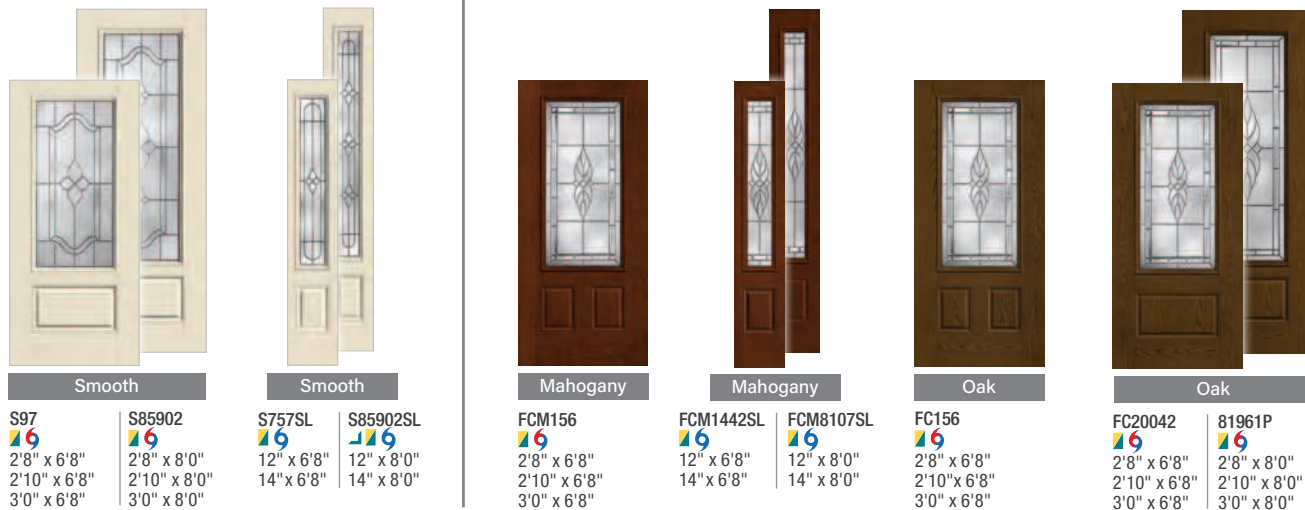

**KENSINGTON** Continues on next page.

**Key**

- ◆ Black Nickel Caming (1D)
- ◆ Brushed Nickel Caming (1C)
- ◆ Brass Caming (1A)
- ✗ Wrought Iron (1W)
- ▽ Flat Lite Frame
- ▽ Scrolled & Flat Advanta Lite Frame  
Not available for 2'4" and 2'6" doors or 10" sidelites.
- 6 WBDP Options
- 6 WBDP / HVHZ Options

**KENSINGTON™** ◆ ■ ■ Continued

**PEMBRIDGE™** ◆ ■ ■ ◆



**Oak**

<b>FC1442SL</b> 2'6"	<b>81961PSL</b> 2'6"
12" x 6'8"	12" x 8'0"
14" x 6'8"	14" x 8'0"



**Smooth**

<b>S20042</b> 2'6"	<b>S902</b> 2'6"
2'8" x 6'8"	2'8" x 8'0"
2'10" x 6'8"	2'10" x 8'0"
3'0" x 6'8"	3'0" x 8'0"



**Smooth**

<b>S156</b> 2'6"
2'8" x 6'8"
2'10" x 6'8"
3'0" x 6'8"



**Smooth**

<b>S1442SL</b> 2'6"	<b>S902SL</b> 2'6"
12" x 6'8"	12" x 8'0"
14" x 6'8"	14" x 8'0"



**Mahogany**

<b>FCM6582</b> 2'6"
2'8" x 6'8"
2'10" x 6'8"
3'0" x 6'8"



**Mahogany**

<b>FCM6580SL</b> 2'6"	<b>FCM86580SL</b> 2'6"
12" x 6'8"	12" x 8'0"
14" x 6'8"	14" x 8'0"



**Oak**

<b>FC6582</b> 2'6"
2'8" x 6'8"
2'10" x 6'8"
3'0" x 6'8"



**Oak**

<b>FC6580</b> 2'6"	<b>FC86580</b> 2'6"
2'8" x 6'8"	2'8" x 8'0"
2'10" x 6'8"	2'10" x 8'0"
3'0" x 6'8"	3'0" x 8'0"



**Oak**

<b>FC6580SL</b> 2'6"	<b>FC86580SL</b> 2'6"
12" x 6'8"	12" x 8'0"
14" x 6'8"	14" x 8'0"



**Smooth**

<b>S6582</b> 2'6"
2'8" x 6'8"
2'10" x 6'8"
3'0" x 6'8"



**Smooth**

<b>S6580</b> 2'6"	<b>S86580</b> 2'6"
2'8" x 6'8"	2'8" x 8'0"
2'10" x 6'8"	2'10" x 8'0"
3'0" x 6'8"	3'0" x 8'0"



**Smooth**

<b>S6580SL</b> 2'6"	<b>S86580SL</b> 2'6"
12" x 6'8"	12" x 8'0"
14" x 6'8"	14" x 8'0"

**AXIS™** ◆



**Mahogany**

<b>FC1647</b> 2'6"
2'8" x 6'8"
2'10" x 6'8"
3'0" x 6'8"



**Mahogany**

<b>FCM1646SL</b> 2'6"	<b>FCM81646SL</b> 2'6"
12" x 6'8"	12" x 8'0"
14" x 6'8"	14" x 8'0"



**Oak**

<b>FC1647</b> 2'6"
2'8" x 6'8"
2'10" x 6'8"
3'0" x 6'8"



**Oak**

<b>FC1646</b> 2'6"	<b>FC81646</b> 2'6"
2'8" x 6'8"	2'8" x 8'0"
2'10" x 6'8"	2'10" x 8'0"
3'0" x 6'8"	3'0" x 8'0"



**Oak**

<b>FC1646SL</b> 2'6"	<b>FC81646SL</b> 2'6"
12" x 6'8"	12" x 8'0"
14" x 6'8"	14" x 8'0"



**Smooth**

<b>S1647</b> 2'6"
2'8" x 6'8"
2'10" x 6'8"
3'0" x 6'8"

CALIX ◆ ◆ ◆ ◆



Smooth

S1646

2'8" x 6'8"  
2'10" x 6'8"  
3'0" x 6'8"

S81646

2'8" x 8'0"  
2'10" x 8'0"  
3'0" x 8'0"



Smooth

S1646SL

12" x 6'8"  
14" x 6'8"

S81646SL

12" x 8'0"  
14" x 8'0"



Mahogany

FCM389

2'8" x 6'8"  
2'10" x 6'8"  
3'0" x 6'8"



Mahogany

FCM4521SL

12" x 6'8"  
14" x 6'8"

FCM84521SL

12" x 8'0"  
14" x 8'0"



Oak

FC389

2'8" x 6'8"  
2'10" x 6'8"  
3'0" x 6'8"



Oak

FC4521

2'8" x 6'8"  
2'10" x 6'8"  
3'0" x 6'8"

FC84521

2'8" x 8'0"  
2'10" x 8'0"  
3'0" x 8'0"

LATITUDE ◆ ◆ ◆ ◆



Oak

FC4521SL

12" x 6'8"  
14" x 6'8"

FC84521SL

12" x 8'0"  
14" x 8'0"



Smooth

S389

2'8" x 6'8"  
2'10" x 6'8"  
3'0" x 6'8"

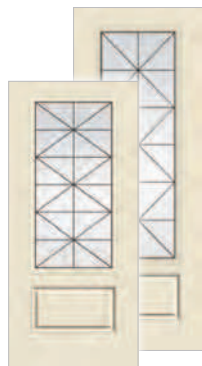

Smooth

S4521

2'8" x 6'8"  
2'10" x 6'8"  
3'0" x 6'8"

S84521

2'8" x 8'0"  
2'10" x 8'0"  
3'0" x 8'0"

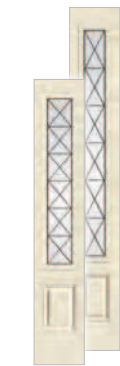

Smooth

S4521SL

12" x 6'8"  
14" x 6'8"

S84521SL

12" x 8'0"  
14" x 8'0"



Mahogany

FCM476

2'8" x 6'8"  
2'10" x 6'8"  
3'0" x 6'8"



Mahogany

FCM4525SL

12" x 6'8"  
14" x 6'8"

FCM84525SL

12" x 8'0"  
14" x 8'0"



Oak

FC476

2'8" x 6'8"  
2'10" x 6'8"  
3'0" x 6'8"



Oak

FC4525

2'8" x 6'8"  
2'10" x 6'8"  
3'0" x 6'8"

FC84525

2'8" x 8'0"  
2'10" x 8'0"  
3'0" x 8'0"



Oak

FC4525SL

12" x 6'8"  
14" x 6'8"

FC84525SL

12" x 8'0"  
14" x 8'0"



Smooth

S476

2'8" x 6'8"  
2'10" x 6'8"  
3'0" x 6'8"



Smooth

S4525

2'8" x 6'8"  
2'10" x 6'8"  
3'0" x 6'8"

S84525

2'8" x 8'0"  
2'10" x 8'0"  
3'0" x 8'0"

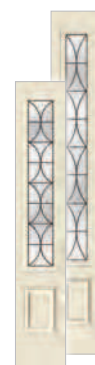

Smooth

S4525SL

12" x 6'8"  
14" x 6'8"

S84525SL

12" x 8'0"  
14" x 8'0"

Key

- ◆ Black Nickel Caming (1D)
- ◆◆ Brushed Nickel Caming (1C)
- ◆◆ Brass Caming (1A)
- └ Flat Lite Frame

- ▒ Scrolled & Flat Advanta Lite Frame  
Not available for 2'4" and 2'6" doors or 10" sidelites.
- └ WBDR Options

- └ WBDR / HVHZ Options

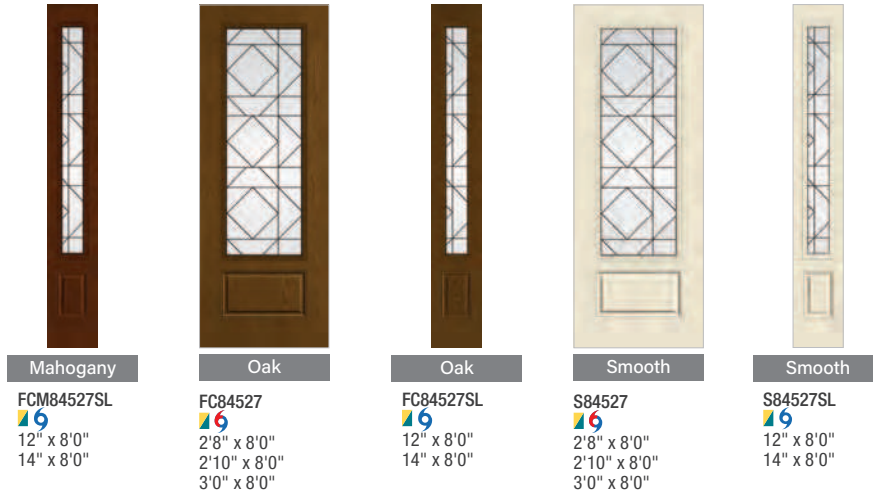







**PRIVACY & TEXTURED GLASS WITH DIVIDED LITES**



**Privacy & Textured Glass Options**  
 Add the code to the blank in the style number for the desired door and glass combination. For details on glass options, see page 119.

XK = Reeded	XC = Chord	XR = Rainglass
XE = Satin Etch	XJ = Chinchilla	XN = Granite

## PRIVACY & TEXTURED GLASS

					
<b>Smooth</b>	<b>Smooth</b>	<b>Mahogany</b>	<b>Mahogany</b>	<b>Oak</b>	<b>Oak</b>
S82_SL 12" x 6'8" 14" x 6'8"	S881_SL 12" x 8'0" 14" x 8'0"	FCM32_ 2'8" x 6'8" 2'10" x 6'8" 3'0" x 6'8"	FCM32_SL   FCM881_SL 12" x 6'8"   12" x 8'0" 14" x 6'8"   14" x 8'0"	FC32_ 2'8" x 6'8" 2'10" x 6'8" 3'0" x 6'8"	FC766_   81943P_ 2'8" x 6'8"   2'8" x 8'0" 2'10" x 6'8"   2'10" x 8'0" 3'0" x 6'8"   3'0" x 8'0"

## INTERNAL BLINDS

					
<b>Oak</b>	<b>Smooth</b>	<b>Smooth</b>	<b>Smooth</b>	<b>Mahogany</b>	<b>Mahogany</b>
FC32_SL   81943P_SL 12" x 6'8"   12" x 8'0" 14" x 6'8"   14" x 8'0"	S80_ 2'8" x 6'8" 2'10" x 6'8" 3'0" x 6'8"	S90_ 2'8" x 6'8" 2'10" x 6'8" 3'0" x 6'8"	S880_ 2'8" x 8'0" 2'10" x 8'0" 3'0" x 8'0"	S751_SL   S880_SL 12" x 6'8"   12" x 8'0" 14" x 6'8"   14" x 8'0"	FCM5425   FCM5425SL   FCM8110SL 2'8" x 6'8"   12" x 6'8"   12" x 8'0" 2'10" x 6'8"   14" x 6'8"   14" x 8'0" 3'0" x 6'8"   14" x 6'8"   14" x 8'0"

					
<b>Oak</b>	<b>Oak</b>	<b>Oak</b>	<b>Smooth</b>	<b>Smooth</b>	<b>Smooth</b>
FC5425 2'8" x 6'8" 2'10" x 6'8" 3'0" x 6'8"	1964P   81964P 2'8" x 6'8"   2'8" x 8'0" 2'10" x 6'8"   2'10" x 8'0" 3'0" x 6'8"   3'0" x 8'0"	FC5425SL   81964PSL 12" x 6'8"   12" x 8'0" 14" x 6'8"   14" x 8'0"	S5425 2'8" x 6'8" 2'10" x 6'8" 3'0" x 6'8"	S682   S8682 2'8" x 6'8"   2'8" x 8'0" 2'10" x 6'8"   2'10" x 8'0" 3'0" x 6'8"   3'0" x 8'0"	S5425SL   S8682SL 12" x 6'8"   12" x 8'0" 14" x 6'8"   14" x 8'0"

### Key

-  Low-E Glass (LE)
-  Simulated Divided Lites (SDL)
-  Flat Lite Frame
-  Scrolled & Flat Advanta Lite Frame  
Not available for 2'4" and 2'6" doors or 10" sidelites.
-  Scrolled Advanta Lite Frame  
Not available for 2'4" and 2'6" doors or 10" sidelites.
-  WBDR Options
-  WBDR / HVHZ Options

CLEAR GLASS WITH DIVIDED LITES



Mahogany

FCM2106  
 \* \* \* \* \*  
 2'8" x 6'8"  
 2'10" x 6'8"  
 3'0" x 6'8"



Mahogany

FCM2107  
 \* \* \* \* \* 6  
 2'8" x 6'8"  
 2'10" x 6'8"  
 3'0" x 6'8"



Mahogany

FCM2108  
 \* \* \* \* \*  
 2'8" x 6'8"  
 2'10" x 6'8"  
 3'0" x 6'8"



Mahogany

FCM82  
 \* \* \* \* \* 6  
 2'8" x 6'8"  
 2'10" x 6'8"  
 3'0" x 6'8"



Mahogany

FCM1089SL  
 \* \* \* \* \*  
 12" x 6'8"  
 14" x 6'8"



Mahogany

FCM8311SL  
 \* \* \* \* \*  
 12" x 8'0"  
 14" x 8'0"

FCM2101SL  
 \* \* \* \* \* 6  
 12" x 6'8"  
 14" x 6'8"

FCM8313SL  
 \* \* \* \* \*  
 12" x 8'0"  
 14" x 8'0"



Mahogany

FCM92SL  
 \* \* \* \* \* 6  
 12" x 6'8"  
 14" x 6'8"

FCM8310SL  
 \* \* \* \* \* 6  
 12" x 8'0"  
 14" x 8'0"



Mahogany

FCM8101SL  
 \* \* \* \* \* 6  
 12" x 8'0"  
 14" x 8'0"



Mahogany

FCM81900SL  
 \* \* \* \* \*  
 12" x 8'0"  
 14" x 8'0"



Mahogany

FCM81947SL  
 \* \* \* \* \*  
 12" x 8'0"  
 14" x 8'0"



Mahogany

FCM81949SL  
 \* \* \* \* \*  
 12" x 8'0"  
 14" x 8'0"



Mahogany

FCM1402  
 \* \* \* \* \*  
 2'8" x 6'8"  
 2'10" x 6'8"  
 3'0" x 6'8"



Mahogany

FCM1400SL  
 \* \* \* \* \*  
 12" x 6'8"  
 14" x 6'8"

FCM81944SL  
 \* \* \* \* \*  
 12" x 8'0"  
 14" x 8'0"



Oak

FC2106  
 \* \* \* \* \*  
 2'8" x 6'8"  
 2'10" x 6'8"  
 3'0" x 6'8"



Oak

FC2107  
 \* \* \* \* \* 6  
 2'8" x 6'8"  
 2'10" x 6'8"  
 3'0" x 6'8"



Oak

FC2108  
 \* \* \* \* \*  
 2'8" x 6'8"  
 2'10" x 6'8"  
 3'0" x 6'8"



Oak

FC82  
 \* \* \* \* \* 6  
 2'8" x 6'8"  
 2'10" x 6'8"  
 3'0" x 6'8"



Oak

FC1089  
 \* \* \* \* \*  
 2'8" x 6'8"  
 2'10" x 6'8"  
 3'0" x 6'8"

FC8311  
 \* \* \* \* \*  
 2'8" x 8'0"  
 2'10" x 8'0"  
 3'0" x 8'0"



Oak

FC2101  
 \* \* \* \* \* 6  
 2'8" x 6'8"  
 2'10" x 6'8"  
 3'0" x 6'8"

FC8313  
 \* \* \* \* \*  
 2'8" x 8'0"  
 2'10" x 8'0"  
 3'0" x 8'0"





Oak

FC2102  
 \* ♦ ♦ ♦ ♦  
 2'8" x 6'8"  
 2'10" x 6'8"  
 3'0" x 6'8"



Oak

81945P  
 \* ♦ ♦ ♦ ♦ ♦  
 2'8" x 8'0"  
 2'10" x 8'0"  
 3'0" x 8'0"



Oak

FC92  
 \* ♦ ♦ ♦ ♦ ♦  
 2'8" x 6'8"  
 2'10" x 6'8"  
 3'0" x 6'8"



Oak

81946P  
 \* ♦ ♦ ♦ ♦ ♦  
 2'8" x 8'0"  
 2'10" x 8'0"  
 3'0" x 8'0"



Oak

FC1089SL  
 \* ♦ ♦ ♦ ♦ ♦  
 12" x 6'8"  
 14" x 6'8"

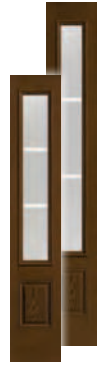

Oak

FC8313SL  
 \* ♦ ♦ ♦ ♦ ♦  
 12" x 8'0"  
 14" x 8'0"



Oak

FC92SL  
 \* ♦ ♦ ♦ ♦ ♦  
 12" x 6'8"  
 14" x 6'8"



Oak

81946PSL  
 \* ♦ ♦ ♦ ♦ ♦  
 12" x 8'0"  
 14" x 8'0"



Oak

81900PSL  
 \* ♦ ♦ ♦ ♦ ♦  
 12" x 8'0"  
 14" x 8'0"



Oak

81947PSL  
 \* ♦ ♦ ♦ ♦ ♦  
 12" x 8'0"  
 14" x 8'0"



Oak

81949PSL  
 \* ♦ ♦ ♦ ♦ ♦  
 12" x 8'0"  
 14" x 8'0"



Oak

FC1402  
 \* ♦ ♦ ♦ ♦ ♦  
 2'8" x 6'8"  
 2'10" x 6'8"  
 3'0" x 6'8"



Oak

FC1400  
 \* ♦ ♦ ♦ ♦ ♦  
 2'8" x 6'8"  
 2'10" x 6'8"  
 3'0" x 6'8"

81944P  
 \* ♦ ♦ ♦ ♦ ♦  
 2'8" x 8'0"  
 2'10" x 8'0"  
 3'0" x 8'0"

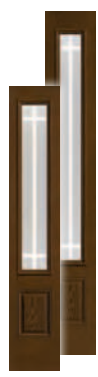

Oak

FC1400SL  
 \* ♦ ♦ ♦ ♦ ♦  
 12" x 6'8"  
 14" x 6'8"



Smooth

S2106  
 \* ♦ ♦ ♦ ♦ ♦  
 2'8" x 6'8"  
 2'10" x 6'8"  
 3'0" x 6'8"



Smooth

S2107  
 \* ♦ ♦ ♦ ♦ ♦  
 2'8" x 6'8"  
 2'10" x 6'8"  
 3'0" x 6'8"



Smooth

S2108  
 \* ♦ ♦ ♦ ♦ ♦  
 2'8" x 6'8"  
 2'10" x 6'8"  
 3'0" x 6'8"



Smooth

S82  
 \* ♦ ♦ ♦ ♦ ♦  
 2'8" x 6'8"  
 2'10" x 6'8"  
 3'0" x 6'8"



Smooth

S1089  
 \* ♦ ♦ ♦ ♦ ♦  
 2'8" x 6'8"  
 2'10" x 6'8"  
 3'0" x 6'8"

S8311  
 \* ♦ ♦ ♦ ♦ ♦  
 2'8" x 8'0"  
 2'10" x 8'0"  
 3'0" x 8'0"

CLEAR GLASS WITH DIVIDED LITES *Continues on next page.*

**Key**

- Low-E Glass (LE)
- Simulated Divided Lites (SDL)
- Flat or Contour White Grilles Between Glass (GBGF / GBGC)
- Flat Almond Grilles Between Glass (GBGF)
- Flat Bronze Grilles Between Glass (GBGF)
- Flat or Contour Black Grilles Between Glass (GBGF / GBGC)
- Scrolled Advanta Lite Frame Not available for 2'4" and 2'6" doors or 10" sidelites.
- Scrolled & Flat Advanta Lite Frame Not available for 2'4" and 2'6" doors or 10" sidelites.
- WBDL Options
- WBDL / HVHZ Options

**CLEAR GLASS WITH DIVIDED LITES** *Continued*

Smooth	Smooth	Smooth	Smooth	Smooth	Smooth	Smooth	Smooth
S2101 ★♦♦♦♦6 2'8" x 6'8" 2'10" x 6'8" 3'0" x 6'8"	S8313 ★♦♦♦♦6 2'8" x 8'0" 2'10" x 8'0" 3'0" x 8'0"	S2102 ★♦♦♦♦6 2'8" x 6'8" 2'10" x 6'8" 3'0" x 6'8"	S8316 ★♦♦♦♦6 2'8" x 8'0" 2'10" x 8'0" 3'0" x 8'0"	S881 ★♦♦♦♦6 2'8" x 8'0" 2'10" x 8'0" 3'0" x 8'0"	S92 ★♦♦♦♦6 2'8" x 6'8" 2'10" x 6'8" 3'0" x 6'8"	S8310 ★♦♦♦♦6 2'8" x 8'0" 2'10" x 8'0" 3'0" x 8'0"	S882 ★♦♦♦♦6 2'8" x 8'0" 2'10" x 8'0" 3'0" x 8'0"

Smooth	Smooth	Smooth	Smooth	Smooth	Smooth	Smooth	Smooth	Smooth	Smooth
S1089SL ★♦♦♦♦6 12" x 6'8" 14" x 6'8"	S8311SL ★♦♦♦♦6 12" x 8'0" 14" x 8'0"	S2101SL ★♦♦♦♦6 12" x 6'8" 14" x 6'8"	S8313SL ★♦♦♦♦6 12" x 8'0" 14" x 8'0"	S82SL ★♦♦♦♦6 12" x 6'8" 14" x 6'8"	S8310SL ★♦♦♦♦6 12" x 8'0" 14" x 8'0"	S881SL ★♦♦♦♦6 12" x 8'0" 14" x 8'0"	S8207SL ★♦♦♦♦6 12" x 8'0" 14" x 8'0"	S8202SL ★♦♦♦♦6 12" x 8'0" 14" x 8'0"	S8204SL ★♦♦♦♦6 12" x 8'0" 14" x 8'0"

Smooth	Smooth	Smooth	Smooth	Smooth
S1402 ★♦♦♦♦6 2'8" x 6'8" 2'10" x 6'8" 3'0" x 6'8"	S1400 ★♦♦♦♦6 2'8" x 8'0" 2'10" x 6'8" 3'0" x 6'8"	S898 ★♦♦♦♦6 2'8" x 8'0" 2'10" x 8'0" 3'0" x 8'0"	S1400SL ★♦♦♦♦6 12" x 6'8" 14" x 6'8"	S898SL ★♦♦♦♦6 12" x 8'0" 14" x 8'0"

**CLEAR GLASS**

Mahogany	Mahogany	Mahogany
FCM32 ★♦♦♦♦6 2'8" x 6'8" 2'10" x 6'8" 3'0" x 6'8"	FCM32SL ★♦♦♦♦6 12" x 6'8" 14" x 6'8"	FCM881SL ★♦♦♦♦6 12" x 8'0" 14" x 8'0"

Note: See page 285 for important product details that may help with your purchase decision.



**FC32**  
 \* 6  
 2'8" x 6'8"  
 2'10" x 6'8"  
 3'0" x 6'8"

**FC766**  
 \* 6  
 2'8" x 6'8"  
 2'10" x 6'8"  
 3'0" x 6'8"

**81943P**  
 \* 6  
 2'8" x 8'0"  
 2'10" x 8'0"  
 3'0" x 8'0"

**FC32SL**  
 \* 6  
 12" x 6'8"  
 14" x 6'8"

**81943PSL**  
 \* 6  
 12" x 8'0"  
 14" x 8'0"

**S80**  
 \* 6  
 2'8" x 6'8"  
 2'10" x 6'8"  
 3'0" x 6'8"

**S90**  
 \* 6  
 2'8" x 6'8"  
 2'10" x 6'8"  
 3'0" x 6'8"

**S880**  
 \* 6  
 2'8" x 8'0"  
 2'10" x 8'0"  
 3'0" x 8'0"

**S751SL**  
 \* 6  
 12" x 6'8"  
 14" x 6'8"

**S880SL**  
 \* 6  
 12" x 8'0"  
 14" x 8'0"



**Key**

- Low-E Glass (LE)
- Turtle Glass
- Simulated Divided Lites (SDL)
- Flat or Contour White Grilles Between Glass (GBGF / GBGC)

- Flat Almond Grilles Between Glass (GBGF)
- Flat Bronze Grilles Between Glass (GBGF)
- Flat or Contour Black Grilles Between Glass (GBGF / GBGC)

- Fixed Grilles (FXG)
- Flat Lite Frame
- Scrolled & Flat Advanta Lite Frame  
Not available for 2'4" and 2'6" doors or 10" sidelites.

- Scrolled Advanta Lite Frame  
Not available for 2'4" and 2'6" doors or 10" sidelites.
- WBDR Options
- WBDR / HVHZ Options

# Oval Lites



## TRANSOMS

For transoms, see page 209.

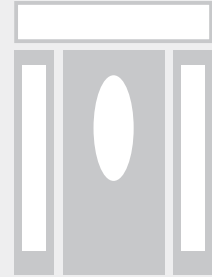

## BLACKSTONE. ♦ ❖ ❖



Mahogany

FCM110

2'8" x 6'8"  
2'10" x 6'8"  
3'0" x 6'8"



Mahogany

FCM164

2'8" x 6'8"  
2'10" x 6'8"  
3'0" x 6'8"



Oak

FC714

2'8" x 6'8"  
2'10" x 6'8"  
3'0" x 6'8"



Oak

FC164

2'8" x 6'8"  
2'10" x 6'8"  
3'0" x 6'8"



Oak

FC794

2'8" x 6'8"  
2'10" x 6'8"  
3'0" x 6'8"



Smooth

S771

2'8" x 6'8"  
2'10" x 6'8"  
3'0" x 6'8"



Smooth

S6085

2'8" x 6'8"  
2'10" x 6'8"  
3'0" x 6'8"

## WELLESLEY.™ ♦ ❖ ❖



Smooth

S997

2'8" x 6'8"  
2'10" x 6'8"  
3'0" x 6'8"

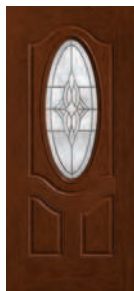

Mahogany

FCM106

2'8" x 6'8"  
2'10" x 6'8"  
3'0" x 6'8"



Mahogany

FCM163

2'8" x 6'8"  
2'10" x 6'8"  
3'0" x 6'8"



Oak

FC713

2'8" x 6'8"  
2'10" x 6'8"  
3'0" x 6'8"



Oak

FC163

2'8" x 6'8"  
2'10" x 6'8"  
3'0" x 6'8"



Oak

FC796

2'8" x 6'8"  
2'10" x 6'8"  
3'0" x 6'8"

Note: See page 285 for important product details that may help with your purchase decision.

Top: Fiber-Classic Mahogany Collection, Concorde Glass, Door - FCM916, Sidelites - FCM809SL, Finish - Rustic Clay

## CONCORDE™



Smooth

S774

2'8" x 6'8"  
2'10" x 6'8"  
3'0" x 6'8"



Smooth

S6082

2'8" x 6'8"  
2'10" x 6'8"  
3'0" x 6'8"



Smooth

S999

2'8" x 6'8"  
2'10" x 6'8"  
3'0" x 6'8"



Mahogany

FCM916

2'8" x 6'8"  
2'10" x 6'8"  
3'0" x 6'8"



Mahogany

FCM915

2'8" x 6'8"  
2'10" x 6'8"  
3'0" x 6'8"



Oak

FC916

2'8" x 6'8"  
2'10" x 6'8"  
3'0" x 6'8"



Oak

FC915

2'8" x 6'8"  
2'10" x 6'8"  
3'0" x 6'8"

## KENSINGTON™



Oak

FC797

2'8" x 6'8"  
2'10" x 6'8"  
3'0" x 6'8"



Smooth

S773

2'8" x 6'8"  
2'10" x 6'8"  
3'0" x 6'8"



Smooth

S6084

2'8" x 6'8"  
2'10" x 6'8"  
3'0" x 6'8"



Smooth

S1000

2'8" x 6'8"  
2'10" x 6'8"  
3'0" x 6'8"



Mahogany

FCM151

2'8" x 6'8"  
2'10" x 6'8"  
3'0" x 6'8"



Mahogany

FCM789

2'8" x 6'8"  
2'10" x 6'8"  
3'0" x 6'8"



Oak

FC709

2'8" x 6'8"  
2'10" x 6'8"  
3'0" x 6'8"

## PEMBRIDGE™



Oak

FCM151

2'8" x 6'8"  
2'10" x 6'8"  
3'0" x 6'8"



Oak

FC798

2'8" x 6'8"  
2'10" x 6'8"  
3'0" x 6'8"



Smooth

S709

2'8" x 6'8"  
2'10" x 6'8"  
3'0" x 6'8"



Smooth

S163

2'8" x 6'8"  
2'10" x 6'8"  
3'0" x 6'8"



Smooth

S1001

2'8" x 6'8"  
2'10" x 6'8"  
3'0" x 6'8"



Mahogany

FCM6577

2'8" x 6'8"  
2'10" x 6'8"  
3'0" x 6'8"



Mahogany

FCM6575

2'8" x 6'8"  
2'10" x 6'8"  
3'0" x 6'8"

PEMBRIDGE Continues on next page.

### Key

- ◆ Black Nickel Caming (1D)
- Brushed Nickel Caming (1C)
- ◆ Brass Caming (1A)

- ▣ Scrolled Advanta Lite Frame  
Not available for 2'4" and 2'6" doors or 10" sidelites.



Oak

FC6577

2'8" x 6'8"  
2'10" x 6'8"  
3'0" x 6'8"



Oak

FC06575

2'8" x 6'8"  
2'10" x 6'8"  
3'0" x 6'8"



Oak

FC6576

2'8" x 6'8"  
2'10" x 6'8"  
3'0" x 6'8"



Smooth

S6577

2'8" x 6'8"  
2'10" x 6'8"  
3'0" x 6'8"



Smooth

S6575

2'8" x 6'8"  
2'10" x 6'8"  
3'0" x 6'8"



Smooth

S6576

2'8" x 6'8"  
2'10" x 6'8"  
3'0" x 6'8"

**CLEAR GLASS**



Mahogany

FCM80

2'8" x 6'8"  
2'10" x 6'8"  
3'0" x 6'8"



Mahogany

FCM160

2'8" x 6'8"  
2'10" x 6'8"  
3'0" x 6'8"



Oak

FC710

2'8" x 6'8"  
2'10" x 6'8"  
3'0" x 6'8"



Oak

FC160

2'8" x 6'8"  
2'10" x 6'8"  
3'0" x 6'8"



Oak

FC789

2'8" x 6'8"  
2'10" x 6'8"  
3'0" x 6'8"



Smooth

S770

2'8" x 6'8"  
2'10" x 6'8"  
3'0" x 6'8"



Smooth

S6080

2'8" x 6'8"  
2'10" x 6'8"  
3'0" x 6'8"



Smooth

S992

2'8" x 6'8"  
2'10" x 6'8"  
3'0" x 6'8"



Note: See page 285 for important product details that may help with your purchase decision.

Bottom: Smooth-Star, Pembriidge Glass, Door S6576

Right Page: Fiber-Classic Mahogany Collection, Salinas Glass, Door – FCM114, Sidelites – FCM814SL, Transom – SART, Finish – Raven

# 1/2 Lites



## TRANSOMS

For transoms, see page 209.

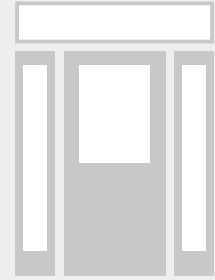

Fiber-Classic® & Smooth-Star®

## BLACKSTONE. ◆◆

 <b>Mahogany</b>		 <b>Mahogany</b>	 <b>Mahogany</b>	 <b>Mahogany</b>	 <b>Oak</b>	 <b>Oak</b>	 <b>Oak</b>			
<b>FCM109</b>  2'8" x 6'8" 2'10" x 6'8" 3'0" x 6'8"	<b>FCM863</b>  2'8" x 8'0" 2'10" x 8'0" 3'0" x 8'0"	<b>FCM6032</b>  2'8" x 6'8" 2'10" x 6'8" 3'0" x 6'8"	<b>FCM6052</b>  2'8" x 6'8" 2'10" x 6'8" 3'0" x 6'8"	<b>FCM109SL</b>  12" x 6'8" 14" x 6'8"	<b>FCM863SL</b>  12" x 8'0" 14" x 8'0"	<b>FC109</b>   2'6" x 6'8" 2'8" x 6'8" (7'0") 2'10" x 6'8" (7'0") 3'0" x 6'8" (7'0")	<b>81933P</b>  2'8" x 8'0" 2'10" x 8'0" 3'0" x 8'0"	<b>81975P</b>  2'8" x 8'0" 2'10" x 8'0" 3'0" x 8'0"	<b>FC109SL</b>  12" x 6'8" 14" x 6'8"	<b>81933PSL</b>  12" x 8'0" 14" x 8'0"
 <b>Smooth</b>		 <b>Smooth</b>	 <b>Smooth</b>	 <b>Smooth</b>	 <b>Smooth</b>	 <b>Smooth</b>	 <b>Smooth</b>			
<b>S6000</b>   2'6" x 6'8" 2'8" x 6'8" (7'0") 2'10" x 6'8" (7'0") 3'0" x 6'8" (7'0")	<b>S81933P</b>  2'8" x 8'0" 2'10" x 8'0" 3'0" x 8'0"	<b>S6032</b>   2'8" x 6'8" (7'0") 2'10" x 6'8" (7'0") 3'0" x 6'8" (7'0")	<b>S86032</b>   2'8" x 8'0" 2'10" x 8'0" 3'0" x 8'0"	<b>S4314</b>   2'8" x 6'8" 2'10" x 6'8" 3'0" x 6'8"	<b>S84314</b>  2'8" x 8'0" 2'10" x 8'0" 3'0" x 8'0"	<b>S6052</b>  2'8" x 6'8" 2'10" x 6'8" 3'0" x 6'8"	<b>S972</b>  2'8" x 6'8" 2'10" x 6'8" 3'0" x 6'8"	<b>S85905</b>  2'8" x 8'0" 2'10" x 8'0" 3'0" x 8'0"	<b>S6000SL</b>  12" x 6'8" 14" x 6'8"	<b>S85912SL</b>  12" x 8'0" 14" x 8'0"

### Key

- Low-E Glass (LE)
- Black Nickel Caming (1D)
- Brushed Nickel Caming (1C)

- Brass Caming (1A)
- Scrolled & Flat Advanta Lite Frame  
Not available for 2'4" and 2'6" doors or 10" sidelites.

- Scrolled Advanta Lite Frame  
Not available for 2'4" and 2'6" doors or 10" sidelites.
- WBDR Options
- WBDR / HVHZ Options

- Elevated 10" Bottom Rail Options

**CRYSTALLINE™** ◆ ◆



Mahogany

FCM898

2'8" x 8'0"  
2'10" x 8'0"  
3'0" x 8'0"



Mahogany

FCM898SL

12" x 8'0"  
14" x 8'0"



Oak

81935P

2'8" x 8'0"  
2'10" x 8'0"  
3'0" x 8'0"



Oak

81977P

2'8" x 8'0"  
2'10" x 8'0"  
3'0" x 8'0"



Oak

81935PSL

12" x 8'0"  
14" x 8'0"



Smooth

S81935P

2'8" x 8'0"  
2'10" x 8'0"  
3'0" x 8'0"



Smooth

S86027

2'8" x 8'0"  
2'10" x 8'0"  
3'0" x 8'0"

**SEDONA** ◆ ◆



NEW

Smooth

S84319

2'8" x 8'0"  
2'10" x 8'0"  
3'0" x 8'0"



Smooth

S85907

2'8" x 8'0"  
2'10" x 8'0"  
3'0" x 8'0"



Smooth

S85914SL

12" x 8'0"  
14" x 8'0"



Mahogany

FCM101

2'8" x 6'8"  
2'10" x 6'8"  
3'0" x 6'8"



FCM864

2'8" x 8'0"  
2'10" x 8'0"  
3'0" x 8'0"



Mahogany

FCM6025

2'8" x 6'8"  
2'10" x 6'8"  
3'0" x 6'8"



Mahogany

FCM6045

2'8" x 6'8"  
2'10" x 6'8"  
3'0" x 6'8"



Mahogany

FCM101SL

12" x 6'8"  
14" x 6'8"



Mahogany

FCM864SL

12" x 8'0"  
14" x 8'0"



Oak

FC101

2'6" x 6'8"  
2'8" x 6'8" (7'0")  
2'10" x 6'8" (7'0")  
3'0" x 6'8" (7'0")



Oak

81978P

2'8" x 8'0"  
2'10" x 8'0"  
3'0" x 8'0"



Oak

FC101SL

12" x 6'8"  
14" x 6'8"



Oak

81936PSL

12" x 8'0"  
14" x 8'0"



Smooth

S211

2'6" x 6'8"  
2'8" x 6'8" (7'0")  
2'10" x 6'8" (7'0")  
3'0" x 6'8" (7'0")



Smooth

S81936P

2'8" x 8'0"  
2'10" x 8'0"  
3'0" x 8'0"





**Smooth**

**S6025**  
 E  
 2'8" x 6'8" (7'0")  
 2'10" x 6'8" (7'0")  
 3'0" x 6'8" (7'0")

**S86025**  
 E  
 2'8" x 8'0"  
 2'10" x 8'0"  
 3'0" x 8'0"

**Smooth**

**S4328**  
 E  
 2'8" x 6'8"  
 2'10" x 6'8"  
 3'0" x 6'8"

**S84328**  
 E  
 2'8" x 8'0"  
 2'10" x 8'0"  
 3'0" x 8'0"

**Smooth**

**S6045**  
 E  
 2'8" x 6'8"  
 2'10" x 6'8"  
 3'0" x 6'8"

**Smooth**

**S35**  
 E  
 2'8" x 6'8"  
 2'10" x 6'8"  
 3'0" x 6'8"

**S833**  
 E  
 2'8" x 8'0"  
 2'10" x 8'0"  
 3'0" x 8'0"

**Smooth**

**S294SL**  
 E  
 12" x 6'8"  
 14" x 6'8"

**S85915SL**  
 E  
 12" x 8'0"  
 14" x 8'0"

**SALINAS® X**



**Mahogany**

**FCM114**  
 G  
 2'8" x 6'8"  
 2'10" x 6'8"  
 3'0" x 6'8"

**FCM865**  
 G  
 2'8" x 8'0"  
 2'10" x 8'0"  
 3'0" x 8'0"

**Mahogany**

**FCM6031**  
 G  
 2'8" x 6'8"  
 2'10" x 6'8"  
 3'0" x 6'8"

**Mahogany**

**FCM6051**  
 G  
 2'8" x 6'8"  
 2'10" x 6'8"  
 3'0" x 6'8"

**Mahogany**

**FCM114SL**  
 G  
 12" x 6'8"  
 14" x 6'8"

**FCM865SL**  
 G  
 12" x 8'0"  
 14" x 8'0"

**Oak**

**FC114**  
 GE  
 2'6" x 6'8"  
 2'8" x 6'8" (7'0")  
 2'10" x 6'8" (7'0")  
 3'0" x 6'8" (7'0")

**81937P**  
 G  
 2'8" x 8'0"  
 2'10" x 8'0"  
 3'0" x 8'0"

**Oak**

**81980P**  
 GE  
 2'8" x 8'0"  
 2'10" x 8'0"  
 3'0" x 8'0"



**Oak**

**FC114SL**  
 G  
 12" x 6'8"  
 14" x 6'8"

**81937PSL**  
 G  
 12" x 8'0"  
 14" x 8'0"

**Smooth**

**S6006**  
 GE  
 2'6" x 6'8"  
 2'8" x 6'8" (7'0")  
 2'10" x 6'8" (7'0")  
 3'0" x 6'8" (7'0")

**S81937P**  
 G  
 2'8" x 8'0"  
 2'10" x 8'0"  
 3'0" x 8'0"

**Smooth**

**S6031**  
 GE  
 2'8" x 6'8" (7'0")  
 2'10" x 6'8" (7'0")  
 3'0" x 6'8" (7'0")

**S86031**  
 GE  
 2'8" x 8'0"  
 2'10" x 8'0"  
 3'0" x 8'0"

**Smooth**

**S4325**  
 GE  
 2'8" x 6'8"  
 2'10" x 6'8"  
 3'0" x 6'8"

**S84325**  
 G  
 2'8" x 8'0"  
 2'10" x 8'0"  
 3'0" x 8'0"

**Smooth**





**S6051**  
 G  
 2'8" x 6'8"  
 2'10" x 6'8"  
 3'0" x 6'8"

**SALINAS** Continues on next page.





**Key**







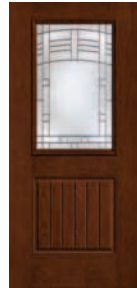

- ◆ Black Nickel Caming (1D)
- Brushed Nickel Caming (1C)
- ✗ Wrought Iron (1W)
- ▣ Scrolled & Flat Advanta Lite Frame  
 Not available for 2'4" and 2'6" doors or 10" sidelites.
- Ⓢ WBDR Options
- Ⓢ WBDR / HVHZ Options
- E Elevated 10" Bottom Rail Options

**SALINAS. X** *Continued*









	
<b>Smooth</b>	<b>Smooth</b>
<b>S973</b> 2'8" x 6'8" 2'10" x 6'8" 3'0" x 6'8"	<b>S893</b> 2'8" x 8'0" 2'10" x 8'0" 3'0" x 8'0"
	
<b>S6006SL</b> 12" x 6'8" 14" x 6'8"	<b>S85916SL</b> 12" x 8'0" 14" x 8'0"

**MAPLE PARK. ◆ ◆**

					
<b>Mahogany</b>	<b>Mahogany</b>	<b>Mahogany</b>	<b>Mahogany</b>	<b>Mahogany</b>	<b>Mahogany</b>
<b>FCM901</b> 2'8" x 6'8" 2'10" x 6'8" 3'0" x 6'8"	<b>FCM886</b> 2'8" x 8'0" 2'10" x 8'0" 3'0" x 8'0"	<b>FCM6107</b> 2'8" x 6'8" 2'10" x 6'8" 3'0" x 6'8"	<b>FCM6108</b> 2'8" x 6'8" 2'10" x 6'8" 3'0" x 6'8"	<b>FCM901SL</b> 12" x 6'8" 14" x 6'8"	<b>FCM886SL</b> 12" x 8'0" 14" x 8'0"

					
<b>Oak</b>	<b>Oak</b>	<b>Oak</b>	<b>Smooth</b>	<b>Smooth</b>	<b>Smooth</b>
<b>FC901</b> 2'8" x 6'8" (7'0") 2'10" x 6'8" (7'0") 3'0" x 6'8" (7'0")	<b>81939P</b> 2'8" x 8'0" 2'10" x 8'0" 3'0" x 8'0"	<b>FC901SL</b> 12" x 6'8" 14" x 6'8"	<b>S6101</b> 2'8" x 6'8" (7'0") 2'10" x 6'8" (7'0") 3'0" x 6'8" (7'0")	<b>S81939P</b> 2'8" x 8'0" 2'10" x 8'0" 3'0" x 8'0"	<b>S6107</b> 2'8" x 6'8" (7'0") 2'10" x 6'8" (7'0") 3'0" x 6'8" (7'0")
					
<b>S86107</b> 2'8" x 8'0" 2'10" x 8'0" 3'0" x 8'0"	<b>S4324</b> 2'8" x 6'8" 2'10" x 6'8" 3'0" x 6'8"	<b>S84324</b> 2'8" x 8'0" 2'10" x 8'0" 3'0" x 8'0"			

**SARATOGA. ◆ ◆**

						
<b>Smooth</b>	<b>Smooth</b>	<b>Smooth</b>	<b>Smooth</b>	<b>Mahogany</b>	<b>Mahogany</b>	<b>Mahogany</b>
<b>S6108</b> 2'8" x 6'8" 2'10" x 6'8" 3'0" x 6'8"	<b>S6106</b> 2'8" x 6'8" 2'10" x 6'8" 3'0" x 6'8"	<b>S85897</b> 2'8" x 8'0" 2'10" x 8'0" 3'0" x 8'0"	<b>S6101SL</b> 12" x 6'8" 14" x 6'8"	<b>FCM906</b> 2'8" x 6'8" 2'10" x 6'8" 3'0" x 6'8"	<b>FCM888</b> 2'8" x 8'0" 2'10" x 8'0" 3'0" x 8'0"	<b>FCM6029</b> 2'8" x 6'8" 2'10" x 6'8" 3'0" x 6'8"
						
				<b>FCM6049</b> 2'8" x 6'8" 2'10" x 6'8" 3'0" x 6'8"		

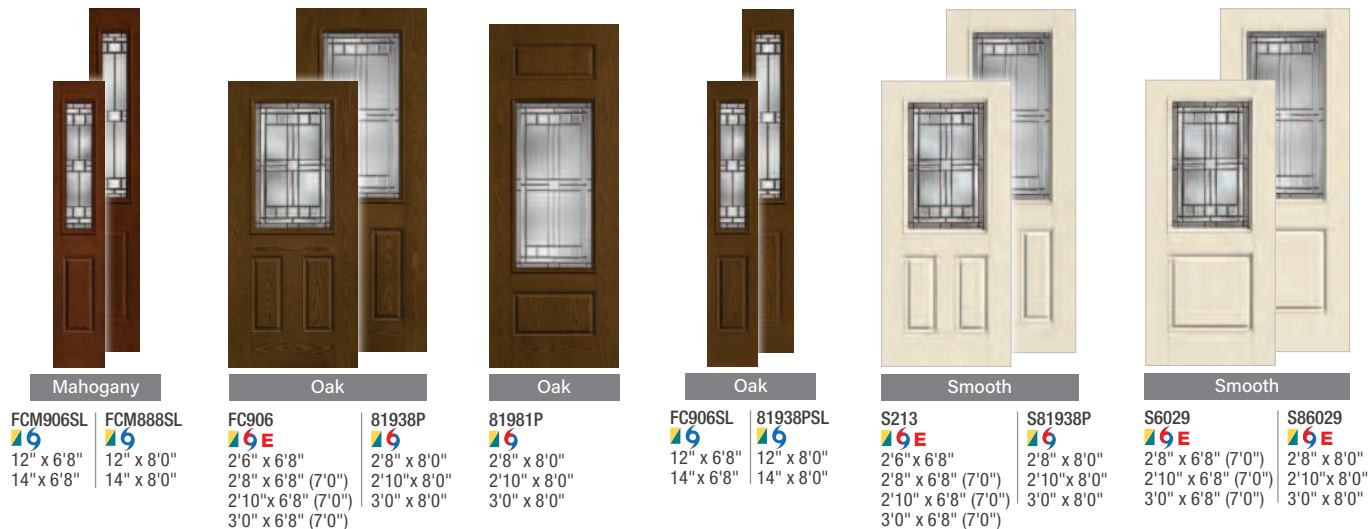

<b>Mahogany</b>		<b>Oak</b>		<b>Oak</b>		<b>Oak</b>		<b>Smooth</b>		<b>Smooth</b>	
FCM906SL 6 12" x 6'8" 14" x 6'8"	FCM888SL 6 12" x 8'0" 14" x 8'0"	FC906 6E 2'6" x 6'8" 2'8" x 6'8" (7'0") 2'10" x 6'8" (7'0") 3'0" x 6'8" (7'0")	81938P 6 2'8" x 8'0" 2'10" x 8'0" 3'0" x 8'0"	81981P 6 2'8" x 8'0" 2'10" x 8'0" 3'0" x 8'0"	FC906SL 6 12" x 6'8" 14" x 6'8"	81938PSL 6 12" x 8'0" 14" x 8'0"	S213 6E 2'6" x 6'8" 2'8" x 6'8" (7'0") 2'10" x 6'8" (7'0") 3'0" x 6'8" (7'0")	S81938P 6 2'8" x 8'0" 2'10" x 8'0" 3'0" x 8'0"	S6029 6E 2'8" x 6'8" (7'0") 2'10" x 6'8" (7'0") 3'0" x 6'8" (7'0")	S86029 6E 2'8" x 8'0" 2'10" x 8'0" 3'0" x 8'0"	

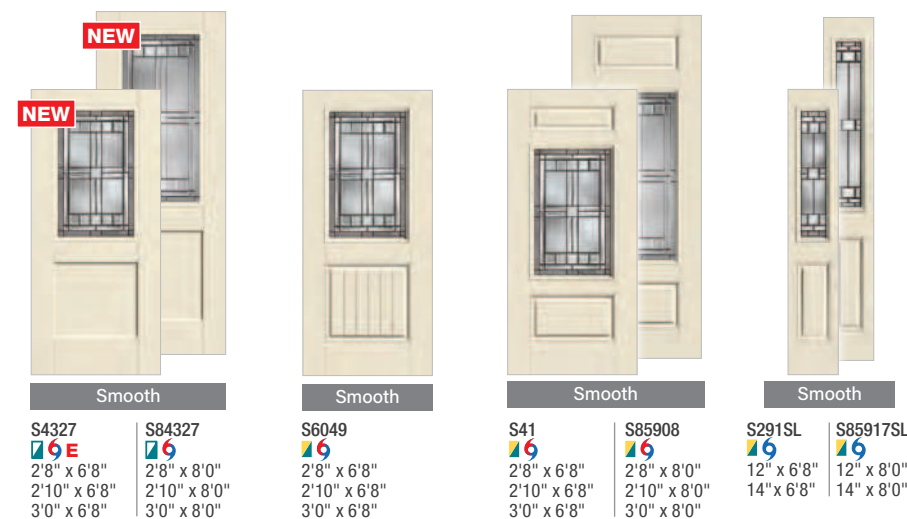

<b>Smooth</b>		<b>Smooth</b>		<b>Smooth</b>		<b>Smooth</b>	
S4327 6E 2'8" x 6'8" 2'10" x 6'8" 3'0" x 6'8"	S84327 6 2'8" x 8'0" 2'10" x 8'0" 3'0" x 8'0"	S6049 6 2'8" x 6'8" 2'10" x 6'8" 3'0" x 6'8"	S41 6 2'8" x 6'8" 2'10" x 6'8" 3'0" x 6'8"	S85908 6 2'8" x 8'0" 2'10" x 8'0" 3'0" x 8'0"	S291SL 6 12" x 6'8" 14" x 6'8"	S85917SL 6 12" x 8'0" 14" x 8'0"	

**TEXAS STAR** ◆ ■

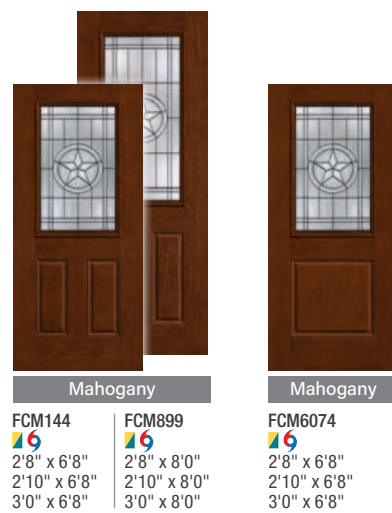

<b>Mahogany</b>		<b>Mahogany</b>	
FCM144 6 2'8" x 6'8" 2'10" x 6'8" 3'0" x 6'8"	FCM899 6 2'8" x 8'0" 2'10" x 8'0" 3'0" x 8'0"	FCM6074 6 2'8" x 6'8" 2'10" x 6'8" 3'0" x 6'8"	

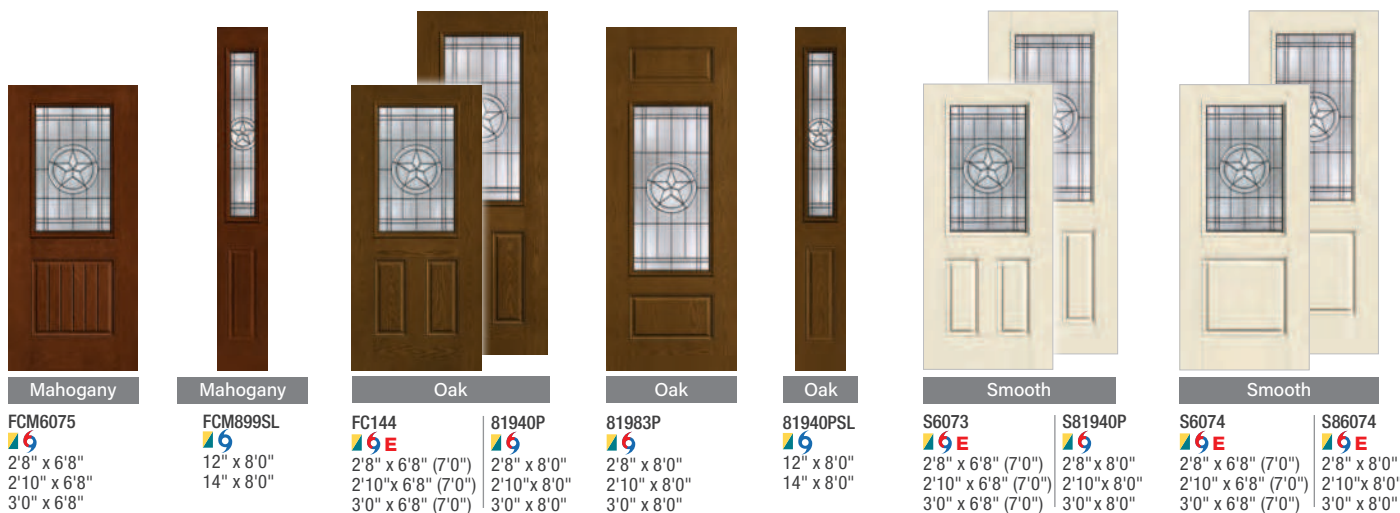

<b>Mahogany</b>		<b>Mahogany</b>		<b>Oak</b>		<b>Oak</b>		<b>Oak</b>		<b>Smooth</b>		<b>Smooth</b>	
FCM6075 6 2'8" x 6'8" 2'10" x 6'8" 3'0" x 6'8"	FCM899SL 6 12" x 8'0" 14" x 8'0"	FC144 6E 2'8" x 6'8" (7'0") 2'10" x 6'8" (7'0") 3'0" x 6'8" (7'0")	81940P 6 2'8" x 8'0" 2'10" x 8'0" 3'0" x 8'0"	81983P 6 2'8" x 8'0" 2'10" x 8'0" 3'0" x 8'0"	81940PSL 6 12" x 8'0" 14" x 8'0"	S6073 6E 2'8" x 6'8" (7'0") 2'10" x 6'8" (7'0") 3'0" x 6'8" (7'0")	S81940P 6 2'8" x 8'0" 2'10" x 8'0" 3'0" x 8'0"	S6074 6E 2'8" x 6'8" (7'0") 2'10" x 6'8" (7'0") 3'0" x 6'8" (7'0")	S86074 6E 2'8" x 8'0" 2'10" x 8'0" 3'0" x 8'0"				





**TEXAS STAR** Continues on next page.

**Key**



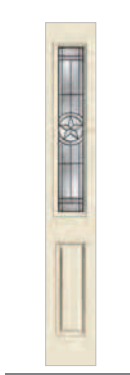

- ◆ Black Nickel Caming (1D)
- Brushed Nickel Caming (1C)
- ✗ Wrought Iron (1W)
- ▣ Scrolled & Flat Advanta Lite Frame  
Not available for 2'4" and 2'6" doors or 10" sidelites.
- ▣ Flat Advanta Lite Frame  
Not available for 2'4" and 2'6" doors or 10" sidelites.
- 6 WBDR Options
- 6 WBDR / HVHZ Options
- E Elevated 10" Bottom Rail Options

**TEXAS STAR** ♦ ■ ■ Continued







**WELLESLEY**™ ♦ ■ ■





											
Smooth		Smooth		Smooth		Smooth		Mahogany		Mahogany	
S4329 NEW 6E 2'8" x 6'8" 2'10" x 6'8" 3'0" x 6'8"	S84329 NEW 6 2'8" x 8'0" 2'10" x 8'0" 3'0" x 8'0"	S6075 6 2'8" x 6'8" 2'10" x 6'8" 3'0" x 6'8"	S6076 6 2'8" x 6'8" 2'10" x 6'8" 3'0" x 6'8"	S81983 6 2'8" x 8'0" 2'10" x 8'0" 3'0" x 8'0"	85919SL 6 12" x 8'0" 14" x 8'0"	FCM105 6 2'8" x 6'8" 2'10" x 6'8" 3'0" x 6'8"	FCM866 6 2'8" x 8'0" 2'10" x 8'0" 3'0" x 8'0"	FCM6030 6 2'8" x 6'8" 2'10" x 6'8" 3'0" x 6'8"			

											
Mahogany		Mahogany		Oak		Oak		Oak		Smooth	
FCM6050 6 2'8" x 6'8" 2'10" x 6'8" 3'0" x 6'8"	FCM105SL 6 12" x 6'8" 14" x 6'8"	FCM866SL 6 12" x 8'0" 14" x 8'0"	FC105 6E 2'6" x 6'8" 2'8" x 6'8" (7'0") 2'10" x 6'8" (7'0") 3'0" x 6'8" (7'0")	81941P 6 2'8" x 8'0" 2'10" x 8'0" 3'0" x 8'0"	81984P 6 2'8" x 8'0" 2'10" x 8'0" 3'0" x 8'0"	FC105SL 6 12" x 6'8" 14" x 6'8"	81941PSL 6 12" x 8'0" 14" x 8'0"	S214 6E 2'6" x 6'8" 2'8" x 6'8" (7'0") 2'10" x 6'8" (7'0") 3'0" x 6'8" (7'0")	S81941P 6 2'8" x 8'0" 2'10" x 8'0" 3'0" x 8'0"		







									
Smooth		Smooth		Smooth		Smooth		Smooth	
S6030 6E 2'8" x 6'8" (7'0") 2'10" x 6'8" (7'0") 3'0" x 6'8" (7'0")	S86030 6E 2'8" x 8'0" 2'10" x 8'0" 3'0" x 8'0"	S4330 NEW 6E 2'8" x 6'8" 2'10" x 6'8" 3'0" x 6'8"	S84330 NEW 6 2'8" x 8'0" 2'10" x 8'0" 3'0" x 8'0"	S6050 6 2'8" x 6'8" 2'10" x 6'8" 3'0" x 6'8"	S42 6 2'8" x 6'8" 2'10" x 6'8" 3'0" x 6'8"	S85909 6 2'8" x 8'0" 2'10" x 8'0" 3'0" x 8'0"	S292SL 6 12" x 6'8" 14" x 6'8"	S85922SL 6 12" x 8'0" 14" x 8'0"	

**RISERVA X**

					
Mahogany		Mahogany		Oak	
FCM581 6 2'8" x 6'8" 2'10" x 6'8" 3'0" x 6'8"	FCM8581 6 2'8" x 8'0" 2'10" x 8'0" 3'0" x 8'0"	FCM575 6 2'8" x 6'8" 2'10" x 6'8" 3'0" x 6'8"	FCM577 6 2'8" x 6'8" 2'10" x 6'8" 3'0" x 6'8"	FCM583SL 6 12" x 6'8" 14" x 6'8"	FCM8583SL 6 12" x 8'0" 14" x 8'0"
FC581 6E 2'6" x 6'8" 2'8" x 6'8" (7'0") 2'10" x 6'8" (7'0") 3'0" x 6'8" (7'0")	FC8581 6 2'8" x 8'0" 2'10" x 8'0" 3'0" x 8'0"	FC8579 6 2'8" x 8'0" 2'10" x 8'0" 3'0" x 8'0"			

				
Oak	Smooth	Smooth	Smooth	Smooth
FC583SL 6 12" x 6'8" 14" x 6'8"	FC8583SL 6 12" x 8'0" 14" x 8'0"	S581 6E 2'6" x 6'8" 2'8" x 6'8" (7'0") 2'10" x 6'8" (7'0") 3'0" x 6'8" (7'0")	S8581 6 2'8" x 8'0" 2'10" x 8'0" 3'0" x 8'0"	S575 6E 2'8" x 6'8" (7'0") 2'10" x 6'8" (7'0") 3'0" x 6'8" (7'0")
S8575 6E 2'8" x 8'0" 2'10" x 8'0" 3'0" x 8'0"	S4326 6E 2'8" x 6'8" 2'10" x 6'8" 3'0" x 6'8"	S84326 6 2'8" x 8'0" 2'10" x 8'0" 3'0" x 8'0"	S577 6 2'8" x 6'8" 2'10" x 6'8" 3'0" x 6'8"	

**CONCORDE**

					
Smooth	Smooth	Mahogany	Mahogany	Mahogany	Mahogany
S579 6 2'8" x 6'8" 2'10" x 6'8" 3'0" x 6'8"	S8579 6 2'8" x 8'0" 2'10" x 8'0" 3'0" x 8'0"	S583SL 6 12" x 6'8" 14" x 6'8"	S8583SL 6 12" x 8'0" 14" x 8'0"	FCM911 6 2'8" x 6'8" 2'10" x 6'8" 3'0" x 6'8"	FCM891 6 2'8" x 8'0" 2'10" x 8'0" 3'0" x 8'0"
FCM6026 6 2'8" x 6'8" 2'10" x 6'8" 3'0" x 6'8"	FCM6046 6 2'8" x 6'8" 2'10" x 6'8" 3'0" x 6'8"	FCM911SL 6 12" x 6'8" 14" x 6'8"	FCM891SL 6 12" x 8'0" 14" x 8'0"		

**CONCORDE** Continues on next page.

**Key**

- ◆ Black Nickel Caming (1D)
- ◆ Scrolled & Flat Advanta Lite Frame  
Not available for 2'4" and 2'6" doors or 10" sidelites.
- ◆ WBDR Options
- ◆ Brushed Nickel Caming (1C)
- ◆ WBDR / HVHZ Options
- ◆ Elevated 10" Bottom Rail Options
- ◆ Brass Caming (1A)



Oak

FC911



2'6" x 6'8"  
2'8" x 6'8" (7'0")  
2'10" x 6'8" (7'0")  
3'0" x 6'8" (7'0")

81942P



2'8" x 8'0"  
2'10" x 8'0"  
3'0" x 8'0"



Oak

81985P



2'8" x 8'0"  
2'10" x 8'0"  
3'0" x 8'0"



Oak

FC911SL



12" x 6'8"  
14" x 6'8"

81942PSL



12" x 8'0"  
14" x 8'0"



Smooth

S426



2'6" x 6'8"  
2'8" x 6'8" (7'0")  
2'10" x 6'8" (7'0")  
3'0" x 6'8" (7'0")

S81942P



2'8" x 8'0"  
2'10" x 8'0"  
3'0" x 8'0"



Smooth

S6026



2'8" x 6'8" (7'0")  
2'10" x 6'8" (7'0")  
3'0" x 6'8" (7'0")

S86026



2'8" x 8'0"  
2'10" x 8'0"  
3'0" x 8'0"



NEW

NEW

Smooth

S4316



2'8" x 6'8"  
2'10" x 6'8"  
3'0" x 6'8"

S84316



2'8" x 8'0"  
2'10" x 8'0"  
3'0" x 8'0"



Smooth

S6046



2'8" x 6'8"  
2'10" x 6'8"  
3'0" x 6'8"

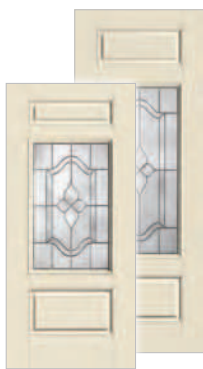

Smooth

S37



2'8" x 6'8"  
2'10" x 6'8"  
3'0" x 6'8"

S837



2'8" x 8'0"  
2'10" x 8'0"  
3'0" x 8'0"



Smooth

S430SL



12" x 6'8"  
14" x 6'8"

S85920SL



12" x 8'0"  
14" x 8'0"

KENSINGTON™  



Mahogany

FCM149



2'8" x 6'8"  
2'10" x 6'8"  
3'0" x 6'8"

FCM8149



2'8" x 8'0"  
2'10" x 8'0"  
3'0" x 8'0"



Mahogany

FCM6036



2'8" x 6'8"  
2'10" x 6'8"  
3'0" x 6'8"



Mahogany

FCM6056



2'8" x 6'8"  
2'10" x 6'8"  
3'0" x 6'8"



Mahogany

FCM149SL



12" x 6'8"  
14" x 6'8"

FCM867SL



12" x 8'0"  
14" x 8'0"



Oak

FC149



2'8" x 6'8" (7'0")  
2'10" x 6'8" (7'0")  
3'0" x 6'8" (7'0")

FC8149



2'8" x 8'0"  
2'10" x 8'0"  
3'0" x 8'0"



Oak

FC89701



2'8" x 8'0"  
2'10" x 8'0"  
3'0" x 8'0"



Oak

FC149SL



12" x 6'8"  
14" x 6'8"

FC8867SL



12" x 8'0"  
14" x 8'0"



Smooth

S161



2'8" x 6'8" (7'0")  
2'10" x 6'8" (7'0")  
3'0" x 6'8" (7'0")

S8149



2'8" x 8'0"  
2'10" x 8'0"  
3'0" x 8'0"

Smooth	Smooth	Smooth	Smooth	Smooth	Smooth	Smooth	Smooth	Smooth
<b>S6036</b> 6E 2'8" x 6'8" (7'0") 2'10" x 6'8" (7'0") 3'0" x 6'8" (7'0")	<b>S86036</b> 6E 2'8" x 8'0" 2'10" x 8'0" 3'0" x 8'0"	<b>S4320</b> 6E 2'8" x 6'8" 2'10" x 6'8" 3'0" x 6'8"	<b>S84320</b> 6 2'8" x 8'0" 2'10" x 8'0" 3'0" x 8'0"	<b>S6056</b> 6 2'8" x 6'8" 2'10" x 6'8" 3'0" x 6'8"	<b>S43</b> 6 2'8" x 6'8" 2'10" x 6'8" 3'0" x 6'8"	<b>S89701</b> 6 2'8" x 8'0" 2'10" x 8'0" 3'0" x 8'0"	<b>S161SL</b> 6 12" x 6'8" 14" x 6'8"	<b>S867SL</b> 6 12" x 8'0" 14" x 8'0"

**PEMBRIDGE** ◆ ◆ ◆

Mahogany	Mahogany	Mahogany	Mahogany	Mahogany	Mahogany	Oak	Oak	Oak
<b>FCM6560</b> 6 2'8" x 6'8" 2'10" x 6'8" 3'0" x 6'8"	<b>FCM86560</b> 6 2'8" x 8'0" 2'10" x 8'0" 3'0" x 8'0"	<b>FCM6565</b> 6 2'8" x 6'8" 2'10" x 6'8" 3'0" x 6'8"	<b>FCM6568</b> 6 2'8" x 6'8" 2'10" x 6'8" 3'0" x 6'8"	<b>FCM6565SL</b> 6 12" x 6'8" 14" x 6'8"	<b>FCM86560SL</b> 6 12" x 8'0" 14" x 8'0"	<b>FC6560</b> 6E 2'6" x 6'8" 2'8" x 6'8" (7'0") 2'10" x 6'8" (7'0") 3'0" x 6'8" (7'0")	<b>FC86560</b> 6 2'8" x 8'0" 2'10" x 8'0" 3'0" x 8'0"	<b>FC86536</b> 6 2'8" x 8'0" 2'10" x 8'0" 3'0" x 8'0"
Oak	Smooth	Smooth	Smooth	Smooth	Smooth	Smooth	Smooth	
<b>FC6565SL</b> 6 12" x 6'8" 14" x 6'8"	<b>FC86560SL</b> 6 12" x 8'0" 14" x 8'0"	<b>S6560</b> 6E 2'6" x 6'8" 2'8" x 6'8" (7'0") 2'10" x 6'8" (7'0") 3'0" x 6'8" (7'0")	<b>S86560</b> 6 2'8" x 8'0" 2'10" x 8'0" 3'0" x 8'0"	<b>S6565</b> 6E 2'8" x 6'8" (7'0") 2'10" x 6'8" (7'0") 3'0" x 6'8" (7'0")	<b>S86565</b> 6E 2'8" x 8'0" 2'10" x 8'0" 3'0" x 8'0"	<b>S4323</b> 6E 2'8" x 6'8" 2'10" x 6'8" 3'0" x 6'8"	<b>S84323</b> 6 2'8" x 8'0" 2'10" x 8'0" 3'0" x 8'0"	<b>S6568</b> 6 2'8" x 6'8" 2'10" x 6'8" 3'0" x 6'8"

PEMBRIDGE Continues on next page.

**Key**

- ◆ Black Nickel Caming (1D)
- ◆ Scrolled & Flat Advanta Lite Frame  
Not available for 2'4" and 2'6" doors or 10" sidelites.
- ◆ WBDOR / HVHZ Options
- ◆ Brushed Nickel Caming (1C)
- ◆ WBDOR Options
- ◆ Brass Caming (1A)
- ◆ Wrought Iron (1W)
- ◆ Elevated 10" Bottom Rail Options

**PEMBRIDGE** ♦ ♦ ♦ Continued



Smooth

<b>S6536</b> 6E 2'8" x 6'8" 2'10" x 6'8" 3'0" x 6'8"	<b>S86536</b> 6E 2'8" x 8'0" 2'10" x 8'0" 3'0" x 8'0"
--	---

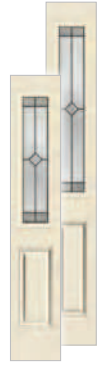

Smooth

<b>S6565SL</b> 6E 12" x 6'8" 14" x 6'8"	<b>S86560SL</b> 6E 12" x 8'0" 14" x 8'0"
--	---

**AXIS** ♦



Mahogany

<b>FCM1654</b> 6E 2'8" x 6'8" 2'10" x 6'8" 3'0" x 6'8"	<b>FCM81654</b> 6E 2'8" x 8'0" 2'10" x 8'0" 3'0" x 8'0"
--	---



Mahogany

<b>FCM1656</b> 6E 2'8" x 6'8" 2'10" x 6'8" 3'0" x 6'8"
--

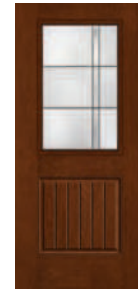

Mahogany

<b>FCM1658</b> 6E 2'8" x 6'8" 2'10" x 6'8" 3'0" x 6'8"
--



Mahogany

<b>FCM1656SL</b> 6E 12" x 6'8" 14" x 6'8"	<b>FCM81654SL</b> 6E 12" x 8'0" 14" x 8'0"
--	---



Oak

<b>FC1654</b> 6E 2'6" x 6'8" 2'8" x 6'8" (7'0") 2'10" x 6'8" (7'0") 3'0" x 6'8" (7'0")	<b>FC81654</b> 6E 2'8" x 8'0" 2'10" x 8'0" 3'0" x 8'0"
---	--



Oak

<b>FC81653</b> 6E 2'8" x 8'0" 2'10" x 8'0" 3'0" x 8'0"
--



Oak

<b>FC1656SL</b> 6E 12" x 6'8" 14" x 6'8"	<b>FC81654SL</b> 6E 12" x 8'0" 14" x 8'0"
---	--



Smooth

<b>S1654</b> 6E 2'6" x 6'8" 2'8" x 6'8" (7'0") 2'10" x 6'8" (7'0") 3'0" x 6'8" (7'0")	<b>S81654</b> 6E 2'8" x 8'0" 2'10" x 8'0" 3'0" x 8'0"
--	---



Smooth

<b>S1656</b> 6E 2'8" x 6'8" (7'0") 2'10" x 6'8" (7'0") 3'0" x 6'8" (7'0")	<b>S81656</b> 6E 2'8" x 8'0" 2'10" x 8'0" 3'0" x 8'0"
---	---

**CALIX** ♦ ♦ ♦



Mahogany

<b>FCM386</b> 6E 2'8" x 6'8" 2'10" x 6'8" 3'0" x 6'8"	<b>FCM8386</b> 6E 2'8" x 8'0" 2'10" x 8'0" 3'0" x 8'0"
---	--



Mahogany

<b>FCM387</b> 6E 2'8" x 6'8" 2'10" x 6'8" 3'0" x 6'8"
---



Smooth

<b>S4311</b> 6E 2'8" x 6'8" 2'10" x 6'8" 3'0" x 6'8"	<b>S84311</b> 6E 2'8" x 8'0" 2'10" x 8'0" 3'0" x 8'0"
--	---



Smooth

<b>S1658</b> 6E 2'8" x 6'8" 2'10" x 6'8" 3'0" x 6'8"
--



Smooth

<b>S1653</b> 6E 2'8" x 6'8" 2'10" x 6'8" 3'0" x 6'8"	<b>S81653</b> 6E 2'8" x 8'0" 2'10" x 8'0" 3'0" x 8'0"
--	---







Smooth







<b>S1656SL</b> 6E 12" x 6'8" 14" x 6'8"	<b>S81654SL</b> 6E 12" x 8'0" 14" x 8'0"
--	---



									
<b>Mahogany</b>	<b>Mahogany</b>	<b>Oak</b>	<b>Oak</b>	<b>Oak</b>	<b>Smooth</b>				
<b>FCM394</b> 6 2'8" x 6'8" 2'10" x 6'8" 3'0" x 6'8"	<b>FCM387SL</b> 6 12" x 6'8" 14" x 6'8"	<b>FCM8386SL</b> 6 12" x 8'0" 14" x 8'0"	<b>FC386</b> 6E 2'6" x 6'8" 2'8" x 6'8" (7'0") 2'10" x 6'8" (7'0") 3'0" x 6'8" (7'0")	<b>FC8386</b> 6 2'8" x 8'0" 2'10" x 8'0" 3'0" x 8'0"	<b>FC8392</b> 6 2'8" x 8'0" 2'10" x 8'0" 3'0" x 8'0"	<b>FC387SL</b> 6 12" x 6'8" 14" x 6'8"	<b>FC8386SL</b> 6 12" x 8'0" 14" x 8'0"	<b>S386</b> 6E 2'6" x 6'8" 2'8" x 6'8" (7'0") 2'10" x 6'8" (7'0") 3'0" x 6'8" (7'0")	<b>S8386</b> 6 2'8" x 8'0" 2'10" x 8'0" 3'0" x 8'0"

								
<b>Smooth</b>	<b>Smooth</b>	<b>Smooth</b>	<b>Smooth</b>	<b>Smooth</b>				
<b>S387</b> 6E 2'8" x 6'8" (7'0") 2'10" x 6'8" (7'0") 3'0" x 6'8" (7'0")	<b>S8387</b> 6E 2'8" x 8'0" 2'10" x 8'0" 3'0" x 8'0"	<b>S4310</b> 6E 2'8" x 6'8" 2'10" x 6'8" 3'0" x 6'8"	<b>S84310</b> 6 2'8" x 8'0" 2'10" x 8'0" 3'0" x 8'0"	<b>S394</b> 6 2'8" x 6'8" 2'10" x 6'8" 3'0" x 6'8"	<b>S392</b> 6 2'8" x 6'8" 2'10" x 6'8" 3'0" x 6'8"	<b>S8392</b> 6 2'8" x 8'0" 2'10" x 8'0" 3'0" x 8'0"	<b>S387SL</b> 6 12" x 6'8" 14" x 6'8"	<b>S8386SL</b> 6 12" x 8'0" 14" x 8'0"

**LATITUDE** ◆ ◆ ◆

						
<b>Mahogany</b>	<b>Mahogany</b>	<b>Oak</b>	<b>Oak</b>	<b>Oak</b>	<b>Smooth</b>	<b>Smooth</b>
<b>FCM8498</b> 6 12" x 8'0" 2'10" x 8'0" 3'0" x 8'0"	<b>FCM8498SL</b> 6 12" x 8'0" 14" x 8'0"	<b>FC8498</b> 6 2'8" x 8'0" 2'10" x 8'0" 3'0" x 8'0"	<b>FC8489</b> 6 2'8" x 8'0" 2'10" x 8'0" 3'0" x 8'0"	<b>FC8498SL</b> 6 12" x 8'0" 14" x 8'0"	<b>S8498</b> 6 2'8" x 8'0" 2'10" x 8'0" 3'0" x 8'0"	<b>S8467</b> 6 2'8" x 8'0" 2'10" x 8'0" 3'0" x 8'0"

**LATITUDE** Continues on next page.

**Key**

- ◆ Black Nickel Caming (1D)
- ◆ Brushed Nickel Caming (1C)
- ◆ Brass Caming (1A)

◆ Scrolled & Flat Advanta Lite Frame  
Not available for 2'4" and 2'6" doors or 10" sidelites.

◆ WBDR Options

- ◆ WBDR / HVHZ Options
- ◆ Elevated 10" Bottom Rail Options

**LATITUDE** ◆ ◆ ◆ *Continued*

**PRIVACY & TEXTURED GLASS WITH DIVIDED LITES**



**NEW**

Smooth

S84322

2'8" x 8'0"  
2'10" x 8'0"  
3'0" x 8'0"

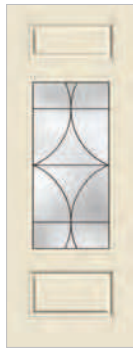

Smooth

S8499

2'8" x 8'0"  
2'10" x 8'0"  
3'0" x 8'0"



Smooth

S8498SL

12" x 8'0"  
14" x 8'0"



Mahogany

FCM65\_

2'8" x 6'8"  
2'10" x 6'8"  
3'0" x 6'8"



Mahogany

FCM6022\_

2'8" x 6'8"  
2'10" x 6'8"  
3'0" x 6'8"



Mahogany

FCM6042\_

2'8" x 6'8"  
2'10" x 6'8"  
3'0" x 6'8"



Mahogany

FCM8321\_

2'8" x 8'0"  
2'10" x 8'0"  
3'0" x 8'0"



Mahogany

FCM65\_SL

12" x 6'8"  
14" x 6'8"



Mahogany

FCM3487\_SL

12" x 8'0"  
14" x 8'0"



Oak

FC65\_

2'8" x 6'8" (7'0")  
2'10" x 6'8" (7'0")  
3'0" x 6'8" (7'0")



Oak

FC8321\_

2'8" x 8'0"  
2'10" x 8'0"  
3'0" x 8'0"



Oak

FC832\_

2'8" x 8'0"  
2'10" x 8'0"  
3'0" x 8'0"



Oak

FC63\_SL

12" x 6'8"  
14" x 6'8"



Oak

FC3487\_SL

12" x 8'0"  
14" x 8'0"



Smooth

S262\_

2'8" x 6'8" (7'0")  
2'10" x 6'8" (7'0")  
3'0" x 6'8" (7'0")



Smooth

S6022\_

2'8" x 6'8" (7'0")  
2'10" x 6'8" (7'0")  
3'0" x 6'8" (7'0")



Smooth

S6042\_

2'8" x 6'8"  
2'10" x 6'8"  
3'0" x 6'8"



Smooth

S32\_

2'8" x 6'8"  
2'10" x 6'8"  
3'0" x 6'8"



Smooth

S8321\_

2'8" x 8'0"  
2'10" x 8'0"  
3'0" x 8'0"



Smooth

S86022\_

2'8" x 8'0"  
2'10" x 8'0"  
3'0" x 8'0"



Smooth

S832\_

2'8" x 8'0"  
2'10" x 8'0"  
3'0" x 8'0"

**Privacy & Textured Glass Options**

Add the code to the blank in the style number for the desired door and glass combination. For details on glass options, see page 119.

XK = Reeded

XE = Satin Etch

XC = Chord

XJ = Chinchilla









XR = Rainglass

XN = Granite

## PRIVACY & TEXTURED GLASS



 <b>Smooth</b> S263_SL  12" x 6'8" 14" x 6'8"		 <b>Smooth</b> S3487_SL  12" x 8'0" 14" x 8'0"		 <b>Mahogany</b> FCM62_  2'8" x 6'8" 2'10" x 6'8" 3'0" x 6'8"		 <b>Mahogany</b> FCM862_  2'8" x 8'0" 2'10" x 8'0" 3'0" x 8'0"		 <b>Mahogany</b> FCM6021_  2'8" x 6'8" 2'10" x 6'8" 3'0" x 6'8"		 <b>Mahogany</b> FCM6041_  2'8" x 6'8" 2'10" x 6'8" 3'0" x 6'8"		 <b>Mahogany</b> FCM104_  2'8" x 6'8" (7'0") 2'10" x 6'8" (7'0") 3'0" x 6'8" (7'0")							
 <b>Mahogany</b> FCM62_SL  12" x 6'8" 14" x 6'8"		 <b>Oak</b> FCM862_SL  12" x 8'0" 14" x 8'0"		 <b>Oak</b> FC62_  2'8" x 6'8" (7'0") 2'10" x 6'8" (7'0") 3'0" x 6'8" (7'0")		 <b>Oak</b> 81929P_  2'8" x 8'0" 2'10" x 8'0" 3'0" x 8'0"		 <b>Oak</b> FC104_  2'8" x 6'8" (7'0") 2'10" x 6'8" (7'0") 3'0" x 6'8" (7'0")		 <b>Oak</b> 81971P_  2'8" x 8'0" 2'10" x 8'0" 3'0" x 8'0"		 <b>Oak</b> FC48_SL  12" x 6'8" 14" x 6'8"		 <b>Oak</b> 81929P_SL  12" x 8'0" 14" x 8'0"		 <b>Smooth</b> S206_  2'8" x 6'8" (7'0") 2'10" x 6'8" (7'0") 3'0" x 6'8" (7'0")		 <b>Smooth</b> S81929P_  2'8" x 8'0" 2'10" x 8'0" 3'0" x 8'0"	
 <b>Smooth</b> S6021_  2'8" x 6'8" (7'0") 2'10" x 6'8" (7'0") 3'0" x 6'8" (7'0")		 <b>Smooth</b> S86021_  2'8" x 8'0" 2'10" x 8'0" 3'0" x 8'0"		 <b>Smooth</b> S4305_  2'8" x 6'8" 2'10" x 6'8" 3'0" x 6'8"		 <b>Smooth</b> S84305_  2'8" x 8'0" 2'10" x 8'0" 3'0" x 8'0"		 <b>Smooth</b> S6041_  2'8" x 6'8" 2'10" x 6'8" 3'0" x 6'8"		 <b>Smooth</b> S104_  2'8" x 6'8" (7'0") 2'10" x 6'8" (7'0") 3'0" x 6'8" (7'0")		 <b>Smooth</b> S30_  2'8" x 6'8" 2'10" x 6'8" 3'0" x 6'8"		 <b>Smooth</b> S830_  2'8" x 8'0" 2'10" x 8'0" 3'0" x 8'0"		 <b>Smooth</b> S210_SL  12" x 6'8" 14" x 6'8"		 <b>Smooth</b> S85910_SL  12" x 8'0" 14" x 8'0"	







### Key

-  Black Nickel Caming (1D)
-  Brushed Nickel Caming (1C)
-  Brass Caming (1A)
-  Simulated Divided Lites (SDL)
-  Scrolled & Flat Advanta Lite Frame  
Not available for 2'4" and 2'6" doors or 10" sidelites.
-  WBDR / HVHZ Options
-  Elevated 10" Bottom Rail Options
-  WBDR Options

## INTERNAL BLINDS

								
Mahogany		Mahogany		Mahogany	Oak			
FCM678 ★🔧 2'8" x 6'8" 2'10" x 6'8" 3'0" x 6'8"	FCM8678 ★🔧 2'8" x 8'0" 2'10" x 8'0" 3'0" x 8'0"	FCM6035 ★🔧 2'8" x 6'8" 2'10" x 6'8" 3'0" x 6'8"	FCM6055 ★🔧 2'8" x 6'8" 2'10" x 6'8" 3'0" x 6'8"	FCM116 ★🔧🔧E 2'6" x 6'8" (7'0") 2'8" x 6'8" (7'0") 2'10" x 6'8" (7'0") 3'0" x 6'8" (7'0")	FCM678SL ★🔧 12" x 6'8" 14" x 6'8"	FCM8678SL ★🔧 12" x 8'0" 14" x 8'0"	FC678 ★🔧E 2'6" x 6'8" 2'8" x 6'8" (7'0") 2'10" x 6'8" (7'0") 3'0" x 6'8" (7'0")	FC8678 ★🔧 2'8" x 8'0" 2'10" x 8'0" 3'0" x 8'0"

									
Oak	Oak	Oak	Smooth	Smooth	Smooth	Smooth			
FC116 ★🔧🔧E 2'6" x 6'8" (7'0") 2'8" x 6'8" (7'0") 2'10" x 6'8" (7'0") 3'0" x 6'8" (7'0")	FC8971 ★🔧 2'8" x 8'0" 2'10" x 8'0" 3'0" x 8'0"	FC678SL ★🔧 12" x 6'8" 14" x 6'8"	FC8678SL ★🔧 12" x 8'0" 14" x 8'0"	S132 ★🔧🔧E 2'6" x 6'8" 2'8" x 6'8" (7'0") 2'10" x 6'8" (7'0") 3'0" x 6'8" (7'0")	S8132 ★🔧 2'8" x 8'0" 2'10" x 8'0" 3'0" x 8'0"	S6035 ★🔧🔧E 2'8" x 6'8" (7'0") 2'10" x 6'8" (7'0") 3'0" x 6'8" (7'0")	S86035 ★🔧🔧E 2'8" x 8'0" 2'10" x 8'0" 3'0" x 8'0"	S4308 ★🔧🔧E 2'8" x 6'8" 2'10" x 6'8" 3'0" x 6'8"	S84308 ★🔧 2'8" x 8'0" 2'10" x 8'0" 3'0" x 8'0"

							
Smooth	Smooth	Smooth	Smooth	Smooth	Smooth	Smooth	
S6055 ★🔧 2'8" x 6'8" 2'10" x 6'8" 3'0" x 6'8"	S131 ★🔧🔧E 2'6" x 6'8" 2'8" x 6'8" (7'0") 2'10" x 6'8" (7'0") 3'0" x 6'8" (7'0")	S971 ★🔧 2'8" x 6'8" 2'10" x 6'8" 3'0" x 6'8"	S8971 ★🔧 2'8" x 8'0" 2'10" x 8'0" 3'0" x 8'0"	S132SL ★🔧 12" x 6'8" 14" x 6'8"	S8132SL ★🔧 12" x 8'0" 14" x 8'0"	S243 E 2'8" x 6'8" (7'0") 2'10" x 6'8" (7'0") 3'0" x 6'8" (7'0")	S6034 E 2'8" x 6'8" (7'0") 2'10" x 6'8" (7'0") 3'0" x 6'8" (7'0")

### SCREEN VENTED LITES\*

\*Features a gliding operation and sash locking system.

Note: See page 285 for important product details that may help with your purchase decision.

## CLEAR GLASS WITH DIVIDED LITES



Smooth

S6054  
2'8" x 6'8"  
2'10" x 6'8"  
3'0" x 6'8"



Smooth

S137  
E  
2'8" x 6'8" (7'0")  
2'10" x 6'8" (7'0")  
3'0" x 6'8" (7'0")



Mahogany

FCM8322  
2'8" x 8'0"  
2'10" x 8'0"  
3'0" x 8'0"



Mahogany

FCM8323  
2'8" x 8'0"  
2'10" x 8'0"  
3'0" x 8'0"



Mahogany

FCM8324  
2'8" x 8'0"  
2'10" x 8'0"  
3'0" x 8'0"



Mahogany

FCM65  
2'8" x 6'8"  
2'10" x 6'8"  
3'0" x 6'8"



Mahogany

FCM6022  
2'8" x 6'8"  
2'10" x 6'8"  
3'0" x 6'8"



Mahogany

FCM6042  
2'8" x 6'8"  
2'10" x 6'8"  
3'0" x 6'8"

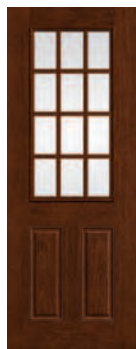

Mahogany

FCM8321  
2'8" x 8'0"  
2'10" x 8'0"  
3'0" x 8'0"



Mahogany

FCM8675SL  
12" x 8'0"  
14" x 8'0"



Mahogany

FCM65SL  
12" x 6'8"  
14" x 6'8"



Mahogany

FCM7125SL  
12" x 8'0"  
14" x 8'0"



Mahogany

FCM3487SL  
12" x 8'0"  
14" x 8'0"



Mahogany

FCM1408  
2'8" x 6'8"  
2'10" x 6'8"  
3'0" x 6'8"



Mahogany

FCM8145  
2'8" x 8'0"  
2'10" x 8'0"  
3'0" x 8'0"



Mahogany

FCM1405  
2'8" x 6'8"  
2'10" x 6'8"  
3'0" x 6'8"



Mahogany

FCM1406  
2'8" x 6'8"  
2'10" x 6'8"  
3'0" x 6'8"



Mahogany

FCM1405SL  
12" x 6'8"  
14" x 6'8"



Mahogany

FCM8145SL  
12" x 8'0"  
14" x 8'0"



Oak

FC8322  
2'8" x 8'0"  
2'10" x 8'0"  
3'0" x 8'0"



Oak

FC8323  
2'8" x 8'0"  
2'10" x 8'0"  
3'0" x 8'0"



Oak

FC8324  
2'8" x 8'0"  
2'10" x 8'0"  
3'0" x 8'0"



Oak

FC65  
2'6" x 6'8"  
2'8" x 6'8" (7'0")  
2'10" x 6'8" (7'0")  
3'0" x 6'8" (7'0")



Oak

FC8321  
2'8" x 8'0"  
2'10" x 8'0"  
3'0" x 8'0"

CLEAR GLASS WITH DIVIDED LITES *Continues on next page.*

### Key

■ No Stile Lines

★ Low-E Glass (LE)

▣ Scrolled & Flat Advanta Lite Frame  
Not available for 2'4" and 2'6" doors or 10" sidelites.

Ⓢ WBDOR Options

Ⓢ WBDOR / HVHZ Options

E Elevated 10" Bottom Rail Options

**CLEAR GLASS WITH DIVIDED LITES** *Continued*



Oak

**FC8318**  
 2'8" x 8'0"  
 2'10" x 8'0"  
 3'0" x 8'0"



Oak

**FC8319**  
 2'8" x 8'0"  
 2'10" x 8'0"  
 3'0" x 8'0"



Oak

**FC8320**  
 2'8" x 8'0"  
 2'10" x 8'0"  
 3'0" x 8'0"

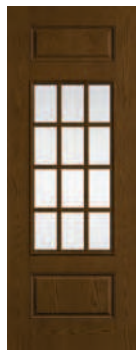

Oak

**FC832**  
 2'8" x 8'0"  
 2'10" x 8'0"  
 3'0" x 8'0"



Oak

**FC8675SL**  
 12" x 8'0"  
 14" x 8'0"



Oak

**FC63SL** | **FC7125SL**  
 12" x 6'8"  
 14" x 6'8" | 12" x 8'0"  
 14" x 8'0"



Oak

**FC3487SL**  
 12" x 8'0"  
 14" x 8'0"



Oak

**FC1408**  
 2'6" x 6'8"  
 2'8" x 6'8" (7'0")  
 2'10" x 6'8" (7'0")  
 3'0" x 6'8" (7'0")



Oak

**FC8145**  
 2'8" x 8'0"  
 2'10" x 8'0"  
 3'0" x 8'0"

**FC8144**  
 2'8" x 8'0"  
 2'10" x 8'0"  
 3'0" x 8'0"



Oak

**FC1408SL** | **FC8145SL**  
 12" x 6'8"  
 14" x 6'8" | 12" x 8'0"  
 14" x 8'0"



Smooth

**S8322**  
 2'8" x 8'0"  
 2'10" x 8'0"  
 3'0" x 8'0"



Smooth

**S8326**  
 2'8" x 8'0"  
 2'10" x 8'0"  
 3'0" x 8'0"



**NEW**

Smooth

**S84318**  
 2'8" x 8'0"  
 2'10" x 8'0"  
 3'0" x 8'0"



Smooth

**S8323**  
 2'8" x 8'0"  
 2'10" x 8'0"  
 3'0" x 8'0"



Smooth

**S8327**  
 2'8" x 8'0"  
 2'10" x 8'0"  
 3'0" x 8'0"



**NEW**

Smooth

**S84313**  
 2'8" x 8'0"  
 2'10" x 8'0"  
 3'0" x 8'0"



Smooth

**S8324**  
 2'8" x 8'0"  
 2'10" x 8'0"  
 3'0" x 8'0"



Smooth

**S8328**  
 2'8" x 8'0"  
 2'10" x 8'0"  
 3'0" x 8'0"



**NEW**

Smooth

**S84309**  
 2'8" x 8'0"  
 2'10" x 8'0"  
 3'0" x 8'0"





























Smooth

**S262**  
 2'6" x 6'8"  
 2'8" x 6'8" (7'0")  
 2'10" x 6'8" (7'0")  
 3'0" x 6'8" (7'0")



Smooth

**S6022**  
 2'8" x 6'8" (7'0")  
 2'10" x 6'8" (7'0")  
 3'0" x 6'8" (7'0")

 <p><b>NEW</b></p> <p>Smooth</p> <p><b>S4307</b>              ◆◆◆◆◆              2'8" x 6'8"              2'10" x 6'8"              3'0" x 6'8"</p>	 <p>Smooth</p> <p><b>S6042</b>              ◆◆◆◆◆              ◆◆◆◆◆              2'8" x 6'8"              2'10" x 6'8"              3'0" x 6'8"</p>	 <p>Smooth</p> <p><b>S8321</b>              ◆◆◆◆◆              ◆◆◆◆◆              2'8" x 8'0"              2'10" x 8'0"              3'0" x 8'0"</p>	 <p>Smooth</p> <p><b>S8325</b>              ◆◆◆◆◆              ◆◆◆◆◆              2'8" x 8'0"              2'10" x 8'0"              3'0" x 8'0"</p>	 <p><b>NEW</b></p> <p>Smooth</p> <p><b>S84312</b>              ◆◆◆◆◆              ◆◆◆◆◆              2'8" x 8'0"              2'10" x 8'0"              3'0" x 8'0"</p>	 <p>Smooth</p> <p><b>S8318</b>              ◆◆◆◆◆              ◆◆◆◆◆              2'8" x 8'0"              2'10" x 8'0"              3'0" x 8'0"</p>	 <p>Smooth</p> <p><b>S8319</b>              ◆◆◆◆◆              ◆◆◆◆◆              2'8" x 8'0"              2'10" x 8'0"              3'0" x 8'0"</p>			
 <p>Smooth</p> <p><b>S8320</b>              ◆◆◆◆◆              2'8" x 8'0"              2'10" x 8'0"              3'0" x 8'0"</p>	 <p>Smooth</p> <p><b>S32</b>              ◆◆◆◆◆              ◆◆◆◆◆              2'8" x 6'8"              2'10" x 6'8"              3'0" x 6'8"</p>	 <p>Smooth</p> <p><b>S832</b>              ◆◆◆◆◆              ◆◆◆◆◆              2'8" x 8'0"              2'10" x 8'0"              3'0" x 8'0"</p>	 <p>Smooth</p> <p><b>S115</b>              ◆◆◆◆◆              2'6" x 6'8"              2'8" x 6'8" (7'0")              2'10" x 6'8" (7'0")              3'0" x 6'8" (7'0")</p>	 <p>Smooth</p> <p><b>S8675SL</b>              ◆◆◆◆◆              ◆◆◆◆◆              12" x 8'0"              14" x 8'0"</p>	 <p>Smooth</p> <p><b>S263SL</b>              ◆◆◆◆◆              ◆◆◆◆◆              12" x 6'8"              14" x 6'8"</p>	 <p>Smooth</p> <p><b>S7125SL</b>              ◆◆◆◆◆              ◆◆◆◆◆              12" x 8'0"              14" x 8'0"</p>	 <p>Smooth</p> <p><b>S3487SL</b>              ◆◆◆◆◆              ◆◆◆◆◆              12" x 8'0"              14" x 8'0"</p>	 <p>Smooth</p> <p><b>S1408</b>              ◆◆◆◆◆              ◆◆◆◆◆              2'6" x 6'8"              2'8" x 6'8" (7'0")              2'10" x 6'8" (7'0")              3'0" x 6'8" (7'0")</p>	 <p>Smooth</p> <p><b>S8145</b>              ◆◆◆◆◆              ◆◆◆◆◆              2'8" x 8'0"              2'10" x 8'0"              3'0" x 8'0"</p>
 <p>Smooth</p> <p><b>S1405</b>              ◆◆◆◆◆              ◆◆◆◆◆              2'8" x 6'8" (7'0")              2'10" x 6'8" (7'0")              3'0" x 6'8" (7'0")</p>	 <p>Smooth</p> <p><b>S81405</b>              ◆◆◆◆◆              ◆◆◆◆◆              2'8" x 8'0"              2'10" x 8'0"              3'0" x 8'0"</p>	 <p><b>NEW</b></p> <p>Smooth</p> <p><b>S4321</b>              ◆◆◆◆◆              ◆◆◆◆◆              2'8" x 6'8"              2'10" x 6'8"              3'0" x 6'8"</p>	 <p><b>NEW</b></p> <p>Smooth</p> <p><b>S84321</b>              ◆◆◆◆◆              ◆◆◆◆◆              2'8" x 8'0"              2'10" x 8'0"              3'0" x 8'0"</p>	 <p>Smooth</p> <p><b>S1406</b>              ◆◆◆◆◆              ◆◆◆◆◆              2'8" x 6'8"              2'10" x 6'8"              3'0" x 6'8"</p>	 <p>Smooth</p> <p><b>S1407</b>              ◆◆◆◆◆              ◆◆◆◆◆              2'8" x 6'8"              2'10" x 6'8"              3'0" x 6'8"</p>	 <p>Smooth</p> <p><b>S8144</b>              ◆◆◆◆◆              ◆◆◆◆◆              2'8" x 8'0"              2'10" x 8'0"              3'0" x 8'0"</p>	 <p>Smooth</p> <p><b>S1405SL</b>              ◆◆◆◆◆              ◆◆◆◆◆              12" x 6'8"              14" x 6'8"</p>	 <p>Smooth</p> <p><b>S8145SL</b>              ◆◆◆◆◆              ◆◆◆◆◆              12" x 8'0"              14" x 8'0"</p>	

**Key**

- ◆ Low-E Glass (LE)
- ◆ Simulated Divided Lites (SDL)
- ◆ Flat or Contour White Grilles Between Glass (GBGF / GBGC)

- ◆ Flat Almond Grilles Between Glass (GBGF)
- ◆ Flat Bronze Grilles Between Glass (GBGF)
- ◆ Flat or Contour Black Grilles Between Glass (GBGF / GBGC)

- ◆ Fixed Grilles (FXG)
- ◆ Scrolled & Flat Advanta Lite Frame  
Not available for 2'4" and 2'6" doors or 10" sidelites.
- ◆ WBDR Options

- ◆ WBDR / HVHZ Options
- ◆ Elevated 10" Bottom Rail Options

CLEAR GLASS



Mahogany

FCM62  
★🔥🔥  
2'8" x 6'8"  
2'10" x 6'8"  
3'0" x 6'8"

FCM862  
★🔥🔥  
2'8" x 8'0"  
2'10" x 8'0"  
3'0" x 8'0"



Mahogany

FCM6021  
★🔥🔥  
2'8" x 6'8"  
2'10" x 6'8"  
3'0" x 6'8"



Mahogany

FCM6041  
★🔥🔥  
2'8" x 6'8"  
2'10" x 6'8"  
3'0" x 6'8"

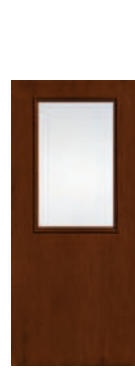

Mahogany

FCM670  
★🔥🔥E  
2'6" x 6'8" (7'0")  
2'8" x 6'8" (7'0")  
2'10" x 6'8" (7'0")  
3'0" x 6'8" (7'0")



Mahogany

FCM62SL  
★🔥🔥  
12" x 6'8"  
14" x 6'8"



Oak

FC62  
★🔥🔥E  
2'6" x 6'8"  
2'8" x 6'8" (7'0")  
2'10" x 6'8" (7'0")  
3'0" x 6'8" (7'0")

81929P  
★🔥🔥  
2'8" x 8'0"  
2'10" x 8'0"  
3'0" x 8'0"



Oak

FC670  
★🔥🔥E  
2'6" x 6'8" (7'0")  
2'8" x 6'8" (7'0")  
2'10" x 6'8" (7'0")  
3'0" x 6'8" (7'0")



Oak

81971P  
★🔥🔥  
2'8" x 8'0"  
2'10" x 8'0"  
3'0" x 8'0"



Oak

FC48SL  
★🔥🔥  
12" x 6'8"  
14" x 6'8"

81929PSL  
★🔥🔥  
12" x 8'0"  
14" x 8'0"



Smooth

S206  
★🔥🔥E  
2'6" x 6'8"  
2'8" x 6'8" (7'0")  
2'10" x 6'8" (7'0")  
3'0" x 6'8" (7'0")

S81929P  
★🔥🔥  
2'8" x 8'0"  
2'10" x 8'0"  
3'0" x 8'0"



Smooth

S6021  
★🔥🔥E  
2'8" x 6'8" (7'0")  
2'10" x 6'8" (7'0")  
3'0" x 6'8" (7'0")

S86021  
★🔥🔥E  
2'8" x 8'0"  
2'10" x 8'0"  
3'0" x 8'0"



Smooth

S4315  
★🔥E  
2'8" x 6'8"  
2'10" x 6'8"  
3'0" x 6'8"

S84315  
★🔥  
2'8" x 8'0"  
2'10" x 8'0"  
3'0" x 8'0"



Smooth

S6041  
★🔥🔥  
2'8" x 6'8"  
2'10" x 6'8"  
3'0" x 6'8"



Smooth

S104  
★🔥🔥E  
2'6" x 6'8"  
2'8" x 6'8" (7'0")  
2'10" x 6'8" (7'0")  
3'0" x 6'8" (7'0")

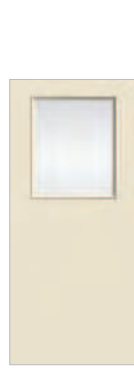

Smooth

S105  
★🔥🔥E  
2'6" x 6'8"  
2'8" x 6'8" (7'0")  
2'10" x 6'8" (7'0")  
3'0" x 6'8" (7'0")



Smooth

S30  
★🔥🔥  
2'8" x 6'8"  
2'10" x 6'8"  
3'0" x 6'8"

S830  
★🔥🔥  
2'8" x 8'0"  
2'10" x 8'0"  
3'0" x 8'0"



Smooth

S210SL  
★🔥🔥  
12" x 6'8"  
14" x 6'8"

S85910SL  
★🔥🔥  
12" x 8'0"  
14" x 8'0"

Note: See page 285 for important product details that may help with your purchase decision.



# Twin 1/2 Lites



## TRANSOMS

For transoms, see page 209.



### BLACKSTONE. ◆ ◆



Smooth

S6013  
 2'8" x 6'8"  
 2'10" x 6'8"  
 3'0" x 6'8"

### SEDONA ◆ ◆



Smooth

S294  
 2'8" x 6'8"  
 2'10" x 6'8"  
 3'0" x 6'8"

### SALINAS. ✕



Smooth

S6014  
 2'8" x 6'8"  
 2'10" x 6'8"  
 3'0" x 6'8"

### MAPLE PARK. ◆ ◆



Smooth

S6104  
 2'8" x 6'8"  
 2'10" x 6'8"  
 3'0" x 6'8"

### SARATOGA. ◆ ◆



Smooth

S291  
 2'8" x 6'8"  
 2'10" x 6'8"  
 3'0" x 6'8"

### WELLESLEY. ◆ ◆ ◆



Smooth

S292  
 2'8" x 6'8"  
 2'10" x 6'8"  
 3'0" x 6'8"

### RISERVA. ✕



Smooth

S585  
 2'8" x 6'8"  
 2'10" x 6'8"  
 3'0" x 6'8"

### CONCORDE. ◆ ◆ ◆



Smooth

S430  
 2'8" x 6'8"  
 2'10" x 6'8"  
 3'0" x 6'8"

## Key

- No Stile Lines
- ☀ Low-E Glass (LE)
- 🗉 Simulated Divided Lites (SDL)
- ◆ Flat or Contour White Grilles Between Glass (GBGF / GBGC)
- ◆ Flat Bronze Grilles Between Glass (GBGF)
- ◆ Flat or Contour Black Grilles Between Glass (GBGF / GBGC)
- ◆ Fixed Grilles (FXG)
- ◆ Scrolled & Flat Advanta Lite Frame  
Not available for 2'4" and 2'6" doors or 10" sidelites.
- 6 WBDL Options
- 6 WBDL / HVHZ Options
- E Elevated 10" Bottom Rail Options

**KENSINGTON™** ◆ ◆ ◆



Smooth

S162

2'8" x 6'8"  
2'10" x 6'8"  
3'0" x 6'8"

**PEMBRIDGE™** ◆ ◆ ◆ ◆



Smooth

S6572

2'8" x 6'8"  
2'10" x 6'8"  
3'0" x 6'8"

**AXIS◆**



Smooth

S1661

2'8" x 6'8"  
2'10" x 6'8"  
3'0" x 6'8"

**CALIX◆** ◆ ◆ ◆ ◆



Smooth

S398

2'8" x 6'8"  
2'10" x 6'8"  
3'0" x 6'8"

**PRIVACY & TEXTURED  
GLASS WITH DIVIDED LITES**



Smooth

S807\_

2'8" x 6'8"  
2'10" x 6'8"  
3'0" x 6'8"

**PRIVACY &  
TEXTURED GLASS**



Smooth

S289\_

2'8" x 6'8"  
2'10" x 6'8"  
3'0" x 6'8"

**CLEAR GLASS WITH  
DIVIDED LITES**



Smooth

S807

2'8" x 6'8"  
2'10" x 6'8"  
3'0" x 6'8"



Smooth

S1411

2'8" x 6'8"  
2'10" x 6'8"  
3'0" x 6'8"

**CLEAR GLASS**



Smooth

S289

2'8" x 6'8"  
2'10" x 6'8"  
3'0" x 6'8"

**Privacy & Textured Glass Options**

Add the code to the blank in the style number for the desired door and glass combination. For details on glass options, see page 119.

XK = Reeded

XE = Satin Etch

XC = Chord

XJ = Chinchilla

XR = Rainglass

XN = Granite

Note: See page 285 for important product details that may help with your purchase decision.

Right Page: Smooth-Star, Salinas Glass, Door – S9353, Sidelites – S6008SL, Finish – Canyon

# Center Lites



## TRANSOMS

For transoms, see page 209.

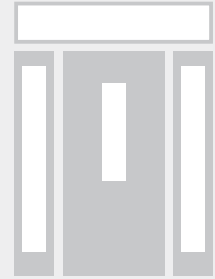

Fiber-Classic® & Smooth-Star®

### BLACKSTONE ♦ ♦

Oak	Oak	Smooth	Smooth
FC80943 6 2'8" x 6'8" 2'10" x 6'8" 3'0" x 6'8"	FC86243 6 2'8" x 8'0" 2'10" x 8'0" 3'0" x 8'0"	S9343 6 2'8" x 6'8" 2'10" x 6'8" 3'0" x 6'8"	S83143 6 2'8" x 8'0" 2'10" x 8'0" 3'0" x 8'0"

### SEDONA ♦ ♦

Oak	Oak	Smooth
FC80952 6 2'8" x 6'8" 2'10" x 6'8" 3'0" x 6'8"	FC86252 6 2'8" x 8'0" 2'10" x 8'0" 3'0" x 8'0"	S9352 6 2'8" x 6'8" 2'10" x 6'8" 3'0" x 6'8"

### SALINAS. X

Smooth	Oak	Oak	Smooth
S83152 6 2'8" x 8'0" 2'10" x 8'0" 3'0" x 8'0"	FC80953 6 2'8" x 6'8" 2'10" x 6'8" 3'0" x 6'8"	FC86253 6 2'8" x 8'0" 2'10" x 8'0" 3'0" x 8'0"	S9353 6 2'8" x 6'8" 2'10" x 6'8" 3'0" x 6'8"

### MAPLE PARK. ♦ ♦

Oak	Oak
FC80955 6 2'8" x 6'8" 2'10" x 6'8" 3'0" x 6'8"	FC86255 6 2'8" x 8'0" 2'10" x 8'0" 3'0" x 8'0"

### Key

- ☀ Low-E Glass (LE)
- ◆ Black Nickel Caming (1D)
- ▣ Brushed Nickel Caming (1C)
- ◆ Brass Caming (1A)
- ✗ Wrought Iron (1W)
- ▣ Scrolled & Flat Advanta Lite Frame  
Not available for 2'4" and 2'6" doors or 10" sidelites.
- ▣ Scrolled Advanta Lite Frame  
Not available for 2'4" and 2'6" doors or 10" sidelites.
- ▣ Simulated Divided Lites (SDL)
- ◆ Flat or Contour White Grilles Between Glass (GBGF / GBGC)
- ◆ Flat Almond Grilles Between Glass (GBGF)
- ◆ Flat Bronze Grilles Between Glass (GBGF)
- ◆ Flat or Contour Black Grilles Between Glass (GBGF / GBGC)
- ◆ Fixed Grilles (FXG)

### MAPLE PARK. ◆ ◆ ◆



**S9355**  
 2'8" x 6'8"  
 2'10" x 6'8"  
 3'0" x 6'8"

**S83155**  
 2'8" x 8'0"  
 2'10" x 8'0"  
 3'0" x 8'0"

### SARATOGA.™ ◆ ◆ ◆



**FC80954**  
 2'8" x 6'8"  
 2'10" x 6'8"  
 3'0" x 6'8"

**FC86254**  
 2'8" x 8'0"  
 2'10" x 8'0"  
 3'0" x 8'0"

**S9354**  
 2'8" x 6'8"  
 2'10" x 6'8"  
 3'0" x 6'8"

**S83154**  
 2'8" x 8'0"  
 2'10" x 8'0"  
 3'0" x 8'0"

### WELLESLEY.™ ◆ ◆ ◆ ◆



**FC80949**  
 2'8" x 6'8"  
 2'10" x 6'8"  
 3'0" x 6'8"

**FC86249**  
 2'8" x 8'0"  
 2'10" x 8'0"  
 3'0" x 8'0"

**S9349**  
 2'8" x 6'8"  
 2'10" x 6'8"  
 3'0" x 6'8"

**S83149**  
 2'8" x 8'0"  
 2'10" x 8'0"  
 3'0" x 8'0"

### RISERVA. ✕

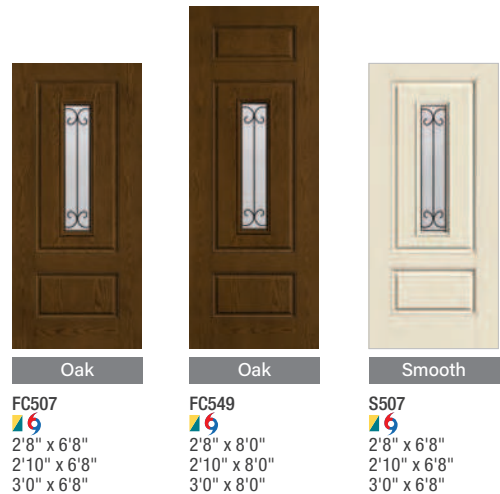

**FC507**  
 2'8" x 6'8"  
 2'10" x 6'8"  
 3'0" x 6'8"

**FC549**  
 2'8" x 8'0"  
 2'10" x 8'0"  
 3'0" x 8'0"

**S507**  
 2'8" x 6'8"  
 2'10" x 6'8"  
 3'0" x 6'8"

### CONCORDE.™ ◆ ◆ ◆ ◆



**S549**  
 2'8" x 8'0"  
 2'10" x 8'0"  
 3'0" x 8'0"

**FC80947**  
 2'8" x 6'8"  
 2'10" x 6'8"  
 3'0" x 6'8"

**FC86247**  
 2'8" x 8'0"  
 2'10" x 8'0"  
 3'0" x 8'0"

**S9347**  
 2'8" x 6'8"  
 2'10" x 6'8"  
 3'0" x 6'8"

**S83147**  
 2'8" x 8'0"  
 2'10" x 8'0"  
 3'0" x 8'0"

### KENSINGTON.™ ◆ ◆ ◆



**FC80942**  
 2'8" x 6'8"  
 2'10" x 6'8"  
 3'0" x 6'8"

**FC86242**  
 2'8" x 8'0"  
 2'10" x 8'0"  
 3'0" x 8'0"

#### Privacy & Textured Glass Options

Add the code to the blank in the style number for the desired door and glass combination. For details on glass options, see page 119.

XK = Reeded    XC = Chord    XR = Rainglass  
 XE = Satin Etch    XJ = Chinchilla    XN = Granite

**PEMBRIDGE™** ◆ ◆ ◆



Smooth

S9342  
 ◆ ◆  
 2'8" x 6'8"  
 2'10" x 6'8"  
 3'0" x 6'8"



Smooth

S83142  
 ◆ ◆  
 2'8" x 8'0"  
 2'10" x 8'0"  
 3'0" x 8'0"



Oak

FC6534  
 ◆ ◆  
 2'8" x 6'8"  
 2'10" x 6'8"  
 3'0" x 6'8"



Oak

FC86533  
 ◆ ◆  
 2'8" x 8'0"  
 2'10" x 8'0"  
 3'0" x 8'0"



Smooth

S6534  
 ◆ ◆  
 2'8" x 6'8"  
 2'10" x 6'8"  
 3'0" x 6'8"



Smooth

S86533  
 ◆ ◆  
 2'8" x 8'0"  
 2'10" x 8'0"  
 3'0" x 8'0"

**AXIS. ◆**



Oak

FC1655  
 ◆ ◆  
 2'8" x 6'8"  
 2'10" x 6'8"  
 3'0" x 6'8"



Oak

FC81649  
 ◆ ◆  
 2'8" x 8'0"  
 2'10" x 8'0"  
 3'0" x 8'0"



Smooth

S1655  
 ◆ ◆  
 2'8" x 6'8"  
 2'10" x 6'8"  
 3'0" x 6'8"



Smooth

S81649  
 ◆ ◆  
 2'8" x 8'0"  
 2'10" x 8'0"  
 3'0" x 8'0"



Oak

FC393  
 ◆ ◆  
 2'8" x 6'8"  
 2'10" x 6'8"  
 3'0" x 6'8"



Oak

FC8390  
 ◆ ◆  
 2'8" x 8'0"  
 2'10" x 8'0"  
 3'0" x 8'0"



Smooth

S393  
 ◆ ◆  
 2'8" x 6'8"  
 2'10" x 6'8"  
 3'0" x 6'8"

**CALIX ◆ ◆ ◆**

**PRIVACY & TEXTURED GLASS WITH DIVIDED LITES**



Smooth

S8390  
 ◆ ◆  
 2'8" x 8'0"  
 2'10" x 8'0"  
 3'0" x 8'0"



Oak

FC809203  
 ◆ ◆  
 2'8" x 6'8"  
 2'10" x 6'8"  
 3'0" x 6'8"



Oak

FC862203  
 ◆ ◆  
 2'8" x 8'0"  
 2'10" x 8'0"  
 3'0" x 8'0"



Smooth

S93203  
 ◆ ◆  
 2'8" x 6'8"  
 2'10" x 6'8"  
 3'0" x 6'8"



Smooth

S831203  
 ◆ ◆  
 2'8" x 8'0"  
 2'10" x 8'0"  
 3'0" x 8'0"

**Key**

- ◆ Black Nickel Caming (1D)
- ◆ Brushed Nickel Caming (1C)
- ◆ Brass Caming (1A)

- ✕ Wrought Iron (1W)

- ◆ Scrolled & Flat Advanta Lite Frame  
 Not available for 2'4" and 2'6" doors or 10" sidelites.

- 6 WBDP / HVHZ Options

## PRIVACY & TEXTURED GLASS

			
Oak	Oak	Smooth	Smooth
FC80920_	FC86220_	S9320_	S83120_
2'8" x 6'8" 2'10" x 6'8" 3'0" x 6'8"	2'8" x 8'0" 2'10" x 8'0" 3'0" x 8'0"	2'8" x 6'8" 2'10" x 6'8" 3'0" x 6'8"	2'8" x 8'0" 2'10" x 8'0" 3'0" x 8'0"

## INTERNAL BLINDS

		
Oak	Oak	Smooth
FC925	FC8972	S925
2'8" x 6'8" 2'10" x 6'8" 3'0" x 6'8"	2'8" x 8'0" 2'10" x 8'0" 3'0" x 8'0"	2'8" x 6'8" 2'10" x 6'8" 3'0" x 6'8"

## CLEAR GLASS WITH DIVIDED LITES

						
Smooth	Oak	Oak	Smooth	Smooth	Oak	Oak
S8972	FC809203	FC862203	S93203	S831203	FC1404	FC8141
2'8" x 8'0" 2'10" x 8'0" 3'0" x 8'0"	2'8" x 6'8" 2'10" x 6'8" 3'0" x 6'8"	2'8" x 8'0" 2'10" x 8'0" 3'0" x 8'0"	2'8" x 6'8" 2'10" x 6'8" 3'0" x 6'8"	2'8" x 8'0" 2'10" x 8'0" 3'0" x 8'0"	2'8" x 6'8" 2'10" x 6'8" 3'0" x 6'8"	2'8" x 8'0" 2'10" x 8'0" 3'0" x 8'0"

## CLEAR GLASS

					
Smooth	Smooth	Oak	Oak	Smooth	Smooth
S1404	S8141	FC80920	FC86220	S9320	S83120
2'8" x 6'8" 2'10" x 6'8" 3'0" x 6'8"	2'8" x 8'0" 2'10" x 8'0" 3'0" x 8'0"	2'8" x 6'8" 2'10" x 6'8" 3'0" x 6'8"	2'8" x 8'0" 2'10" x 8'0" 3'0" x 8'0"	2'8" x 6'8" 2'10" x 6'8" 3'0" x 6'8"	2'8" x 8'0" 2'10" x 8'0" 3'0" x 8'0"

### Privacy & Textured Glass Options

Add the code to the blank in the style number for the desired door and glass combination. For details on glass options, see page 119.

XE = Satin Etch    XJ = Chinchilla    XN = Granite  
XC = Chord        XR = Rainglass

\*Not recommended for use behind storm doors or to be painted dark colors, if exposed to direct sunlight.

\*\*Available with flat lite frame or Advanta flat lite frame only.

\*\*\*Available with flat lite frame, Advanta flat lite frame or Impact-rated lite frame only.

Note: See page 285 for important product details that may help with your purchase decision.

# Craftsman Lites



## TRANSOMS

For transoms, see page 209.

### OPTIONAL DENTIL SHELVES\*



**4-Block Dentil Shelf**  
Available for all Craftsman-lite  
Fiber-Classic Mahogany Collection doors.



**4-Block Dentil Shelf**  
Available for all Craftsman-lite  
Smooth-Star doors.

Fiber-Classic® & Smooth-Star®

## SEDONA ◆ ◆

		
Smooth	Mahogany	Smooth
<b>S2650**</b> LE E	<b>S82650**</b> LE E	<b>FCM604</b> 6
2'8" x 6'8" 2'10" x 6'8" 3'0" x 6'8"	2'8" x 8'0" 2'10" x 8'0" 3'0" x 8'0"	2'8" x 6'8" 2'10" x 6'8" 3'0" x 6'8"
<b>S604</b> 6	<b>S8604</b> 6	
2'8" x 6'8" 2'10" x 6'8" 3'0" x 6'8"	2'8" x 8'0" 2'10" x 8'0" 3'0" x 8'0"	

## MAPLE PARK ◆ ◆

		
Smooth	Mahogany	Smooth
<b>S2630***</b> LE E	<b>S82630***</b> LE E	<b>FCM609</b> 6
2'8" x 6'8" 2'10" x 6'8" 3'0" x 6'8"	2'8" x 8'0" 2'10" x 8'0" 3'0" x 8'0"	2'8" x 6'8" 2'10" x 6'8" 3'0" x 6'8"
<b>S609</b> 6	<b>S8609</b> 6	
2'8" x 6'8" 2'10" x 6'8" 3'0" x 6'8"	2'8" x 8'0" 2'10" x 8'0" 3'0" x 8'0"	

## SARATOGA ◆ ◆

		
Mahogany	Smooth	Smooth
<b>FCM602</b> 6	<b>S2660***</b> LE E	<b>S82660***</b> LE E
2'8" x 6'8" 2'10" x 6'8" 3'0" x 6'8"	2'8" x 6'8" 2'10" x 6'8" 3'0" x 6'8"	2'8" x 8'0" 2'10" x 8'0" 3'0" x 8'0"
<b>S602</b> 6	<b>S8602</b> 6	
2'8" x 6'8" 2'10" x 6'8" 3'0" x 6'8"	2'8" x 8'0" 2'10" x 8'0" 3'0" x 8'0"	

## RISERVA ✕

	
Mahogany	Smooth
<b>FCM508</b> 6	<b>S2670***</b> LE E
2'8" x 6'8" 2'10" x 6'8" 3'0" x 6'8"	2'8" x 6'8" 2'10" x 6'8" 3'0" x 6'8"
	<b>S82670***</b> LE E
	2'8" x 8'0" 2'10" x 8'0" 3'0" x 8'0"

**RISERVA** Continues on next page.

### Key

- ☀ Low-E Glass (LE)
- ◆ Black Nickel Caming (1D)
- ◆◆ Brushed Nickel Caming (1C)
- ◆◆ Brass Caming (1A)
- 🏠 Simulated Divided Lites (SDL)
- ◆ Flat or Contour White Grilles Between Glass (GBGF / GBGC)
- ◆ Flat Almond Grilles Between Glass (GBGF)
- ◆ Flat Bronze Grilles Between Glass (GBGF)
- ◆ Flat or Contour Black Grilles Between Glass (GBGF / GBGC)
- ◆ Fixed Grilles (FXG)
- 🏠 Scrolled & Flat Advanta Lite Frame  
Not available for 2'4" and 2'6" doors or 10" sidelites.
- 🏠 Scrolled Advanta Lite Frame  
Not available for 2'4" and 2'6" doors or 10" sidelites.
- 🏠 Flat Advanta Lite Frame  
Not available for 2'4" and 2'6" doors or 10" sidelites.
- 🏠 Flat Lite Frame
- 🏠 WBDL / HVHZ Options

**RISERVA** X Continued



Smooth

<b>S508</b> 2'8" x 6'8" 2'10" x 6'8" 3'0" x 6'8"	<b>S8508</b> 2'8" x 8'0" 2'10" x 8'0" 3'0" x 8'0"
---	--

**PEMBRIDGE** ♦ ♦ ♦ ♦



Mahogany

**FCM6520**  
2'8" x 6'8"  
2'10" x 6'8"  
3'0" x 6'8"



Smooth

<b>S2640*</b> 2'8" x 6'8" 2'10" x 6'8" 3'0" x 6'8"	<b>S82640*</b> 2'8" x 8'0" 2'10" x 8'0" 3'0" x 8'0"
---	--



Smooth

<b>S6520</b> 2'8" x 6'8" 2'10" x 6'8" 3'0" x 6'8"	<b>S86520</b> 2'8" x 8'0" 2'10" x 8'0" 3'0" x 8'0"
--	---

**AXIS** ♦



Mahogany

**FCM1650**  
2'8" x 6'8"  
2'10" x 6'8"  
3'0" x 6'8"

**CALIX** ♦ ♦ ♦ ♦



Smooth

<b>S2620*</b> 2'8" x 6'8" 2'10" x 6'8" 3'0" x 6'8"	<b>S82620*</b> 2'8" x 8'0" 2'10" x 8'0" 3'0" x 8'0"
---	--



Smooth

<b>S1650</b> 2'8" x 6'8" 2'10" x 6'8" 3'0" x 6'8"	<b>S81650</b> 2'8" x 8'0" 2'10" x 8'0" 3'0" x 8'0"
--	---



Mahogany

**FCM6975**  
2'8" x 6'8"  
2'10" x 6'8"  
3'0" x 6'8"

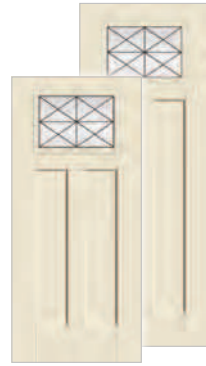

Smooth

<b>S3540*</b> 2'8" x 6'8" 2'10" x 6'8" 3'0" x 6'8"	<b>S83540*</b> 2'8" x 8'0" 2'10" x 8'0" 3'0" x 8'0"
---	--

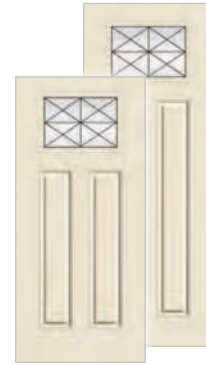

Smooth

<b>S6975</b> 2'8" x 6'8" 2'10" x 6'8" 3'0" x 6'8"	<b>S86975</b> 2'8" x 8'0" 2'10" x 8'0" 3'0" x 8'0"
--	---

**PRIVACY & TEXTURED GLASS WITH DIVIDED LITES**



Mahogany

**FCM605**  
2'8" x 6'8"  
2'10" x 6'8"  
3'0" x 6'8"



Mahogany

**FCM606**  
2'8" x 6'8"  
2'10" x 6'8"  
3'0" x 6'8"



Mahogany

**FCM607**  
2'8" x 6'8"  
2'10" x 6'8"  
3'0" x 6'8"



Mahogany

**FCM608**  
2'8" x 6'8"  
2'10" x 6'8"  
3'0" x 6'8"



Smooth

<b>S605</b> 2'8" x 6'8" 2'10" x 6'8" 3'0" x 6'8"	<b>S8605</b> 2'8" x 8'0" 2'10" x 8'0" 3'0" x 8'0"
---	--



Smooth

<b>S606</b> 2'8" x 6'8" 2'10" x 6'8" 3'0" x 6'8"	<b>S8606</b> 2'8" x 8'0" 2'10" x 8'0" 3'0" x 8'0"
---	--

**Privacy & Textured Glass Options**

Add the code to the blank in the style number for the desired door and glass combination. For details on glass options, see page 119.

**XE = Satin Etch**  
**XC = Chord**

**XJ = Chinchilla**  
**XR = Rainglass**

**XN = Granite**





\*Available with flat lite frame, Advanta flat lite frame or Impact-rated lite frame only.  
Note: See page 285 for important product details that may help with your purchase decision.



### PRIVACY & TEXTURED GLASS



**Smooth**

<b>S607</b> 	<b>S8607</b> 	<b>S608</b> 	<b>S8608</b> 
2'8" x 6'8"	2'8" x 8'0"	2'8" x 6'8"	2'8" x 8'0"
2'10" x 6'8"	2'10" x 8'0"	2'10" x 6'8"	2'10" x 8'0"
3'0" x 6'8"	3'0" x 8'0"	3'0" x 6'8"	3'0" x 8'0"





**Mahogany**      **Smooth**      **Smooth**

<b>FCM601</b> 	<b>S2610</b>  *	<b>S82610</b>  *	<b>S601</b> 	<b>S8601</b> 
2'8" x 6'8"	2'8" x 6'8"	2'8" x 8'0"	2'8" x 6'8"	2'8" x 8'0"
2'10" x 6'8"	2'10" x 6'8"	2'10" x 8'0"	2'10" x 6'8"	2'10" x 8'0"
3'0" x 6'8"	3'0" x 6'8"	3'0" x 8'0"	3'0" x 6'8"	3'0" x 8'0"

### CLEAR GLASS WITH DIVIDED LITES



**Mahogany**      **Mahogany**      **Mahogany**

<b>FCM605</b> 	<b>FCM606</b> 	<b>FCM607</b> 
2'8" x 6'8"	2'8" x 6'8"	2'8" x 6'8"
2'10" x 6'8"	2'10" x 6'8"	2'10" x 6'8"
3'0" x 6'8"	3'0" x 6'8"	3'0" x 6'8"



**Mahogany**      **Smooth**      **Smooth**

<b>FCM608</b> 	<b>S605</b> 	<b>S8605</b> 	<b>S606</b> 	<b>S8606</b> 
2'8" x 6'8"	2'8" x 6'8"	2'8" x 8'0"	2'8" x 6'8"	2'8" x 8'0"
2'10" x 6'8"	2'10" x 6'8"	2'10" x 8'0"	2'10" x 6'8"	2'10" x 8'0"
3'0" x 6'8"	3'0" x 6'8"	3'0" x 8'0"	3'0" x 6'8"	3'0" x 8'0"

### CLEAR GLASS







**Smooth**      **Smooth**













<b>S607</b> 	<b>S8607</b> 	<b>S608</b> 	<b>S8608</b> 
2'8" x 6'8"	2'8" x 8'0"	2'8" x 6'8"	2'8" x 8'0"
2'10" x 6'8"	2'10" x 8'0"	2'10" x 6'8"	2'10" x 8'0"
3'0" x 6'8"	3'0" x 8'0"	3'0" x 6'8"	3'0" x 8'0"



**Mahogany**      **Smooth**      **Smooth**

<b>FCM601</b> 	<b>S2610</b>  *	<b>S82610</b>  *	<b>S601</b> 	<b>S8601</b> 
2'8" x 6'8"	2'8" x 6'8"	2'8" x 8'0"	2'8" x 6'8"	2'8" x 8'0"
2'10" x 6'8"	2'10" x 6'8"	2'10" x 8'0"	2'10" x 6'8"	2'10" x 8'0"
3'0" x 6'8"	3'0" x 6'8"	3'0" x 8'0"	3'0" x 6'8"	3'0" x 8'0"

#### Key

-  Black Nickel Caming (1D)
-  Brushed Nickel Caming (1C)
-  Brass Caming (1A)
-  Wrought Iron (1W)
-  Simulated Divided Lites (SDL)
-  Flat Lite Frame
-  Scrolled & Flat Advanta Lite Frame  
Not available for 2'4" and 2'6" doors or 10" sidelites.
-  Scrolled Advanta Lite Frame  
Not available for 2'4" and 2'6" doors or 10" sidelites.
-  Flat Advanta Lite Frame  
Not available for 2'4" and 2'6" doors or 10" sidelites.
-  WBDR Options
-  WBDR / HVHZ Options
-  Elevated 10" Bottom Rail Options

# Minimal Lites



## TRANSOMS

For transoms, see page 209.

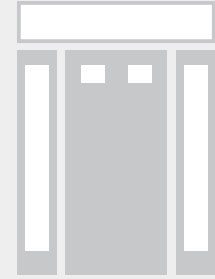

### MAPLE PARK. ♦ ♦



Mahogany

<b>FCM736</b>	<b>FCM8736</b>
2'8" x 6'8"	2'8" x 8'0"
2'10" x 6'8"	2'10" x 8'0"
3'0" x 6'8"	3'0" x 8'0"



Oak

<b>FC736</b>	<b>FC8736</b>
2'8" x 6'8" (7'0")	2'8" x 8'0"
2'10" x 6'8" (7'0")	2'10" x 8'0"
3'0" x 6'8" (7'0")	3'0" x 8'0"



Smooth

<b>S736</b>	<b>S8736</b>
<b>E</b>	2'8" x 8'0"
2'8" x 6'8" (7'0")	2'10" x 8'0"
2'10" x 6'8" (7'0")	3'0" x 8'0"
3'0" x 6'8" (7'0")	

### SARATOGA.™ ♦ ♦



Mahogany

<b>FCM707</b>	<b>FCM8707</b>
2'8" x 6'8"	2'8" x 8'0"
2'10" x 6'8"	2'10" x 8'0"
3'0" x 6'8"	3'0" x 8'0"



Oak

<b>FC707</b>	<b>FC8707</b>
2'8" x 6'8" (7'0")	2'8" x 8'0"
2'10" x 6'8" (7'0")	2'10" x 8'0"
3'0" x 6'8" (7'0")	3'0" x 8'0"

### WELLESLEY.™ ♦ ♦ ♦



Smooth

<b>S707</b>	<b>S8707</b>
<b>E</b>	2'8" x 8'0"
2'8" x 6'8" (7'0")	2'10" x 8'0"
2'10" x 6'8" (7'0")	3'0" x 8'0"
3'0" x 6'8" (7'0")	



Mahogany

<b>FCM721</b>	<b>FCM8721</b>
2'8" x 6'8"	2'8" x 8'0"
2'10" x 6'8"	2'10" x 8'0"
3'0" x 6'8"	3'0" x 8'0"



Oak

<b>FC721</b>	<b>FC8721</b>
2'8" x 6'8" (7'0")	2'8" x 8'0"
2'10" x 6'8" (7'0")	2'10" x 8'0"
3'0" x 6'8" (7'0")	3'0" x 8'0"



Smooth

<b>S721</b>	<b>S8721</b>
<b>E</b>	2'8" x 8'0"
2'8" x 6'8" (7'0")	2'10" x 8'0"
2'10" x 6'8" (7'0")	3'0" x 8'0"
3'0" x 6'8" (7'0")	

Note: See page 285 for important product details that may help with your purchase decision.

Top: Smooth-Star, Wellesley Glass, Door - S721

**CONCORDE™** ◆ ◆ ◆



Mahogany

FCM735	FCM8735
2'8" x 6'8"	2'8" x 8'0"
2'10" x 6'8"	2'10" x 8'0"
3'0" x 6'8"	3'0" x 8'0"



Oak

FC735	FC8735
2'8" x 6'8" (7'0")	2'8" x 8'0"
2'10" x 6'8" (7'0")	2'10" x 8'0"
3'0" x 6'8" (7'0")	3'0" x 8'0"



Smooth

S735	S8735
<b>E</b>	2'8" x 8'0"
2'8" x 6'8" (7'0")	2'10" x 8'0"
2'10" x 6'8" (7'0")	3'0" x 8'0"
3'0" x 6'8" (7'0")	

**PEMBRIDGE™** ◆ ◆ ◆



Mahogany

FCM745	FCM8745
2'8" x 6'8"	2'8" x 8'0"
2'10" x 6'8"	2'10" x 8'0"
3'0" x 6'8"	3'0" x 8'0"



Oak

FC745	FC8745
2'8" x 6'8" (7'0")	2'8" x 8'0"
2'10" x 6'8" (7'0")	2'10" x 8'0"
3'0" x 6'8" (7'0")	3'0" x 8'0"

**CLEAR GLASS WITH DIVIDED LITES**



Smooth

S745	S8745
<b>E</b>	2'8" x 8'0"
2'8" x 6'8" (7'0")	2'10" x 8'0"
2'10" x 6'8" (7'0")	3'0" x 8'0"
3'0" x 6'8" (7'0")	



Mahogany

FCM752	FCM8752
◆◆◆◆◆	◆◆◆◆◆
2'8" x 6'8"	2'8" x 8'0"
2'10" x 6'8"	2'10" x 8'0"
3'0" x 6'8"	3'0" x 8'0"



Oak

FC752	FC8752
◆◆◆◆◆	◆◆◆◆◆
2'8" x 6'8" (7'0")	2'8" x 8'0"
2'10" x 6'8" (7'0")	2'10" x 8'0"
3'0" x 6'8" (7'0")	3'0" x 8'0"



Smooth

S752	S8752
◆◆◆◆◆ <b>E</b>	◆◆◆◆◆
2'8" x 6'8" (7'0")	2'8" x 8'0"
2'10" x 6'8" (7'0")	2'10" x 8'0"
3'0" x 6'8" (7'0")	3'0" x 8'0"



Mahogany

FCM704	FCM8704
◆◆	◆◆
2'8" x 6'8"	2'8" x 8'0"
2'10" x 6'8"	2'10" x 8'0"
3'0" x 6'8"	3'0" x 8'0"

**CLEAR GLASS**



Oak

FC704	FC8704
◆◆	◆◆
2'8" x 6'8" (7'0")	2'8" x 8'0"
2'10" x 6'8" (7'0")	2'10" x 8'0"
3'0" x 6'8" (7'0")	3'0" x 8'0"



Smooth

S704	S8704
◆◆ <b>E</b>	◆◆
2'8" x 6'8" (7'0")	2'8" x 8'0"
2'10" x 6'8" (7'0")	2'10" x 8'0"
3'0" x 6'8" (7'0")	3'0" x 8'0"



Mahogany

FCM708	FCM8708
◆	◆
2'8" x 6'8"	2'8" x 8'0"
2'10" x 6'8"	2'10" x 8'0"
3'0" x 6'8"	3'0" x 8'0"



Oak

FC708	FC8708
◆	◆
2'8" x 6'8" (7'0")	2'8" x 8'0"
2'10" x 6'8" (7'0")	2'10" x 8'0"
3'0" x 6'8" (7'0")	3'0" x 8'0"



Smooth

S708	S8708
◆ <b>E</b>	◆
2'8" x 6'8" (7'0")	2'8" x 8'0"
2'10" x 6'8" (7'0")	2'10" x 8'0"
3'0" x 6'8" (7'0")	3'0" x 8'0"

**Key**

◆ Low-E Glass (LE)  
 ◆ Black Nickel Caming (1D)  
 ■ Brushed Nickel Caming (1C)

◆ Brass Caming (1A)  
 ◆ Simulated Divided Lites (SDL)  
 ◆ Flat Lite Frame

◆ Scrolled & Flat Advanta Lite Frame  
 Not available for 2'4" and 2'6" doors or 10" sidelites.

◆ Scrolled Advanta Lite Frame  
 Not available for 2'4" and 2'6" doors or 10" sidelites.  
 ◆ Flat Advanta Lite Frame  
 Not available for 2'4" and 2'6" doors or 10" sidelites.

6 WBDR Options  
 6 WBDR / HVHZ Options  
**E** Elevated 10" Bottom Rail Options

**CONCORDE™** ♦ ♦ ♦



Oak

**FC917**  
2'8" x 6'8"  
2'10" x 6'8"  
3'0" x 6'8"



Smooth

**S454**  
2'8" x 6'8"  
2'10" x 6'8"  
3'0" x 6'8"

**CLEAR GLASS WITH DIVIDED LITES**



Oak

**FC23**  
♦ ♦ ♦ ♦ ♦  
2'8" x 6'8"  
2'10" x 6'8"  
3'0" x 6'8"



Smooth

**S255**  
♦ ♦ ♦ ♦ ♦  
2'8" x 6'8"  
2'10" x 6'8"  
3'0" x 6'8"

**CLEAR GLASS**



Oak

**FC803**  
♦  
2'8" x 6'8"  
2'10" x 6'8"  
3'0" x 6'8"



Smooth

**S256**  
♦  
2'8" x 6'8"  
2'10" x 6'8"  
3'0" x 6'8"

**CLEAR GLASS WITH DIVIDED LITES**



Smooth

**S236**  
♦ ♦ ♦ ♦ ♦  
2'8" x 6'8"  
2'10" x 6'8"  
3'0" x 6'8"



Smooth

**S8317**  
♦ ♦ ♦ ♦ ♦  
2'8" x 8'0"  
2'10" x 8'0"  
3'0" x 8'0"

**S237**  
♦ ♦ ♦ ♦ ♦  
2'8" x 6'8"  
2'10" x 6'8"  
3'0" x 6'8"  
(Scalloped Lite Frame)

**PEMBRIDGE™** ♦ ♦ ♦



Mahogany

**FCM6570**  
♦ ♦ ♦ ♦ ♦  
2'8" x 6'8"  
2'10" x 6'8"  
3'0" x 6'8"

**FCM86570**  
♦ ♦ ♦ ♦ ♦  
2'8" x 8'0"  
2'10" x 8'0"  
3'0" x 8'0"



Oak

**FC6570**  
♦ ♦ ♦ ♦ ♦  
2'6" x 6'8" (7'0")  
2'8" x 6'8" (7'0")  
2'10" x 6'8" (7'0")  
3'0" x 6'8" (7'0")

**FC86570**  
♦ ♦ ♦ ♦ ♦  
2'8" x 8'0"  
2'10" x 8'0"  
3'0" x 8'0"



Smooth

**S6570**  
♦ ♦ ♦ ♦ ♦  
2'6" x 6'8"  
2'8" x 6'8" (7'0")  
2'10" x 6'8" (7'0")  
3'0" x 6'8" (7'0")

**S86570**  
♦ ♦ ♦ ♦ ♦  
2'6" x 8'0"  
2'8" x 8'0"  
2'10" x 8'0"  
3'0" x 8'0"

**AXIS®** ♦



Mahogany

**FCM1645**  
♦ ♦ ♦ ♦ ♦  
2'8" x 6'8"  
2'10" x 6'8"  
3'0" x 6'8"

**FCM81645**  
♦ ♦ ♦ ♦ ♦  
2'8" x 8'0"  
2'10" x 8'0"  
3'0" x 8'0"



Oak

**FC1645**  
♦ ♦ ♦ ♦ ♦  
2'6" x 6'8" (7'0")  
2'8" x 6'8" (7'0")  
2'10" x 6'8" (7'0")  
3'0" x 6'8" (7'0")

**FC81645**  
♦ ♦ ♦ ♦ ♦  
2'8" x 8'0"  
2'10" x 8'0"  
3'0" x 8'0"



Smooth

**S1645**  
♦ ♦ ♦ ♦ ♦  
2'6" x 6'8"  
2'8" x 6'8" (7'0")  
2'10" x 6'8" (7'0")  
3'0" x 6'8" (7'0")

**S81645**  
♦ ♦ ♦ ♦ ♦  
2'6" x 8'0"  
2'8" x 8'0"  
2'10" x 8'0"  
3'0" x 8'0"

**Privacy & Textured Glass Options**

Add the code to the blank in the style number for the desired door and glass combination. For details on glass options, see page 119.

XK = Reeded

XC = Chord

XR = Rainglass

XE = Satin Etch

XJ = Chinchilla

XN = Granite

Note: See page 285 for important product details that may help with your purchase decision.

Right Page: Smooth-Star, Clear Glass, Door – S296, Finish – Cypress

## PRIVACY & TEXTURED GLASS



Mahogany

<b>FCM61</b> ☀️ 2'8" x 6'8" 2'10" x 6'8" 3'0" x 6'8"	<b>FCM861</b> ☀️ 2'8" x 8'0" 2'10" x 8'0" 3'0" x 8'0"
--	---



Oak

<b>FC61</b> ☀️ 2'6" x 6'8" (7'0") 2'8" x 6'8" (7'0") 2'10" x 6'8" (7'0") 3'0" x 6'8" (7'0")	<b>FC861</b> ☀️ 2'8" x 8'0" 2'10" x 8'0" 3'0" x 8'0"
--	--



Smooth

<b>S296</b> ☀️ 2'6" x 6'8" 2'8" x 6'8" (7'0") 2'10" x 6'8" (7'0") 3'0" x 6'8" (7'0")	<b>S896</b> ☀️ 2'6" x 8'0" 2'8" x 8'0" 2'10" x 8'0" 3'0" x 8'0"
---	--

## CLEAR GLASS



Mahogany

<b>FCM61</b> ☀️ 2'8" x 6'8" 2'10" x 6'8" 3'0" x 6'8"	<b>FCM861</b> ☀️ 2'8" x 8'0" 2'10" x 8'0" 3'0" x 8'0"
--	---



Oak

<b>FC61</b> ☀️ 2'6" x 6'8" (7'0") 2'8" x 6'8" (7'0") 2'10" x 6'8" (7'0") 3'0" x 6'8" (7'0")	<b>FC861</b> ☀️ 2'8" x 8'0" 2'10" x 8'0" 3'0" x 8'0"
--	--



Smooth

<b>S296</b> ☀️ 2'6" x 6'8" 2'8" x 6'8" (7'0") 2'10" x 6'8" (7'0") 3'0" x 6'8" (7'0")	<b>S896</b> ☀️ 2'6" x 8'0" 2'8" x 8'0" 2'10" x 8'0" 3'0" x 8'0"
---	--

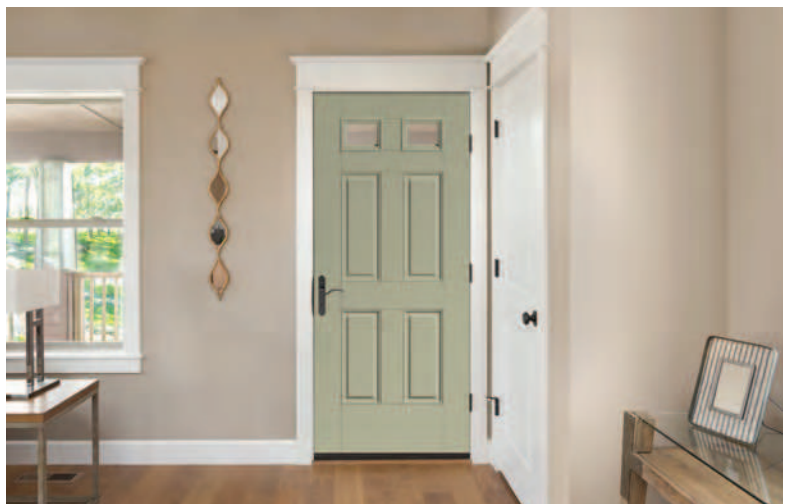

## Noise Reduction Doors

Therma-Tru® Noise Reduction doors deliver aesthetics with a commercial level of performance for residential projects. Ideal for multi-use and urban in-fill projects located near sources of noise pollution, our Noise Reduction doors provide a Sound Transmission Class (STC) rating of 36. Our Noise Reduction lites also offer added security from forced entry with laminated glass surrounded by a standard Lip-lite frame.

Note: Also available in decorative full-lite glass option in aluminum Lip-lite frame.



Smooth

<b>S140STC</b> ☀️ 2'6" x 6'8" (7'0") 2'8" x 6'8" (7'0") 2'10" x 6'8" (7'0") 3'0" x 6'8" (7'0")	<b>S8140STC</b> ☀️ 2'6" x 8'0" 2'8" x 8'0" 3'0" x 8'0"
---	--



Smooth

<b>S141STC</b> ☀️ 2'6" x 6'8" (7'0") 2'8" x 6'8" (7'0") 2'10" x 6'8" (7'0") 3'0" x 6'8" (7'0")
---



Smooth

<b>S6063STC</b> ☀️ 2'6" x 6'8" (7'0") 2'8" x 6'8" (7'0") 2'10" x 6'8" (7'0") 3'0" x 6'8" (7'0")
--

### Key

- No Stile Lines
- ☀️ Low-E Glass (LE)
- ◆ Black Nickel Caming (1D)
- Brushed Nickel Caming (1C)
- ◆ Brass Caming (1A)
- ◆ Flat or Contour White Grilles Between Glass (GBGF / GBGC)
- ◆ Flat Almond Grilles Between Glass (GBGF)
- ◆ Flat Bronze Grilles Between Glass (GBGF)
- ◆ Flat White Grilles Between Glass Only (GBGFW)
- ◆ Fixed Grilles (FXG)
- ◆ Scrolled & Flat Advanta Lite Frame  
Not available for 2'4" and 2'6" doors or 10" sidelites.
- Elevated 10" Bottom Rail Options

# Solid Panel



## TRANSOMS

For transoms, see page 209.

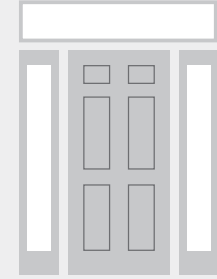

Mahogany  
FCM31  
2'8" x 6'8"  
2'10" x 6'8"  
3'0" x 6'8"

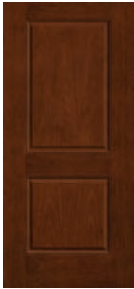

Mahogany  
FCM220  
2'8" x 6'8"  
2'10" x 6'8"  
3'0" x 6'8"



Mahogany  
FCM205  
2'8" x 6'8"  
2'10" x 6'8"  
3'0" x 6'8"



Mahogany  
FCM755  
2'8" x 6'8"  
2'10" x 6'8"  
3'0" x 6'8"



Mahogany  
FCM600  
2'8" x 6'8"  
2'10" x 6'8"  
3'0" x 6'8"



Mahogany  
FCM60  
2'8" x 6'8"  
2'10" x 6'8"  
3'0" x 6'8"



Mahogany  
FCM860  
2'8" x 8'0"  
2'10" x 8'0"  
3'0" x 8'0"



Mahogany  
FCM1000  
2'0" x 6'8"  
2'4" x 6'8"  
2'6" x 6'8" (7'0")  
2'8" x 6'8" (7'0")  
2'10" x 6'8" (7'0")  
3'0" x 6'8" (7'0")



Mahogany  
FCM81000  
2'0" x 8'0"  
2'4" x 8'0"  
2'6" x 8'0"  
2'8" x 8'0"  
2'10" x 8'0"  
3'0" x 8'0"



Oak  
FC31  
2'8" x 6'8"  
2'10" x 6'8"  
3'0" x 6'8"



Oak  
FC809  
2'8" x 6'8"  
2'10" x 6'8"  
3'0" x 6'8"



Oak  
FC755  
2'8" x 6'8"  
2'10" x 6'8"  
3'0" x 6'8"



Oak  
FC862  
2'8" x 8'0"  
2'10" x 8'0"  
3'0" x 8'0"



Oak  
FC60  
2'6" x 6'8" (7'0")  
2'8" x 6'8" (7'0")  
2'10" x 6'8" (7'0")  
3'0" x 6'8" (7'0")



Oak  
FC860  
2'8" x 8'0"  
2'10" x 8'0"  
3'0" x 8'0"

### Privacy & Textured Glass Options

Add the code to the blank in the style number for the desired door and glass combination. For details on glass options, see page 119.

XK = Reeded  
XE = Satin Etch

XC = Chord  
XJ = Chinchilla

XR = Rainglass  
XN = Granite

Note: See page 285 for important product details that may help with your purchase decision.

Top: Smooth-Star Door - S1100; Clear Glass, Sidelites - S2000SL, Finish - Granite



Oak

- |                       |                     |
|-----------------------|---------------------|
| <b>1000</b><br>■ 6 E  | <b>81000</b><br>■ 6 |
| 2'0" x 6'8"           | 2'0" x 8'0"         |
| 2'4" x 6'8" Δ         | 2'4" x 8'0"         |
| 2'6" x 6'8" Δ (7'0")  | 2'6" x 8'0"         |
| 2'8" x 6'8" Δ (7'0")  | 2'8" x 8'0"         |
| 2'10" x 6'8" Δ (7'0") | 2'10" x 8'0"        |
| 3'0" x 6'8" Δ (7'0")  | 3'0" x 8'0"         |



Smooth

- |                 |
|-----------------|
| <b>S93</b><br>6 |
| 2'8" x 6'8"     |
| 2'10" x 6'8"    |
| 3'0" x 6'8"     |



Smooth

- |                 |
|-----------------|
| <b>S45</b><br>6 |
| 2'8" x 6'8"     |
| 2'10" x 6'8"    |
| 3'0" x 6'8"     |



Smooth

- |                     |                     |
|---------------------|---------------------|
| <b>S220</b><br>6 E  | <b>S8200</b><br>6 E |
| 2'8" x 6'8" (7'0")  | 2'8" x 8'0"         |
| 2'10" x 6'8" (7'0") | 2'10" x 8'0"        |
| 3'0" x 6'8" (7'0")  | 3'0" x 8'0"         |



Smooth

- |                     |                    |
|---------------------|--------------------|
| <b>S1100</b><br>6 E | <b>S81100</b><br>6 |
| 2'8" x 6'8"         | 2'8" x 8'0"        |
| 2'10" x 6'8"        | 2'10" x 8'0"       |
| 3'0" x 6'8"         | 3'0" x 8'0"        |



NEW

NEW

Smooth

- |                       |                      |
|-----------------------|----------------------|
| <b>S3301</b><br>2 6 E | <b>S83301</b><br>2 6 |
| 2'8" x 6'8"           | 2'8" x 8'0"          |
| 2'10" x 6'8"          | 2'10" x 8'0"         |
| 3'0" x 6'8"           | 3'0" x 8'0"          |



NEW

NEW

Smooth

- |                       |                      |
|-----------------------|----------------------|
| <b>S3401</b><br>2 6 E | <b>S83401</b><br>2 6 |
| 2'8" x 6'8"           | 2'8" x 8'0"          |
| 2'10" x 6'8"          | 2'10" x 8'0"         |
| 3'0" x 6'8"           | 3'0" x 8'0"          |



NEW

NEW

Smooth

- |                       |                      |
|-----------------------|----------------------|
| <b>S3501</b><br>2 6 E | <b>S83501</b><br>2 6 |
| 2'8" x 6'8"           | 2'8" x 8'0"          |
| 2'10" x 6'8"          | 2'10" x 8'0"         |
| 3'0" x 6'8"           | 3'0" x 8'0"          |



NEW

NEW

Smooth

- |                       |                      |
|-----------------------|----------------------|
| <b>S3601</b><br>2 6 E | <b>S83601</b><br>2 6 |
| 2'8" x 6'8"           | 2'8" x 8'0"          |
| 2'10" x 6'8"          | 2'10" x 8'0"         |
| 3'0" x 6'8"           | 3'0" x 8'0"          |



NEW

NEW

Smooth

- |                       |                      |
|-----------------------|----------------------|
| <b>S5701</b><br>2 6 E | <b>S85701</b><br>2 6 |
| 2'8" x 6'8"           | 2'8" x 8'0"          |
| 2'10" x 6'8"          | 2'10" x 8'0"         |
| 3'0" x 6'8"           | 3'0" x 8'0"          |



NEW

NEW

Smooth

- |                       |                      |
|-----------------------|----------------------|
| <b>S5721</b><br>2 6 E | <b>S85721</b><br>2 6 |
| 2'8" x 6'8"           | 2'8" x 8'0"          |
| 2'10" x 6'8"          | 2'10" x 8'0"         |
| 3'0" x 6'8"           | 3'0" x 8'0"          |

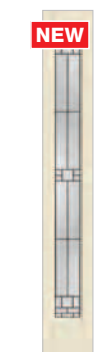

NEW

Smooth

- |                 |
|-----------------|
| <b>S85230SL</b> |
| ▲ E             |
| 12" x 8'0"      |
| 14" x 8'0"      |



Smooth SL

- |                  |
|------------------|
| <b>S85700_SL</b> |
| ▲ 2              |
| 12" x 8'0"       |
| 14" x 8'0"       |



Smooth SL

- |                  |
|------------------|
| <b>S85710_SL</b> |
| ▲ 2              |
| 12" x 8'0"       |
| 14" x 8'0"       |



Smooth SL

- |                  |
|------------------|
| <b>S85720_SL</b> |
| ▲ 2              |
| 12" x 8'0"       |
| 14" x 8'0"       |



Smooth SL

- |                 |
|-----------------|
| <b>S85700SL</b> |
| ▲ 2             |
| 12" x 8'0"      |
| 14" x 8'0"      |



Smooth SL

- |                 |
|-----------------|
| <b>S85710SL</b> |
| ▲ 2             |
| 12" x 8'0"      |
| 14" x 8'0"      |



Smooth SL







- |                 |
|-----------------|
| <b>S85720SL</b> |
| ▲ 2             |
| 12" x 8'0"      |
| 14" x 8'0"      |







Pair full-lite Shaker flush-glazed sidelites with solid-panel doors for natural light in the entry.

**Key**

- No Stile Lines
- ▲ Flush-Glazed Glass with Detailed Sticking (FG)
- ★ Low-E Glass (LE)
- 2 Door Divider Bars (DDBF2)
- 2 Simulated Divided Lites (SDF2)
- 6 WBDR Options
- 6 WBDR / HVHZ Options
- ▲ 6'6" Height Available
- E Elevated 10" Bottom Rail Options

**SOLID PANEL** *Continued*

					
<b>Smooth</b>	<b>Smooth</b>	<b>Smooth</b>	<b>Smooth</b>	<b>Smooth</b>	<b>Smooth</b>
<b>S120</b> 6E 2'8" x 6'8" 2'10" x 6'8" 3'0" x 6'8"	<b>S8120</b> 6E 2'8" x 8'0" 2'10" x 8'0" 3'0" x 8'0"	<b>S200</b> 6 2'6" x 6'8" 2'8" x 6'8" 2'10" x 6'8" 3'0" x 6'8"	<b>S897</b> 6 2'8" x 8'0" 2'10" x 8'0" 3'0" x 8'0"	<b>S205</b> 6 2'8" x 6'8" 2'10" x 6'8" 3'0" x 6'8"	<b>S8201</b> 6 2'8" x 8'0" 2'10" x 8'0" 3'0" x 8'0"
<b>S755</b> 6 2'8" x 6'8" 2'10" x 6'8" 3'0" x 6'8"	<b>S31</b> 6 2'8" x 6'8" 2'10" x 6'8" 3'0" x 6'8"	<b>S831</b> 6 2'8" x 8'0" 2'10" x 8'0" 3'0" x 8'0"			

								
<b>Smooth</b>	<b>Smooth</b>	<b>Smooth</b>	<b>Smooth</b>	<b>Smooth</b>	<b>Smooth</b>	<b>Smooth</b>	<b>Smooth</b>	<b>Smooth</b>
<b>S960</b> 6 2'8" x 6'8" 2'10" x 6'8" 3'0" x 6'8"	<b>S4800</b> 6E 2'8" x 6'8" 2'10" x 6'8" 3'0" x 6'8"	<b>S84800</b> 6 2'8" x 8'0" 2'10" x 8'0" 3'0" x 8'0"	<b>S600</b> 6 2'8" x 6'8" 2'10" x 6'8" 3'0" x 6'8"	<b>S8600</b> 6 2'8" x 8'0" 2'10" x 8'0" 3'0" x 8'0"	<b>S210</b> 6E 2'6" x 6'8" 2'8" x 6'8" (7'0") 2'10" x 6'8" (7'0") 3'0" x 6'8" (7'0")	<b>S810</b> 6 2'6" x 8'0" 2'8" x 8'0" 2'10" x 8'0" 3'0" x 8'0"	<b>S100</b> 6E 2'0" x 6'8" Δ 2'4" x 6'8" Δ 2'6" x 6'8" Δ 2'8" x 6'8" Δ (7'0") 2'10" x 6'8" Δ (7'0") 3'0" x 6'8" Δ (7'0") 3'6" x 6'8"	<b>S81000</b> 6 2'0" x 8'0" 2'4" x 8'0" 2'6" x 8'0" 2'8" x 8'0" 2'10" x 8'0" 3'0" x 8'0" 3'6" x 8'0"



Note: See page 285 for important product details that may help with your purchase decision.

Top: Impressions Storm & Entry Door System - IM100, Finish - Black; Fiber-Classic Mahogany Collection Door - FCM220; Calix Glass, Sidelites - FCM2389SL, Finish - Raven



# Transoms

Transoms can be stained or painted to match a Fiber-Classic® or Smooth-Star® door system.

## BLACKSTONE ◆ ⦿

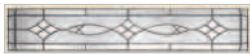

**BSRT**  
3'0" door + (2) 12" sidelites  
Continuous Sill Systems Only

## SEDONA ◆ ⦿

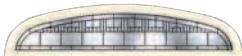

**19055T**  
3'0" door + (2) 12" sidelites  
3'0" door + (2) 14" sidelites  
Continuous Sill Systems Only



**19520T**  
3'0" door + (2) 12" sidelites  
3'0" door + (2) 14" sidelites  
Continuous Sill Systems Only

## SALINAS ✕



**SART**  
3'0" door + (2) 12" sidelites  
Continuous Sill Systems Only

## MAPLE PARK ◆ ⦿



**FWRT**  
3'0" door + (2) 12" sidelites  
3'0" door + (2) 14" sidelites  
Continuous Sill Systems Only

## SARATOGA ◆ ⦿



**19750T**  
3'0" door + (2) 12" sidelites  
Continuous Sill Systems Only



**19740T**  
3'0" Door Only

## WELLESLEY ◆ ⦿ ⦿



**19730T**  
3'0" door + (2) 12" sidelites  
Continuous Sill Systems Only



**19720T**  
3'0" Door Only

## RISERVA ✕

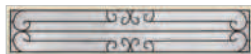

**RSRT**  
3'0" door + (2) 12" sidelites  
Continuous Sill Systems Only

## CONCORDE ◆ ⦿ ⦿



**CNRT**  
3'0" door + (2) 12" sidelites  
3'0" door + (2) 14" sidelites  
Continuous Sill Systems Only

## KENSINGTON ◆ ⦿



**KNRT**  
3'0" door + (2) 12" sidelites  
3'0" door + (2) 14" sidelites  
Continuous Sill Systems Only

## PEMBRIDGE ◆ ⦿ ⦿



**PBRT**  
3'0" door + (2) 12" sidelites  
3'0" door + (2) 14" sidelites  
Continuous / Boxed Sill Systems

## AXIS ◆



**AXRT**  
3'0" door + (2) 12" sidelites  
3'0" door + (2) 14" sidelites  
Continuous / Boxed Sill Systems

## CALIX ◆ ⦿ ⦿

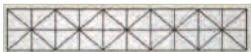

**CXRT**  
3'0" door + (2) 12" sidelites  
Continuous / Boxed Sill Systems



**CX30T**  
3'0" Door Only

## LATITUDE ◆ ⦿ ⦿



**LTRT**  
3'0" door + (2) 12" sidelites  
Continuous / Boxed Sill Systems

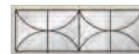

**LT30T**  
3'0" Door Only

## ECHELON ◆ ⦿ ⦿



**ECRT**  
3'0" door + (2) 12" sidelites  
Continuous / Boxed Sill Systems



**EC30T**  
3'0" Door Only

## CLEAR GLASS



Grille Sticks Applied



**19020T**  
★  
3'0" door + (2) 12" sidelites  
Continuous Sill Systems Only  
3'0" door + (2) 14" sidelites  
Continuous / Boxed Sill Systems



Grille Sticks Applied



**19220T**  
★  
3'0" door + (2) 12" sidelites  
3'0" door + (2) 14" sidelites  
Continuous / Boxed Sill Systems



Grille Sticks Applied



**19200T**  
★  
3'0" Door Only



**19210T**  
★  
12" & 14" Sidelite Only

### Key

- No Stile Lines
- ★ Low-E Glass (LE)
- ◆ Black Nickel Caming (1D)
- ⦿ Brushed Nickel Caming (1C)
- ✕ Brass Caming (1A)
- ✕ Wrought Iron (1W)
- 6 WBDR Options
- 6 WBDR / HVHZ Options
- ⚠ 6'6" Height Available
- E Elevated 10" Bottom Rail Options

# Hinged Patio Doors

Fiber-Classic®, Smooth-Star®, Profiles™ & Traditions

Hinged Patio Doors



## Flexible options for any home.

Our Fiber-Classic, Smooth-Star, Profiles and Traditions product lines extend to the patio with a wide assortment of options that combine form and function. Explore convenient options to control natural light and privacy, complement window grid patterns and more, all backed by Therma-Tru's outstanding warranties.



Note: Finish colors may vary from an actual application due to fluctuations in finishing or printing. See your Therma-Tru seller or visit [thermatru.com](http://thermatru.com) for details on limited warranties and exclusions, and ENERGY STAR qualified products.

Top: Smooth-Star, Clear Glass with SDLs, Doors – S85715, Finish – Alpine, Onyx  
Bottom: Smooth-Star, Clear Glass, Doors – S118

## DOOR SELECTIONS



**Fiber-Classic<sup>®</sup>  
Mahogany  
Collection™**



**Fiber-Classic<sup>®</sup>  
Oak Collection™**

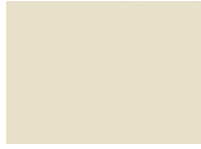

**Smooth-Star<sup>®</sup>**



**Profiles™  
& Traditions**

(Wood-grained images shown in Driftwood stain.)

## Retractable Screen Doors

With a discreet, hidden design, retractable screen doors allow fresh air and natural light inside while keeping debris and insects out. Available for single and french inswing configurations. See pages 30–31 for details.

## GLASS SELECTIONS



Internal Blinds

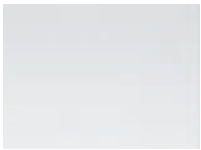

Low-E / Clear

### Divided Lites

For details on divided lite options, see pages 120–121.



Simulated  
Divided  
Lites



Grilles  
Between  
Glass



Fixed  
Grilles

## Flush-Glazed Glass

Glass built directly into the door during the manufacturing process offers a seamless appearance, wider daylight opening and high-performance weather seal.

## EnLiten™ Flush-Glazed Warranty Riders

See page 123 for details on the EnLiten Flush-Glazed Rider for Construction & Installation, and the EnLiten Flush-Glazed Rider for Homeowners.

■ = Available	Fiber-Classic.	Smooth-Star.	Profiles™	Traditions
<b>Door Selections</b>				
Material	Fiberglass	Fiberglass	Steel	Steel
Warranty	Lifetime	Lifetime	10 Years	Door: 5 Years Glass: 10 Years
Finish Options	Stain or Paint	Paint	Paint	Paint
<b>Flush-Glazed Glass Selections</b>				
Internal Blinds ▲	■	■		
Low-E Glass with and without Divided Lites ▲	■	■		
Clear Glass with and without Divided Lites ▲	■	■		
Privacy & Textured Glass with and without Divided Lites ▲	■	■		
<b>Lip-Lite Glass Selections</b>				
Internal Blinds	■	■	■	■
Low-E Glass with and without Divided Lites	■	■	■	■
Clear Glass with and without Divided Lites	■	■	■	■
Privacy & Textured Glass with and without Divided Lites	■	■	■	■
<b>Available Sizes</b>				
Heights	6'6", 6'8", 7'0", 8'0"	6'6", 6'8", 7'0", 8'0"	6'6", 6'8", 7'0"	6'6", 6'8", 8'0"
Single Widths	2'0"–3'0"	2'0"–3'0"	2'0"–3'0"	2'0"–3'0"
Double Widths	4'0"–6'0"	4'0"–6'0"	4'0"–6'0"	4'0"–6'0"
Triple Widths	6'0"–9'0"	6'0"–9'0"	6'0"–9'0"	6'0"–9'0"
Retrofit Openings	5'0", 6'0"	5'0", 6'0"	5'0", 6'0"	5'0", 6'0"
<b>Additional Options</b>				
Vented Sidelites (Single / Double Widths)	6'6", 6'8", 8'0" Heights in 2'4"–6'0" Widths	6'6", 6'8", 8'0" Heights in 2'4"–6'0" Widths		
Screens & Screen Accessories Available Colors: Bronze, White	2" Frame, 3" Frame	2" Frame, 3" Frame	2" Frame, 3" Frame	2" Frame, 3" Frame
Impact-Rated Options	■	■	■	■
Tru-Defense Eligible	■	■		

# EnLiten™ Flush-Glazed Internal Blinds



## AVAILABLE COLLECTIONS

- Smooth-Star.

## AVAILABLE DOOR STYLES



## AVAILABLE CONFIGURATIONS

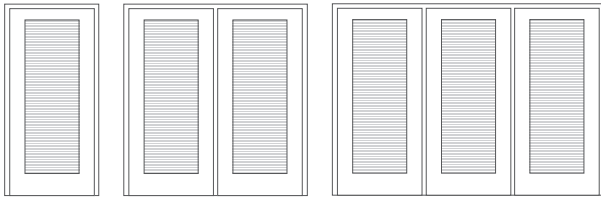

# Internal Blinds



## AVAILABLE COLLECTIONS

- Fiber-Classic® Mahogany
- Fiber-Classic® Oak
- Smooth-Star.
- Profiles™
- Traditions

## AVAILABLE DOOR STYLES

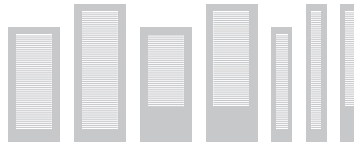

## AVAILABLE CONFIGURATIONS

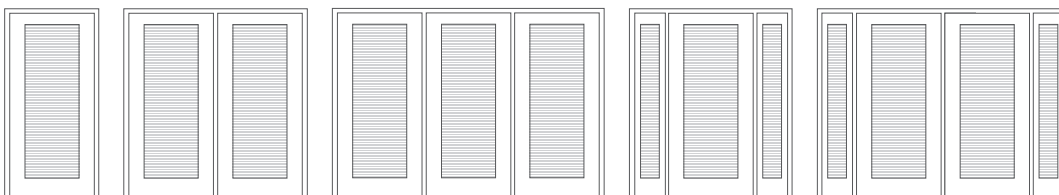

# EnLiten™ Flush-Glazed Low-E / Clear Glass with Divided Lites

## Colonial Style



### AVAILABLE COLLECTIONS

- Fiber-Classic. Oak
- Smooth-Star.

### AVAILABLE DOOR STYLES



### AVAILABLE CONFIGURATIONS

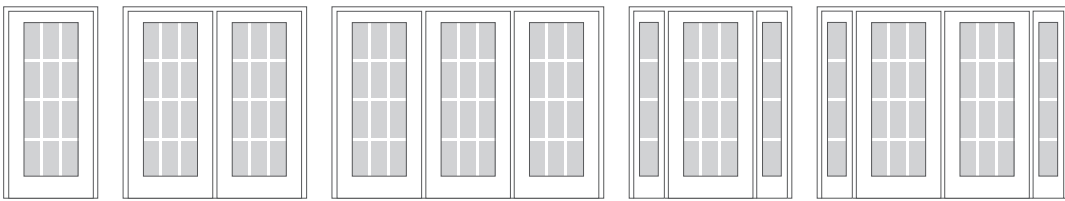

## Prairie Style



### AVAILABLE COLLECTIONS

- Fiber-Classic. Oak
- Smooth-Star.

### AVAILABLE DOOR STYLES



### AVAILABLE CONFIGURATIONS

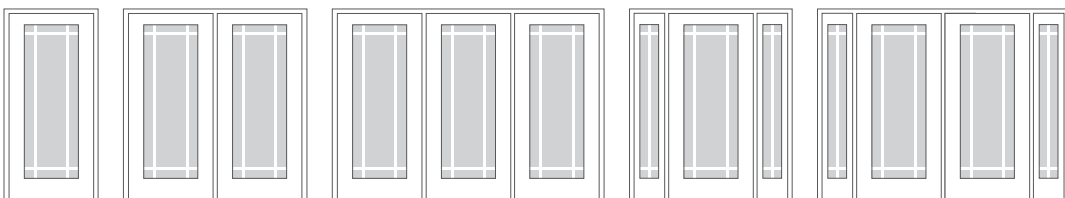

# EnLiten™ Flush-Glazed Low-E / Clear Glass 🔥



## AVAILABLE COLLECTIONS

- Fiber-Classic® Oak
- Smooth-Star®

## AVAILABLE DOOR STYLES

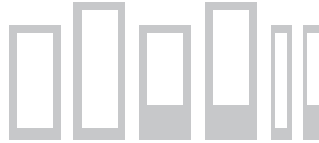

## AVAILABLE CONFIGURATIONS

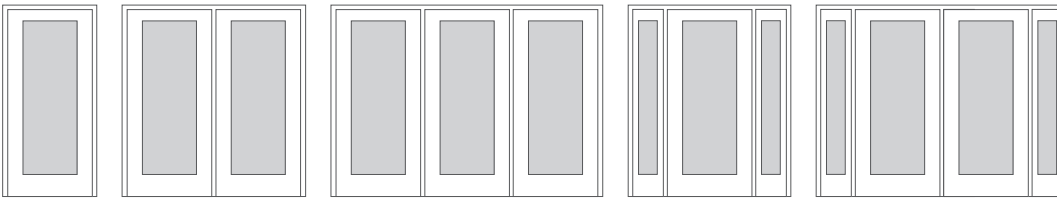

# Low-E / Clear Glass with Divided Lites

Colonial Style



## AVAILABLE COLLECTIONS

- Fiber-Classic® Mahogany
- Profiles™
- Fiber-Classic® Oak
- Traditions
- Smooth-Star®

## AVAILABLE DOOR STYLES



## AVAILABLE CONFIGURATIONS

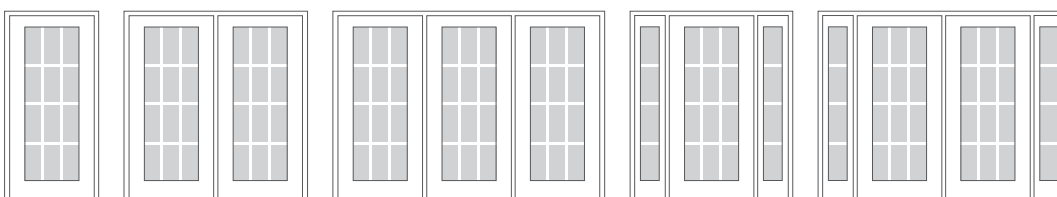

## Prairie Style



### AVAILABLE COLLECTIONS

- Fiber-Classic® Mahogany
- Fiber-Classic® Oak
- Smooth-Star®
- Profiles™
- Traditions

### AVAILABLE DOOR STYLES

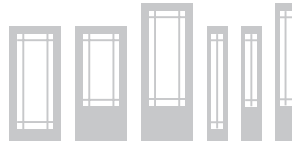

### AVAILABLE CONFIGURATIONS

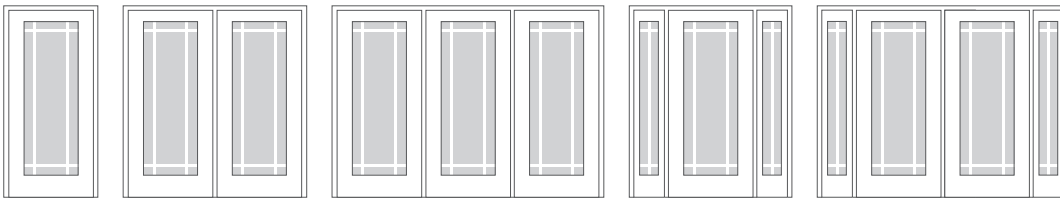

## Low-E / Clear Glass



### AVAILABLE COLLECTIONS

- Fiber-Classic® Mahogany
- Fiber-Classic® Oak
- Smooth-Star®
- Profiles™
- Traditions

### AVAILABLE DOOR STYLES



### AVAILABLE CONFIGURATIONS

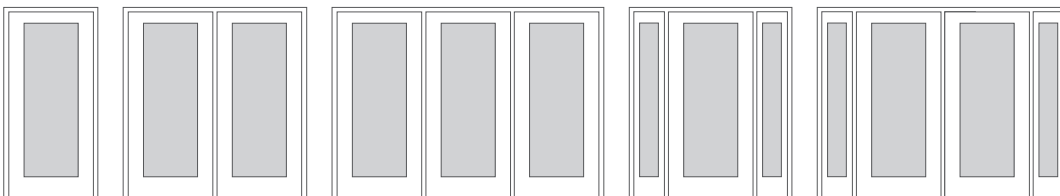

# Profiles™ Steel Doors



## Versatile, affordable options.

Coupling distinctive styling with affordability, Profiles steel doors offer versatile front entry and house-to-garage options. Designed to suit multiple home styles, these doors feature triple-shadowed panel embossments for greater detail.

Top: Profiles, Sedona Glass, Door - 996HD, Sidelite - 139SL  
Bottom: Profiles, Screen Vented Glass, Door - 1004HD



# Traditions Steel Doors



## Back to basics.

It's back to basics with Traditions. This line of steel doors combines attractive designs and value-based options to create a great, cost-conscious alternative for front entry and house-to-garage.





Top: Traditions Door – TS210  
Bottom: Traditions, Satin Etch Glass, Doors – TS289XE

# Profiles™ & Traditions Steel Doors

Find style at an affordable price point with options to match any home style and budget in Profiles and Traditions doors. Fire-rated options on 6'8" solid-panel doors make a perfect choice for house-to-garage.

- 1-¼" lock stiles.
- 12-½" lock blocks.
- No stile lines.
- Primed, ready-to-paint surface.

 **WBDR / HVHZ Options:** Look for this icon to find door styles that can be configured for WBDR or HVHZ.\*

 **20-Minute Fire-rated options** available on 6'8" solid-panel doors. See pages 240–243.



## Profiles Steel

Features 24-gauge steel, smooth surface and triple-shadowed panel embossments for greater definition.



## Traditions Steel

Features 25-gauge steel, standard embossed smooth surface. All 8'0" doors are 24-gauge steel with standard embossments.



	Profiles	Traditions
■ = Available		
• = Not Applicable		
P = Paint		
<b>Door Widths</b>		
2'0"	■	■
2'4"	■	■
2'6"	■	■
2'8"	■	■
2'10"	■	■
3'0"	■	■
3'6"	■	•
<b>Door Heights</b>		
6'6"	■	■
6'8"	■	■
7'0"	■	•
8'0"	•	■
<b>Glass Options</b>		
Decorative	16	16
Privacy & Textured	6	6
Internal Blinds	■	■
Screen Vented Lites	■	■
Simulated Divided Lites	■	■
Grilles Between Glass	■	■
Fixed Grilles	■	■
Low-E	■	■
Clear	■	■
<b>Frame Options</b>		
Advanta Lite Frame	■	■
Standard Lite Frame	■	■
Impact Lite Frame	■	■
<b>Additional Options</b>		
Finish	P	P

## RETROFIT HINGED PATIO DOORS

Replacing common slider sizes? Find hinged patio door options on pages 210–215.

5'0" Patio Opening = (2) 2'4" Doors

6'0" Patio Opening = (2) 2'10" Doors

\*Please verify that there is a Therma-Tru Impact-rated product approval for the configuration before buying.

\*\*Decorative glass designs are shown in Profiles only.

\*\*\*Brass coming not available for Impact.

Note: Finish colors may vary from an actual application due to fluctuations in finishing or printing. Glass privacy ratings may be more or less than indicated, based on glass design and size of glass. Glass designs may differ from depiction due to size and hand craftsmanship of glass. See your Therma-Tru seller or visit [thermatru.com](http://thermatru.com) for details on glass privacy ratings and designs, limited warranties and exclusions, ENERGY STAR qualified products and product approvals.

# Decorative & Specialty Glass Designs\*\*



Black Nickel    Brushed Nickel  
**Blackstone**®  
 Glass Privacy Rating: 7



Black Nickel    Brushed Nickel  
**Crystalline**™  
 Glass Privacy Rating: 7



Black Nickel    Brushed Nickel  
**Sedona**  
 Glass Privacy Rating: 7



Wrought Iron  
**Salinas**®  
 Glass Privacy Rating: 10



Black Nickel    Brushed Nickel  
**Maple Park**®  
 Glass Privacy Rating: 6



Black Nickel    Brushed Nickel  
**Saratoga**™  
 Glass Privacy Rating: 7



Black Nickel    Brushed Nickel  
**Texas Star**  
 Glass Privacy Rating: 5

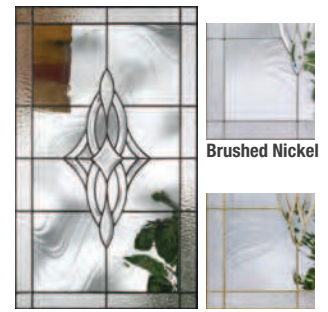

Black Nickel    Brass  
**Wellesley**™  
 Glass Privacy Rating: 6



Wrought Iron  
**Riserva**®  
 Glass Privacy Rating: 10



Black Nickel    Brass  
**Concorde**™  
 Glass Privacy Rating: 8



Black Nickel    Brushed Nickel  
**Kensington**™  
 Glass Privacy Rating: 8



Black Nickel    Brass\*\*\*  
**Pembroke**™  
 Glass Privacy Rating: 7

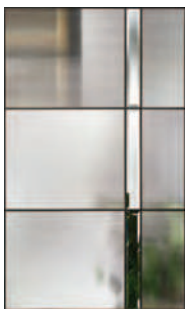

Black Nickel  
**Axis**®  
 Glass Privacy Rating: 7



Black Nickel    Brass  
**Calix**  
 Glass Privacy Rating: 1

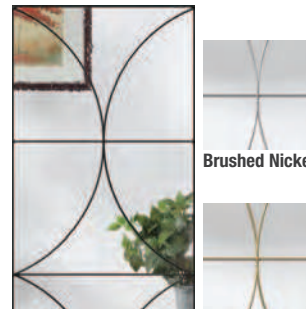

Black Nickel    Brass  
**Latitude**  
 Glass Privacy Rating: 2

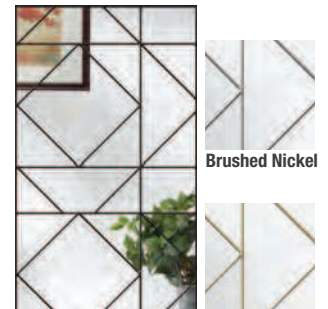

Black Nickel    Brass  
**Echelon**  
 Glass Privacy Rating: 1

Also Available:  
**Internal Blinds**  
**Screen Vented**

### Glass Privacy Rating Scale

1 2 3 4 5 6 7 8 9 10

Clear

Opaque

# Privacy & Textured Glass



**Reeded (XK)**  
Glass Privacy Rating: 7



**Satin Etch (XE)**  
Glass Privacy Rating: 10



**Chord (XC)**  
Glass Privacy Rating: 10



**Chinchilla (XJ)**  
Glass Privacy Rating: 10



**Rainglass (XR)**  
Glass Privacy Rating: 8



**Granite (XN)**  
Glass Privacy Rating: 10

### Glass Privacy Rating Scale



Clear

Opaque

Also Available:

**Divided Lites**  
**Clear Glass**



Note: See page 285 for important product details that may help with your purchase decision.

Bottom: Profiles, Salinas Glass, Door - 968HD, Sidelites - 971SLHD

# Full Lites

## BLACKSTONE. ◆ ◆



310

2'6" x 6'8" (7'0")  
2'8" x 6'8" (7'0")  
2'10" x 6'8" (7'0")  
3'0" x 6'8" (7'0")  
3'6" x 6'8" (7'0")

310SL

10" x 6'8"  
12" x 6'8" (7'0")  
14" x 6'8" (7'0")

## CRYSTALLINE. ◆ ◆



916

2'8" x 6'8" (7'0")  
2'10" x 6'8" (7'0")  
3'0" x 6'8" (7'0")  
3'6" x 6'8" (7'0")

916SL

10" x 6'8"  
12" x 6'8" (7'0")  
14" x 6'8" (7'0")

## SEDONA. ◆ ◆



139

2'6" x 6'8" (7'0")  
2'8" x 6'8" (7'0")  
2'10" x 6'8" (7'0")  
3'0" x 6'8" (7'0")  
3'6" x 6'8" (7'0")

139SL

10" x 6'8"  
12" x 6'8" (7'0")  
14" x 6'8" (7'0")

## SALINAS. ✕



369

2'6" x 6'8" (7'0")  
2'8" x 6'8" (7'0")  
2'10" x 6'8" (7'0")  
3'0" x 6'8" (7'0")  
3'6" x 6'8" (7'0")

369SL

10" x 6'8"  
12" x 6'8" (7'0")  
14" x 6'8" (7'0")

## MAPLE PARK. ◆ ◆



1006

2'8" x 6'8" (7'0")  
2'10" x 6'8" (7'0")  
3'0" x 6'8" (7'0")  
3'6" x 6'8" (7'0")

1006SL

10" x 6'8"  
12" x 6'8" (7'0")  
14" x 6'8" (7'0")

## SARATOGA. ◆ ◆



610

2'6" x 6'8" (7'0")  
2'8" x 6'8" (7'0")  
2'10" x 6'8" (7'0")  
3'0" x 6'8" (7'0")  
3'6" x 6'8" (7'0")

610SL

10" x 6'8"  
12" x 6'8" (7'0")  
14" x 6'8" (7'0")

## TEXAS STAR. ◆ ◆



1029

2'8" x 6'8" (7'0")  
2'10" x 6'8" (7'0")  
3'0" x 6'8" (7'0")  
3'6" x 6'8" (7'0")

1029SL

10" x 6'8"  
12" x 6'8" (7'0")  
14" x 6'8" (7'0")

## WELLESLEY. ◆ ◆ ◆



620

2'6" x 6'8" (7'0")  
2'8" x 6'8" (7'0")  
2'10" x 6'8" (7'0")  
3'0" x 6'8" (7'0")  
3'6" x 6'8" (7'0")

620SL

10" x 6'8"  
12" x 6'8" (7'0")  
14" x 6'8" (7'0")

## RISERVA. ✕



571

2'6" x 6'8" (7'0")  
2'8" x 6'8" (7'0")  
2'10" x 6'8" (7'0")  
3'0" x 6'8" (7'0")  
3'6" x 6'8" (7'0")

TS572SL

10" x 6'8"  
12" x 6'8" (7'0")  
14" x 6'8" (7'0")

### Key

- ◆ Black Nickel Caming (1D)
- ◆ Flat Lite Frame
- ◆ WBDR / HVHZ Options
- ◆ Brushed Nickel Caming (1C)
- ◆ Scrolled & Flat Advanta Lite Frame
- ◆ Not available for 2'4" and 2'6" doors or 10" sidelites.
- ◆ Brass Caming (1A)
- ◆ Wrought Iron (1W)
- ▲ 6'6" Height Available

**CONCORDE™** ◆ ◆ ◆



**1028**  
 2'6" x 6'8" (7'0")  
 2'8" x 6'8" (7'0")  
 2'10" x 6'8" (7'0")  
 3'0" x 6'8" (7'0")  
 3'6" x 6'8" (7'0")



**416SL**  
 10" x 6'8"  
 12" x 6'8" (7'0")  
 14" x 6'8" (7'0")

**KENSINGTON™** ◆ ◆ ◆



**626**  
 2'8" x 6'8" (7'0")  
 2'10" x 6'8" (7'0")  
 3'0" x 6'8" (7'0")  
 3'6" x 6'8" (7'0")



**626SL**  
 10" x 6'8"  
 12" x 6'8" (7'0")  
 14" x 6'8" (7'0")

**PEMBRIDGE™** ◆ ◆ ◆

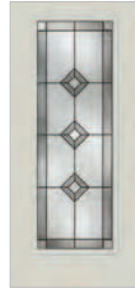

**6500HD**  
 2'4" x 6'8"  
 2'6" x 6'8" (7'0")  
 2'8" x 6'8" (7'0")  
 2'10" x 6'8" (7'0")  
 3'0" x 6'8" (7'0")  
 3'6" x 6'8" (7'0")



**6500SL**  
 10" x 6'8"  
 12" x 6'8" (7'0")  
 14" x 6'8" (7'0")

**AXIS®** ◆



**1651HD**  
 2'4" x 6'8"  
 2'6" x 6'8" (7'0")  
 2'8" x 6'8" (7'0")  
 2'10" x 6'8" (7'0")  
 3'0" x 6'8" (7'0")  
 3'6" x 6'8" (7'0")



**1651SL**  
 10" x 6'8"  
 12" x 6'8" (7'0")  
 14" x 6'8" (7'0")

**CALIX** ◆ ◆ ◆

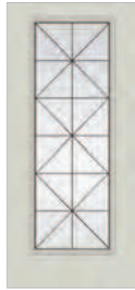

**2389HD**  
 2'8" x 6'8" (7'0")  
 2'10" x 6'8" (7'0")  
 3'0" x 6'8" (7'0")  
 3'6" x 6'8" (7'0")

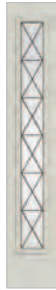

**2389SL**  
 10" x 6'8"  
 12" x 6'8" (7'0")  
 14" x 6'8" (7'0")

**LATITUDE** ◆ ◆ ◆



**2382HD**  
 2'8" x 6'8" (7'0")  
 2'10" x 6'8" (7'0")  
 3'0" x 6'8" (7'0")  
 3'6" x 6'8" (7'0")



**2382SL**  
 10" x 6'8"  
 12" x 6'8" (7'0")  
 14" x 6'8" (7'0")

**ECHELON** ◆ ◆ ◆

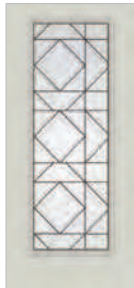

**2385HD**  
 2'8" x 6'8" (7'0")  
 2'10" x 6'8" (7'0")  
 3'0" x 6'8" (7'0")  
 3'6" x 6'8" (7'0")



**2385SL**  
 10" x 6'8"  
 12" x 6'8" (7'0")  
 14" x 6'8" (7'0")

**PRIVACY & TEXTURED GLASS WITH DIVIDED LITES**



**128**  
 2'8" x 6'8" (7'0")  
 2'10" x 6'8" (7'0")  
 3'0" x 6'8" (7'0")  
 3'6" x 6'8" (7'0")



**108**  
 2'8" x 6'8" (7'0")  
 2'10" x 6'8" (7'0")  
 3'0" x 6'8" (7'0")  
 3'6" x 6'8" (7'0")



**6184\_SL\***  
 10" x 6'8"  
 12" x 6'8" (7'0")  
 14" x 6'8" (7'0")



**6185\_SL\***  
 10" x 6'8"  
 12" x 6'8" (7'0")  
 14" x 6'8" (7'0")



**6186\_SL\***  
 10" x 6'8"  
 12" x 6'8" (7'0")  
 14" x 6'8" (7'0")



**632\_SL**  
 10" x 6'8"  
 12" x 6'8" (7'0")  
 14" x 6'8" (7'0")

**Privacy & Textured Glass Options**

Add the code to the blank in the style number for the desired door and glass combination. For details on glass options, see page 220.

**XK = Reeded**    **XC = Chord**    **XR = Rainglass**  
**XE = Satin Etch**    **XJ = Chinchilla**    **XN = Granite**

\*Not available with Reeded (XK) glass.

\*\*Available with Impact-rated lite frame only.

Note: See page 285 for important product details that may help with your purchase decision.

### PRIVACY & TEXTURED GLASS



**118**  

 2'8" x 6'8" (7'0")  
 2'10" x 6'8" (7'0")  
 3'0" x 6'8" (7'0")  
 3'6" x 6'8" (7'0")



**100\_SL**  

 10" x 6'8"  
 12" x 6'8" (7'0")  
 14" x 6'8" (7'0")

### INTERNAL BLINDS



**130**  

 2'4" x 6'8"  
 2'6" x 6'8" (7'0")  
 2'8" x 6'8" (7'0")  
 2'10" x 6'8" (7'0")  
 3'0" x 6'8" (7'0")  
 3'6" x 6'8" (7'0")



**130SL**  

 10" x 6'8"  
 12" x 6'8" (7'0")  
 14" x 6'8" (7'0")

### CLEAR GLASS WITH DIVIDED LITES



**1201**  

 2'6" x 6'8" (7'0")  
 2'8" x 6'8" (7'0")  
 2'10" x 6'8" (7'0")  
 3'0" x 6'8" (7'0")  
 3'6" x 6'8" (7'0")



**1202**  

 2'6" x 6'8" (7'0")  
 2'8" x 6'8" (7'0")  
 2'10" x 6'8" (7'0")  
 3'0" x 6'8" (7'0")  
 3'6" x 6'8" (7'0")



**1203**  

 2'6" x 6'8" (7'0")  
 2'8" x 6'8" (7'0")  
 2'10" x 6'8" (7'0")  
 3'0" x 6'8" (7'0")  
 3'6" x 6'8" (7'0")



**128**  

 2'6" x 6'8" (7'0")  
 2'8" x 6'8" (7'0")  
 2'10" x 6'8" (7'0")  
 3'0" x 6'8" (7'0")  
 3'6" x 6'8" (7'0")



**1200**  

 2'6" x 6'8" (7'0")  
 2'8" x 6'8" (7'0")  
 2'10" x 6'8" (7'0")  
 3'0" x 6'8" (7'0")  
 3'6" x 6'8" (7'0")



**108**  

 2'6" x 6'8" (7'0")  
 2'8" x 6'8" (7'0")  
 2'10" x 6'8" (7'0")  
 3'0" x 6'8" (7'0")  
 3'6" x 6'8" (7'0")



**1201SL**  

 10" x 6'8"  
 12" x 6'8" (7'0")  
 14" x 6'8" (7'0")



**1202SL**  

 10" x 6'8"  
 12" x 6'8" (7'0")  
 14" x 6'8" (7'0")



**1200SL**  

 10" x 6'8"  
 12" x 6'8" (7'0")  
 14" x 6'8" (7'0")



**632SL**  

 10" x 6'8"  
 12" x 6'8" (7'0")  
 14" x 6'8" (7'0")



**6184SL**  

 10" x 6'8"  
 12" x 6'8" (7'0")  
 14" x 6'8" (7'0")

### CLEAR GLASS



**6185SL**  

 10" x 6'8"  
 12" x 6'8" (7'0")  
 14" x 6'8" (7'0")



**6186SL**  

 10" x 6'8"  
 12" x 6'8" (7'0")  
 14" x 6'8" (7'0")



**198**  

 2'6" x 6'8" (7'0")  
 2'8" x 6'8" (7'0")  
 2'10" x 6'8" (7'0")  
 3'0" x 6'8" (7'0")  
 3'6" x 6'8" (7'0")



**198SL**  

 10" x 6'8"  
 12" x 6'8" (7'0")  
 14" x 6'8" (7'0")



**118**  

 2'0" x 6'8"\*\*\*  
 2'4" x 6'8"\*\*\*  
 2'6" x 6'8" (7'0")\*\*  
 2'8" x 6'8" (7'0")  
 2'10" x 6'8" (7'0")  
 3'0" x 6'8" (7'0")  
 3'6" x 6'8" (7'0")



**100SL**  

 10" x 6'8"  
 12" x 6'8" (7'0")  
 14" x 6'8" (7'0")

### Key

- Low-E Glass (LE)
- Turtle Glass
- Black Nickel Caming (1D)
- Brushed Nickel Caming (1C)
- Brass Caming (1A)
- Simulated Divided Lites (SDL)
- Flat or Contour White Grilles Between Glass (GBGF / GBGC)
- Flat Almond Grilles Between Glass (GBGF)
- Flat Bronze Grilles Between Glass (GBGF)
- Flat or Contour Black Grilles Between Glass (GBGF / GBGC)
- Fixed Grilles (FXG)
- Flat Lite Frame
- Scrolled & Flat Advanta Lite Frame  
Not available for 2'4" and 2'6" doors or 10" sidelites.
- WBDP / HVHZ Options
- 6'6" Height Available

# 3/4 Lites

## BLACKSTONE. ♦ ♦



**1037HD**  
 2'8" x 6'8"  
 2'10" x 6'8"  
 3'0" x 6'8"

**1037SLHD**  
 12" x 6'8"  
 14" x 6'8"

## CRYSTALLINE™ ♦ ♦



**1042HD**  
 2'8" x 6'8"  
 2'10" x 6'8"  
 3'0" x 6'8"

**956SLHD**  
 12" x 6'8"  
 14" x 6'8"

## SEDONA ♦ ♦



**965HD**  
 2'8" x 6'8"  
 2'10" x 6'8"  
 3'0" x 6'8"

**965SLHD**  
 12" x 6'8"  
 14" x 6'8"

## SALINAS. X



**968HD**  
 2'8" x 6'8"  
 2'10" x 6'8"  
 3'0" x 6'8"

**971SLHD**  
 12" x 6'8"  
 14" x 6'8"

## MAPLE PARK. ♦ ♦



**1009HD**  
 2'8" x 6'8"  
 2'10" x 6'8"  
 3'0" x 6'8"

**1009SLHD**  
 12" x 6'8"  
 14" x 6'8"

## SARATOGA™ ♦ ♦



**1039HD**  
 2'8" x 6'8"  
 2'10" x 6'8"  
 3'0" x 6'8"

**1039SLHD**  
 12" x 6'8"  
 14" x 6'8"

## TEXAS STAR ♦ ♦



**1040HD**  
 2'8" x 6'8"  
 2'10" x 6'8"  
 3'0" x 6'8"

**1040SLHD**  
 12" x 6'8"  
 14" x 6'8"

## WELLESLEY™ ♦ ♦ ♦



**1041HD**  
 2'8" x 6'8"  
 2'10" x 6'8"  
 3'0" x 6'8"

**1041SLHD**  
 12" x 6'8"  
 14" x 6'8"

## RISERVA. X



**544HD**  
 2'8" x 6'8"  
 2'10" x 6'8"  
 3'0" x 6'8"

**546SLHD**  
 12" x 6'8"  
 14" x 6'8"

## CONCORDE™ ♦ ♦ ♦

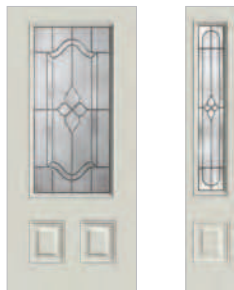

**967HD**  
 2'8" x 6'8"  
 2'10" x 6'8"  
 3'0" x 6'8"

**967SLHD**  
 12" x 6'8"  
 14" x 6'8"

## KENSINGTON™ ♦ ♦



**03142HD**  
 2'8" x 6'8"  
 2'10" x 6'8"  
 3'0" x 6'8"

**966SLHD**  
 12" x 6'8"  
 14" x 6'8"

## PEMBRIDGE™ ♦ ♦ ♦



**6582HD**  
 2'8" x 6'8"  
 2'10" x 6'8"  
 3'0" x 6'8"

**6580SLHD**  
 12" x 6'8"  
 14" x 6'8"

### Privacy & Textured Glass Options

Add the code to the blank in the style number for the desired door and glass combination. For details on glass options, see page 220.

XK = Reeded

XC = Chord

XR = Rainglass

XE = Satin Etch

XJ = Chinchilla

XN = Granite



**AXIS** ◆



**1644HD**  
 ◆ 6  
 2'8" x 6'8"  
 2'10" x 6'8"  
 3'0" x 6'8"

**1644SLHD**  
 ◆ 6  
 12" x 6'8"  
 14" x 6'8"

**CALIX** ◆ ■◆

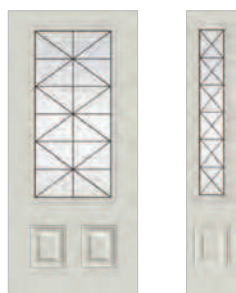

**391HD**  
 ◆ 6  
 2'8" x 6'8"  
 2'10" x 6'8"  
 3'0" x 6'8"

**391SLHD**  
 ◆ 6  
 12" x 6'8"  
 14" x 6'8"

**LATITUDE** ◆ ■◆



**469HD**  
 ◆ 6  
 2'8" x 6'8"  
 2'10" x 6'8"  
 3'0" x 6'8"

**469SLHD**  
 ◆ 6  
 12" x 6'8"  
 14" x 6'8"

**PRIVACY & TEXTURED GLASS**



**961HD\_**  
 ■ ◆  
 2'8" x 6'8"  
 2'10" x 6'8"  
 3'0" x 6'8"

**959HD\_**  
 ◆ 6  
 2'8" x 6'8"  
 2'10" x 6'8"  
 3'0" x 6'8"

**6720HD\_SL**  
 ■ ◆  
 12" x 6'8"  
 14" x 6'8"

**959HD\_SL**  
 ◆ 6  
 12" x 6'8"  
 14" x 6'8"

**INTERNAL BLINDS**



**5425**  
 \* ◆ 6  
 2'8" x 6'8"  
 2'10" x 6'8"  
 3'0" x 6'8"

**5425SL**  
 \* ◆ 6  
 12" x 6'8"  
 14" x 6'8"

**CLEAR GLASS WITH DIVIDED LITES**



**2109HD**  
 \* ◆ ◆ ◆ ◆ ◆  
 2'8" x 6'8"  
 2'10" x 6'8"  
 3'0" x 6'8"

**2110HD**  
 \* ◆ ◆ ◆ ◆ ◆ 6  
 2'8" x 6'8"  
 2'10" x 6'8"  
 3'0" x 6'8"

**CLEAR GLASS**



**2111HD**  
 \* ◆ ◆ ◆ ◆ ◆ ◆  
 2'8" x 6'8"  
 2'10" x 6'8"  
 3'0" x 6'8"

**961HD**  
 \* ■ ◆ ◆ ◆ ◆ ◆ 6  
 2'8" x 6'8"  
 2'10" x 6'8"  
 3'0" x 6'8"

**1089SLHD**  
 \* ◆ ◆ ◆ ◆ ◆ ◆  
 12" x 6'8"  
 14" x 6'8"

**4572SLHD**  
 \* ◆ ◆ ◆ ◆ ◆ ◆ 6  
 12" x 6'8"  
 14" x 6'8"

**6720SLHD**  
 \* ◆ ◆ ◆ ◆ ◆ ◆ 6  
 12" x 6'8"  
 14" x 6'8"

**1403HD**  
 \* ◆ ◆ ◆ ◆ ◆ ◆  
 2'8" x 6'8"  
 2'10" x 6'8"  
 3'0" x 6'8"

**1400SLHD**  
 \* ◆ ◆ ◆ ◆ ◆ ◆  
 12" x 6'8"  
 14" x 6'8"



**959HD**  
 \* ◆ 6  
 2'8" x 6'8"  
 2'10" x 6'8"  
 3'0" x 6'8"

**959SLHD**  
 \* ◆ 6  
 12" x 6'8"  
 14" x 6'8"

**Key**

- ★ Low-E Glass (LE)
- ◆ Black Nickel Caming (1D)
- Brushed Nickel Caming (1C)
- ◆ Brass Caming (1A)
- ✕ Wrought Iron (1W)
- Simulated Divided Lites (SDL)
- ◆ Flat or Contour White Grilles Between Glass (GBGF / GBGC)
- ◆ Flat Almond Grilles Between Glass (GBGF)
- ◆ Flat Bronze Grilles Between Glass (GBGF)
- ◆ Flat or Contour Black Grilles Between Glass (GBGF / GBGC)
- ◆ Scrolled Advanta Lite Frame Not available for 2'4" and 2'6" doors or 10" sidelites.
- ◆ Scrolled & Flat Advanta Lite Frame Not available for 2'4" and 2'6" doors or 10" sidelites.
- 6 WBDR / HVHZ Options

# Oval Lites

## BLACKSTONE



1025HD

2'8" x 6'8"  
2'10" x 6'8"  
3'0" x 6'8"

## WELLESLEY



1022HD

2'8" x 6'8"  
2'10" x 6'8"  
3'0" x 6'8"

## CONCORDE



1024HD

2'8" x 6'8"  
2'10" x 6'8"  
3'0" x 6'8"

## KENSINGTON



630HD

2'8" x 6'8"  
2'10" x 6'8"  
3'0" x 6'8"

## PEMBRIDGE



6578HD

2'8" x 6'8"  
2'10" x 6'8"  
3'0" x 6'8"

## CLEAR GLASS



1020HD

2'8" x 6'8"  
2'10" x 6'8"  
3'0" x 6'8"

# 1/2 Lites

## BLACKSTONE



309HD

2'6" x 6'8" (7'0")  
2'8" x 6'8" (7'0")  
2'10" x 6'8" (7'0")  
3'0" x 6'8" (7'0")



1001HD

2'8" x 6'8"  
2'10" x 6'8"  
3'0" x 6'8"



1117HD

2'8" x 6'8"  
2'10" x 6'8"  
3'0" x 6'8"

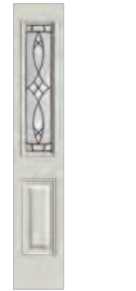

311SLHD

12" x 6'8" (7'0")  
14" x 6'8" (7'0")

## SEDONA



211HD

2'6" x 6'8" (7'0")  
2'8" x 6'8" (7'0")  
2'10" x 6'8" (7'0")  
3'0" x 6'8" (7'0")

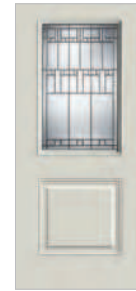

996HD

2'8" x 6'8"  
2'10" x 6'8"  
3'0" x 6'8"



1114HD

2'8" x 6'8"  
2'10" x 6'8"  
3'0" x 6'8"



294SLHD

12" x 6'8" (7'0")  
14" x 6'8" (7'0")

## SALINAS



374HD

2'6" x 6'8" (7'0")  
2'8" x 6'8" (7'0")  
2'10" x 6'8" (7'0")  
3'0" x 6'8" (7'0")



1002HD

2'8" x 6'8"  
2'10" x 6'8"  
3'0" x 6'8"



1115HD

2'8" x 6'8"  
2'10" x 6'8"  
3'0" x 6'8"



371SLHD

12" x 6'8" (7'0")  
14" x 6'8" (7'0")

## MAPLE PARK



1007HD

2'8" x 6'8" (7'0")  
2'10" x 6'8" (7'0")  
3'0" x 6'8" (7'0")



1011HD

2'8" x 6'8"  
2'10" x 6'8"  
3'0" x 6'8"



1116HD

2'8" x 6'8"  
2'10" x 6'8"  
3'0" x 6'8"

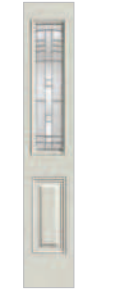

1007SLHD

12" x 6'8" (7'0")  
14" x 6'8" (7'0")

**SARATOGA™** ◆ ◆



**613HD**  
 ◆ ◆  
 2'6" x 6'8" (7'0")  
 2'8" x 6'8" (7'0")  
 2'10" x 6'8" (7'0")  
 3'0" x 6'8" (7'0")

**988HD**  
 ◆ ◆  
 2'8" x 6'8"  
 2'10" x 6'8"  
 3'0" x 6'8"

**1112HD**  
 ◆ ◆  
 2'8" x 6'8"  
 2'10" x 6'8"  
 3'0" x 6'8"

**615SLHD**  
 ◆ ◆  
 12" x 6'8" (7'0")  
 14" x 6'8" (7'0")

**TEXAS STAR** ◆ ◆



**1032HD**  
 ◆ ◆  
 2'8" x 6'8" (7'0")  
 2'10" x 6'8" (7'0")  
 3'0" x 6'8" (7'0")

**1035HD**  
 ◆ ◆  
 2'8" x 6'8"  
 2'10" x 6'8"  
 3'0" x 6'8"

**1111HD**  
 ◆ ◆  
 2'8" x 6'8"  
 2'10" x 6'8"  
 3'0" x 6'8"

**WELLESLEY™** ◆ ◆ ◆



**623HD**  
 ◆ ◆  
 2'6" x 6'8" (7'0")  
 2'8" x 6'8" (7'0")  
 2'10" x 6'8" (7'0")  
 3'0" x 6'8" (7'0")

**989HD**  
 ◆ ◆  
 2'8" x 6'8"  
 2'10" x 6'8"  
 3'0" x 6'8"

**1120HD**  
 ◆ ◆  
 2'8" x 6'8"  
 2'10" x 6'8"  
 3'0" x 6'8"

**625SLHD**  
 ◆ ◆  
 12" x 6'8" (7'0")  
 14" x 6'8" (7'0")

**RISERVA®** X



**582HD**  
 ◆ ◆  
 2'6" x 6'8" (7'0")  
 2'8" x 6'8" (7'0")  
 2'10" x 6'8" (7'0")  
 3'0" x 6'8" (7'0")

**576HD**  
 ◆ ◆  
 2'8" x 6'8"  
 2'10" x 6'8"  
 3'0" x 6'8"

**578HD**  
 ◆ ◆  
 2'8" x 6'8"  
 2'10" x 6'8"  
 3'0" x 6'8"

**584SLHD**  
 ◆ ◆  
 12" x 6'8" (7'0")  
 14" x 6'8" (7'0")

**CONCORDE™** ◆ ◆ ◆



**426HD**  
 ◆ ◆  
 2'6" x 6'8" (7'0")  
 2'8" x 6'8" (7'0")  
 2'10" x 6'8" (7'0")  
 3'0" x 6'8" (7'0")

**999HD**  
 ◆ ◆  
 2'8" x 6'8"  
 2'10" x 6'8"  
 3'0" x 6'8"

**1118HD**  
 ◆ ◆  
 2'8" x 6'8"  
 2'10" x 6'8"  
 3'0" x 6'8"

**430SLHD**  
 ◆ ◆  
 12" x 6'8" (7'0")  
 14" x 6'8" (7'0")

**KENSINGTON™** ◆ ◆

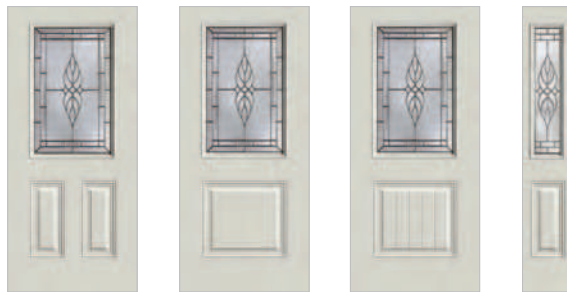

**627HD**  
 ◆ ◆  
 2'8" x 6'8" (7'0")  
 2'10" x 6'8" (7'0")  
 3'0" x 6'8" (7'0")

**631HD**  
 ◆ ◆  
 2'8" x 6'8"  
 2'10" x 6'8"  
 3'0" x 6'8"

**1113HD**  
 ◆ ◆  
 2'8" x 6'8"  
 2'10" x 6'8"  
 3'0" x 6'8"

**628SLHD**  
 ◆ ◆  
 12" x 6'8" (7'0")  
 14" x 6'8" (7'0")

**Key**

- ★ Low-E Glass (LE)
- ◆ Black Nickel Caming (1D)
- ◆ ◆ Brushed Nickel Caming (1C)
- ◆ ◆ Brass Caming (1A)
- ✕ Wrought Iron (1W)
- ◆ Scrolled Advanta Lite Frame  
 Not available for 2'4" and 2'6" doors or 10" sidelites.
- ◆ Scrolled & Flat Advanta Lite Frame  
 Not available for 2'4" and 2'6" doors or 10" sidelites.
- ◆ WBDL / HVHZ Options

**PEMBRIDGE™** ◆ ◆ ◆



**6560HD**  
 2'6" x 6'8" (7'0")  
 2'8" x 6'8" (7'0")  
 2'10" x 6'8" (7'0")  
 3'0" x 6'8" (7'0")

**6565HD**  
 2'8" x 6'8"  
 2'10" x 6'8"  
 3'0" x 6'8"

**6568HD**  
 2'8" x 6'8"  
 2'10" x 6'8"  
 3'0" x 6'8"

**6565SLHD**  
 12" x 6'8" (7'0")  
 14" x 6'8" (7'0")

**AXIS** ◆



**1660HD**  
 2'6" x 6'8" (7'0")  
 2'8" x 6'8" (7'0")  
 2'10" x 6'8" (7'0")  
 3'0" x 6'8" (7'0")

**1657HD**  
 2'8" x 6'8"  
 2'10" x 6'8"  
 3'0" x 6'8"

**1659HD**  
 2'8" x 6'8"  
 2'10" x 6'8"  
 3'0" x 6'8"

**1657SLHD**  
 12" x 6'8" (7'0")  
 14" x 6'8" (7'0")

**CALIX** ◆ ◆ ◆

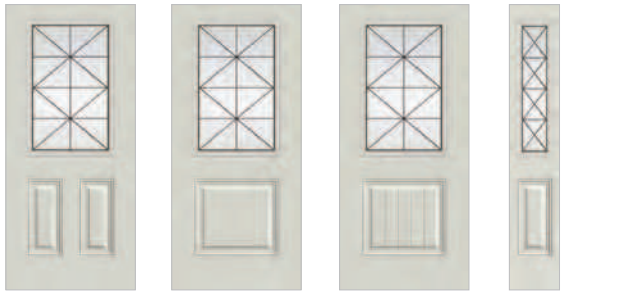

**835HD**  
 2'8" x 6'8" (7'0")  
 2'10" x 6'8" (7'0")  
 3'0" x 6'8" (7'0")

**395HD**  
 2'8" x 6'8"  
 2'10" x 6'8"  
 3'0" x 6'8"

**397HD**  
 2'8" x 6'8"  
 2'10" x 6'8"  
 3'0" x 6'8"

**395SLHD**  
 12" x 6'8" (7'0")  
 14" x 6'8" (7'0")

**PRIVACY & TEXTURED GLASS WITH DIVIDED LITES**



**262HD**  
 2'8" x 6'8" (7'0")  
 2'10" x 6'8" (7'0")  
 3'0" x 6'8" (7'0")

**982HD**  
 2'8" x 6'8"  
 2'10" x 6'8"  
 3'0" x 6'8"

**1123HD**  
 2'8" x 6'8"  
 2'10" x 6'8"  
 3'0" x 6'8"

**263SLHD**  
 12" x 6'8" (7'0")  
 14" x 6'8" (7'0")

**PRIVACY & TEXTURED GLASS**



**206HD**  
 2'8" x 6'8" (7'0")  
 2'10" x 6'8" (7'0")  
 3'0" x 6'8" (7'0")

**980HD**  
 2'8" x 6'8"  
 2'10" x 6'8"  
 3'0" x 6'8"

**1101\_HD**  
 2'8" x 6'8"  
 2'10" x 6'8"  
 3'0" x 6'8"

**104**  
 2'8" x 6'8" (7'0")  
 2'10" x 6'8" (7'0")  
 3'0" x 6'8" (7'0")

**210SLHD**  
 12" x 6'8" (7'0")  
 14" x 6'8" (7'0")

**INTERNAL BLINDS**



**132HD**  
 2'6" x 6'8" (7'0")  
 2'8" x 6'8" (7'0")  
 2'10" x 6'8" (7'0")  
 3'0" x 6'8" (7'0")

**984HD**  
 2'8" x 6'8"  
 2'10" x 6'8"  
 3'0" x 6'8"

**Privacy & Textured Glass Options**

Add the code to the blank in the style number for the desired door and glass combination. For details on glass options, see page 220.

XK = Reeded XC = Chord XR = Rainglass  
 XE = Satin Etch XJ = Chinchilla XN = Granite

\*Features a gliding operation and sash locking system.

Note: See page 285 for important product details that may help with your purchase decision.

### SCREEN VENTED LITES\*



**1121HD**  
 \* 6  
 2'8" x 6'8"  
 2'10" x 6'8"  
 3'0" x 6'8"



**131**  
 \* 6 E  
 2'6" x 6'8" (7'0")  
 2'8" x 6'8" (7'0")  
 2'10" x 6'8" (7'0")  
 3'0" x 6'8" (7'0")



**132SLHD**  
 \* 6  
 12" x 6'8" (7'0")  
 14" x 6'8" (7'0")



**243HD**  
 2'8" x 6'8" (7'0")  
 2'10" x 6'8" (7'0")  
 3'0" x 6'8" (7'0")



**1004HD**  
 2'8" x 6'8"  
 2'10" x 6'8"  
 3'0" x 6'8"



**1102HD**  
 2'8" x 6'8"  
 2'10" x 6'8"  
 3'0" x 6'8"

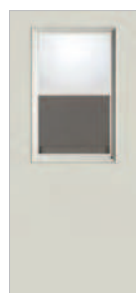

**137**  
 E  
 2'8" x 6'8" (7'0")  
 2'10" x 6'8" (7'0")  
 3'0" x 6'8" (7'0")

### CLEAR GLASS WITH DIVIDED LITES



**262HD**  
 \* 6  
 2'6" x 6'8" (7'0")  
 2'8" x 6'8" (7'0")  
 2'10" x 6'8" (7'0")  
 3'0" x 6'8" (7'0")



**982HD**  
 \* 6  
 2'8" x 6'8"  
 2'10" x 6'8"  
 3'0" x 6'8"



**1123HD**  
 \* 6  
 2'8" x 6'8"  
 2'10" x 6'8"  
 3'0" x 6'8"



**115HD**  
 \* E  
 2'6" x 6'8" (7'0")  
 2'8" x 6'8" (7'0")  
 2'10" x 6'8" (7'0")  
 3'0" x 6'8" (7'0")



**263SLHD**  
 \* 6  
 12" x 6'8" (7'0")  
 14" x 6'8" (7'0")



**1408HD**  
 \* 6  
 2'6" x 6'8" (7'0")  
 2'8" x 6'8" (7'0")  
 2'10" x 6'8" (7'0")  
 3'0" x 6'8" (7'0")



**1405HD**  
 \* 6  
 2'8" x 6'8"  
 2'10" x 6'8"  
 3'0" x 6'8"



**1406HD**  
 \* 6  
 2'8" x 6'8"  
 2'10" x 6'8"  
 3'0" x 6'8"

### CLEAR GLASS



**1405SLHD**  
 \* 6  
 12" x 6'8" (7'0")  
 14" x 6'8" (7'0")



**206HD**  
 \* 6  
 2'6" x 6'8" (7'0")  
 2'8" x 6'8" (7'0")  
 2'10" x 6'8" (7'0")  
 3'0" x 6'8" (7'0")



**980HD**  
 \* 6  
 2'8" x 6'8"  
 2'10" x 6'8"  
 3'0" x 6'8"



**1101HD**  
 \* 6  
 2'8" x 6'8"  
 2'10" x 6'8"  
 3'0" x 6'8"



**104**  
 \* 6 E  
 2'6" x 6'8" (7'0")  
 2'8" x 6'8" (7'0")  
 2'10" x 6'8" (7'0")  
 3'0" x 6'8" (7'0")



**105**  
 \* E  
 2'6" x 6'8" (7'0")  
 2'8" x 6'8" (7'0")  
 2'10" x 6'8" (7'0")  
 3'0" x 6'8" (7'0")



**210SLHD**  
 \* 6  
 12" x 6'8" (7'0")  
 14" x 6'8" (7'0")

### Key

- Low-E Glass (LE)
- Black Nickel Caming (1D)
- Brushed Nickel Caming (1C)
- Brass Caming (1A)
- Simulated Divided Lites (SDL)
- Flat or Contour White Grilles Between Glass (GBGF / GBGC)
- Flat Almond Grilles Between Glass (GBGF)
- Flat Bronze Grilles Between Glass (GBGF)
- Flat or Contour Black Grilles Between Glass (GBGF / GBGC)
- Fixed Grilles (FXG)
- Scrolled & Flat Advanta Lite Frame  
Not available for 2'4" and 2'6" doors or 10" sidelites.
- Scrolled Advanta Lite Frame  
Not available for 2'4" and 2'6" doors or 10" sidelites.
- WBDR / HVHZ Options
- Elevated 10" Bottom Rail Options

# Twin 1/2 Lites

## BLACKSTONE®



311HD

2'6" x 6'8" (7'0")  
2'8" x 6'8" (7'0")  
2'10" x 6'8" (7'0")  
3'0" x 6'8" (7'0")

## SEDONA



294HD

2'6" x 6'8" (7'0")  
2'8" x 6'8" (7'0")  
2'10" x 6'8" (7'0")  
3'0" x 6'8" (7'0")

## SALINAS®



371HD

2'6" x 6'8" (7'0")  
2'8" x 6'8" (7'0")  
2'10" x 6'8" (7'0")  
3'0" x 6'8" (7'0")

## MAPLE PARK®



1008HD

2'6" x 6'8" (7'0")  
2'8" x 6'8" (7'0")  
2'10" x 6'8" (7'0")  
3'0" x 6'8" (7'0")

## SARATOGA™



615HD

2'6" x 6'8" (7'0")  
2'8" x 6'8" (7'0")  
2'10" x 6'8" (7'0")  
3'0" x 6'8" (7'0")

## WELLESLEY™



625HD

2'6" x 6'8" (7'0")  
2'8" x 6'8" (7'0")  
2'10" x 6'8" (7'0")  
3'0" x 6'8" (7'0")

## RISERVA®



588HD

2'6" x 6'8" (7'0")  
2'8" x 6'8" (7'0")  
2'10" x 6'8" (7'0")  
3'0" x 6'8" (7'0")

## CONCORDE™



430HD

2'6" x 6'8" (7'0")  
2'8" x 6'8" (7'0")  
2'10" x 6'8" (7'0")  
3'0" x 6'8" (7'0")

## KENSINGTON™



628HD

2'6" x 6'8" (7'0")  
2'8" x 6'8" (7'0")  
2'10" x 6'8" (7'0")  
3'0" x 6'8" (7'0")

## PEMBRIDGE™



6572HD

2'6" x 6'8" (7'0")  
2'8" x 6'8" (7'0")  
2'10" x 6'8" (7'0")  
3'0" x 6'8" (7'0")

## AXIS®



1662HD

2'6" x 6'8" (7'0")  
2'8" x 6'8" (7'0")  
2'10" x 6'8" (7'0")  
3'0" x 6'8" (7'0")

## CALIX



396HD

2'6" x 6'8" (7'0")  
2'8" x 6'8" (7'0")  
2'10" x 6'8" (7'0")  
3'0" x 6'8" (7'0")

## PRIVACY & TEXTURED GLASS



263HD\_

2'6" x 6'8" (7'0")  
2'8" x 6'8" (7'0")  
2'10" x 6'8" (7'0")  
3'0" x 6'8" (7'0")



289HD\_

2'8" x 6'8" (7'0")  
2'10" x 6'8" (7'0")  
3'0" x 6'8" (7'0")

### Privacy & Textured Glass Options

Add the code to the blank in the style number for the desired door and glass combination. For details on glass options, see page 220.

XK = Reeded

XE = Satin Etch

XC = Chord

XJ = Chinchilla

XR = Rainglass

XN = Granite

### CLEAR GLASS WITH DIVIDED LITES



**263HD**  
  
 2'6" x 6'8" (7'0")  
 2'8" x 6'8" (7'0")  
 2'10" x 6'8" (7'0")  
 3'0" x 6'8" (7'0")



**1411HD**  
  
 2'6" x 6'8" (7'0")  
 2'8" x 6'8" (7'0")  
 2'10" x 6'8" (7'0")  
 3'0" x 6'8" (7'0")

### CLEAR GLASS



**289HD**  
  
 2'6" x 6'8" (7'0")  
 2'8" x 6'8" (7'0")  
 2'10" x 6'8" (7'0")  
 3'0" x 6'8" (7'0")

## Craftsman Lites

### SEDONA



**604HD**  
  
 2'8" x 6'8"  
 2'10" x 6'8"  
 3'0" x 6'8"

### MAPLE PARK



**609HD**  
  
 2'8" x 6'8"  
 2'10" x 6'8"  
 3'0" x 6'8"

### SARATOGA™



**602HD**  
  
 2'8" x 6'8"  
 2'10" x 6'8"  
 3'0" x 6'8"

### RISERVA



**508HD**  
  
 2'8" x 6'8"  
 2'10" x 6'8"  
 3'0" x 6'8"

### PEMBRIDGE™



**6520HD**  
  
 2'8" x 6'8"  
 2'10" x 6'8"  
 3'0" x 6'8"

### AXIS



**1650HD**  
  
 2'8" x 6'8"  
 2'10" x 6'8"  
 3'0" x 6'8"

### CALIX



**6975HD**  
  
 2'8" x 6'8"  
 2'10" x 6'8"  
 3'0" x 6'8"

### PRIVACY & TEXTURED GLASS WITH DIVIDED LITES



**605HD** \*  
  
 2'8" x 6'8"  
 2'10" x 6'8"  
 3'0" x 6'8"



**606HD** \*  
  
 2'8" x 6'8"  
 2'10" x 6'8"  
 3'0" x 6'8"



**607HD** \*  
  
 2'8" x 6'8"  
 2'10" x 6'8"  
 3'0" x 6'8"



**608HD** \*  
  
 2'8" x 6'8"  
 2'10" x 6'8"  
 3'0" x 6'8"

### Key

- Low-E Glass (LE)
- Black Nickel Caming (1D)
- Brushed Nickel Caming (1C)
- Brass Caming (1A)
- Wrought Iron (1W)
- Simulated Divided Lites (SDL)
- Flat or Contour White Grilles Between Glass (GBGF / GBGC)
- Flat Almond Grilles Between Glass (GBGF)
- Flat Bronze Grilles Between Glass (GBGF)
- Flat or Contour Black Grilles Between Glass (GBGF / GBGC)
- Fixed Grilles (FXG)
- Flat Lite Frame
- Scrolled & Flat Advanta Lite Frame  
Not available for 2'4" and 2'6" doors or 10" sidelites.
- WBDR / HVHZ Options

**PRIVACY & TEXTURED GLASS**



601\_HD\*  
 2'8" x 6'8"  
 2'10" x 6'8"  
 3'0" x 6'8"

**CLEAR GLASS WITH DIVIDED LITES**



605HD  
 2'8" x 6'8"  
 2'10" x 6'8"  
 3'0" x 6'8"



606HD  
 2'8" x 6'8"  
 2'10" x 6'8"  
 3'0" x 6'8"



607HD  
 2'8" x 6'8"  
 2'10" x 6'8"  
 3'0" x 6'8"



608HD  
 2'8" x 6'8"  
 2'10" x 6'8"  
 3'0" x 6'8"

**CLEAR GLASS**



601HD  
 2'8" x 6'8"  
 2'10" x 6'8"  
 3'0" x 6'8"

**Minimal Lites**

**MAPLE PARK** ◆ ◆ ◆



736HD  
 2'8" x 6'8" (7'0")  
 2'10" x 6'8" (7'0")  
 3'0" x 6'8" (7'0")

**SARATOGA**™ ◆ ◆ ◆



707HD  
 2'8" x 6'8" (7'0")  
 2'10" x 6'8" (7'0")  
 3'0" x 6'8" (7'0")

**WELLESLEY**™ ◆ ◆ ◆ ◆



721HD  
 2'8" x 6'8" (7'0")  
 2'10" x 6'8" (7'0")  
 3'0" x 6'8" (7'0")

**CONCORDE**™ ◆ ◆ ◆ ◆



735HD  
 2'8" x 6'8" (7'0")  
 2'10" x 6'8" (7'0")  
 3'0" x 6'8" (7'0")

**PEMBRIDGE**™ ◆ ◆ ◆ ◆



745HD  
 2'8" x 6'8" (7'0")  
 2'10" x 6'8" (7'0")  
 3'0" x 6'8" (7'0")

**CLEAR GLASS WITH DIVIDED LITES**



752HD  
 2'8" x 6'8" (7'0")  
 2'10" x 6'8" (7'0")  
 3'0" x 6'8" (7'0")



704HD  
 2'8" x 6'8" (7'0")  
 2'10" x 6'8" (7'0")  
 3'0" x 6'8" (7'0")

**CLEAR GLASS**



708HD  
 2'8" x 6'8" (7'0")  
 2'10" x 6'8" (7'0")  
 3'0" x 6'8" (7'0")

**CONCORDE**™ ◆ ◆ ◆ ◆



454HD  
 2'8" x 6'8" (7'0")  
 2'10" x 6'8" (7'0")  
 3'0" x 6'8" (7'0")

**Privacy & Textured Glass Options**

Add the code to the blank in the style number for the desired door and glass combination. For details on glass options, see page 220.

XK = Reeded

XE = Satin Etch

XC = Chord

XJ = Chinchilla

XR = Rainglass

XN = Granite

\*Not available with Reeded (XK) glass.

Note: See page 285 for important product details that may help with your purchase decision.



**CLEAR GLASS WITH DIVIDED LITES**



**255HD**  
 \* ♦ ♦ ♦ ♦  
 2'8" x 6'8" (7'0")  
 2'10" x 6'8" (7'0")  
 3'0" x 6'8" (7'0")

**CLEAR GLASS**



**256HD**  
 \*  
 2'8" x 6'8" (7'0")  
 2'10" x 6'8" (7'0")  
 3'0" x 6'8" (7'0")

**CLEAR GLASS WITH DIVIDED LITES**



**236HD**  
 ♦  
 2'8" x 6'8" (7'0")  
 2'10" x 6'8" (7'0")  
 3'0" x 6'8" (7'0")



**237HD**  
 \* ♦  
 2'8" x 6'8" (7'0")  
 2'10" x 6'8" (7'0")  
 3'0" x 6'8" (7'0")  
 (Scalloped Lite Frame)

**PEMBRIDGE™**



**6570HD**  
 ▲  
 2'8" x 6'8" (7'0")  
 2'10" x 6'8" (7'0")  
 3'0" x 6'8" (7'0")



**6570SLHD**  
 ▲  
 12" x 6'8" (7'0")  
 14" x 6'8" (7'0")

**AXIS. ♦**



**1643HD**  
 ▲  
 2'8" x 6'8" (7'0")  
 2'10" x 6'8" (7'0")  
 3'0" x 6'8" (7'0")



**1643SLHD**  
 ▲  
 12" x 6'8" (7'0")  
 14" x 6'8" (7'0")

**PRIVACY & TEXTURED GLASS**



**296HD**  
 ▲  
 2'8" x 6'8" (7'0")  
 2'10" x 6'8" (7'0")  
 3'0" x 6'8" (7'0")



**296SLHD**  
 ▲  
 12" x 6'8" (7'0")  
 14" x 6'8" (7'0")

**CLEAR GLASS**



**296HD**  
 \* ▲  
 2'8" x 6'8" (7'0")  
 2'10" x 6'8" (7'0")  
 3'0" x 6'8" (7'0")



**296SLHD**  
 \* ▲  
 12" x 6'8" (7'0")  
 14" x 6'8" (7'0")

**Solid Panel**



**969HD**  
 6  
 2'8" x 6'8"  
 2'10" x 6'8"  
 3'0" x 6'8"



**978HD**  
 6  
 2'8" x 6'8"  
 2'10" x 6'8"  
 3'0" x 6'8"



**1005HD**  
 6  
 2'8" x 6'8"  
 2'10" x 6'8"  
 3'0" x 6'8"



**205HD**  
 6  
 2'8" x 6'8"  
 2'10" x 6'8"  
 3'0" x 6'8"



**203HD**  
 6  
 2'8" x 6'8"  
 2'10" x 6'8"  
 3'0" x 6'8"



**210HD**  
 6  
 2'6" x 6'8" (7'0")  
 2'8" x 6'8" (7'0")  
 2'10" x 6'8" (7'0")  
 3'0" x 6'8" (7'0")



**100**  
 6 E  
 2'0" x 6'8"  
 2'4" x 6'8"  
 2'6" x 6'8" (7'0")  
 2'8" x 6'8" (7'0")  
 2'10" x 6'8" (7'0")  
 3'0" x 6'8" (7'0")  
 3'6" x 6'8" (7'0")

**Key**

- ☀ Low-E Glass (LE)
- ◆ Black Nickel Caming (1D)
- Brushed Nickel Caming (1C)
- ◆ Brass Caming (1A)
- 🏠 Simulated Divided Lites (SDL)
- ♦ Flat or Contour White Grilles Between Glass (GBGF / GBGC)
- ♦ Flat Almond Grilles Between Glass (GBGF)
- ◆ Flat Bronze Grilles Between Glass (GBGF)
- ◆ Fixed Grilles (FXG)
- ▲ Flat Lite Frame
- ▲ Scrolled & Flat Advanta Lite Frame  
Not available for 2'4" and 2'6" doors or 10" sidelites.
- ▲ Scrolled Advanta Lite Frame  
Not available for 2'4" and 2'6" doors or 10" sidelites.
- 6 WBDR / HVHZ Options
- E Elevated 10" Bottom Rail Options

# Full Lites

## PRIVACY & TEXTURED GLASS WITH DIVIDED LITES

					
<b>TS128_</b> 2'8" x 6'8" 2'10" x 6'8" 3'0" x 6'8"	<b>TS108_</b> 2'8" x 6'8" 2'10" x 6'8" 3'0" x 6'8"	<b>6184_SL*</b> 10" x 6'8" 12" x 6'8" (7'0") 14" x 6'8" (7'0")	<b>6185_SL*</b> 10" x 6'8" 12" x 6'8" (7'0") 14" x 6'8" (7'0")	<b>6186_SL*</b> 10" x 6'8" 12" x 6'8" (7'0") 14" x 6'8" (7'0")	<b>632_SL</b> 10" x 6'8" 12" x 6'8" (7'0") 14" x 6'8" (7'0")

## PRIVACY & TEXTURED GLASS

	
<b>TS118_</b> 2'8" x 6'8" 2'10" x 6'8" 3'0" x 6'8"	<b>818_</b> 2'8" x 8'0" 2'10" x 8'0" 3'0" x 8'0"

## PRIVACY & TEXTURED GLASS

	
<b>100_SL</b> 10" x 6'8" 12" x 6'8" (7'0") 14" x 6'8" (7'0")	<b>818_SL</b> 12" x 8'0" 14" x 8'0"

## INTERNAL BLINDS

			
<b>TS130</b> 2'4" x 6'8" 2'6" x 6'8" 2'8" x 6'8" 2'10" x 6'8" 2'10" x 6'8" 3'0" x 6'8"	<b>829</b> 2'6" x 8'0" 2'8" x 8'0" 2'10" x 8'0" 3'0" x 8'0"	<b>130SL</b> 10" x 6'8" 12" x 6'8" (7'0") 14" x 6'8" (7'0")	<b>829SL</b> 12" x 8'0" 14" x 8'0"

## CLEAR GLASS WITH DIVIDED LITES

		
<b>TS1201</b> 2'6" x 6'8" 2'8" x 6'8" 2'10" x 6'8" 3'0" x 6'8"	<b>TS1202</b> 2'6" x 6'8" 2'8" x 6'8" 2'10" x 6'8" 3'0" x 6'8"	<b>TS1203</b> 2'6" x 6'8" 2'8" x 6'8" 2'10" x 6'8" 3'0" x 6'8"

							
<b>TS128</b> 2'6" x 6'8" 2'8" x 6'8" 2'10" x 6'8" 3'0" x 6'8"	<b>TS1200</b> 2'6" x 6'8" 2'8" x 6'8" 2'10" x 6'8" 3'0" x 6'8"	<b>TS108</b> 2'6" x 6'8" 2'8" x 6'8" 2'10" x 6'8" 3'0" x 6'8"	<b>828</b> 2'6" x 8'0" 2'8" x 8'0" 2'10" x 8'0" 3'0" x 8'0"	<b>808</b> 2'6" x 8'0" 2'8" x 8'0" 2'10" x 8'0" 3'0" x 8'0"	<b>1201SL</b> 10" x 6'8" 12" x 6'8" (7'0") 14" x 6'8" (7'0")	<b>1202SL</b> 10" x 6'8" 12" x 6'8" (7'0") 14" x 6'8" (7'0")	<b>1200SL</b> 10" x 6'8" 12" x 6'8" (7'0") 14" x 6'8" (7'0")

### Privacy & Textured Glass Options

Add the code to the blank in the style number for the desired door and glass combination. For details on glass options, see page 220.

XK = Reeded    XC = Chord    XR = Rainglass  
XE = Satin Etch    XJ = Chinchilla    XN = Granite

\*Not available with Reeded (XK) glass.

\*\*Available with Impact-rated lite frame only.

Note: See page 285 for important product details that may help with your purchase decision.



<b>632SL</b>  10" x 6'8" 12" x 6'8" (7'0") 14" x 6'8" (7'0")	<b>828SL</b>  12" x 8'0" 14" x 8'0"	<b>6184SL</b>  10" x 6'8" 12" x 6'8" (7'0") 14" x 6'8" (7'0")	<b>86184SL</b>  12" x 8'0" 14" x 8'0"	<b>6185SL</b>  10" x 6'8" 12" x 6'8" (7'0") 14" x 6'8" (7'0")	<b>86185SL</b>  12" x 8'0" 14" x 8'0"	<b>6186SL</b>  10" x 6'8" 12" x 6'8" (7'0") 14" x 6'8" (7'0")	<b>86186SL</b>  12" x 8'0" 14" x 8'0"
--	--	---	--	---	--	---	--

**CLEAR GLASS**



<b>TS198</b>  2'6" x 6'8" 2'8" x 6'8" 2'10" x 6'8" 3'0" x 6'8"	<b>198SL</b>  10" x 6'8" 12" x 6'8" (7'0") 14" x 6'8" (7'0")	<b>TS118</b>  2'0" x 6'8"*** 2'4" x 6'8"*** 2'6" x 6'8"*** 2'8" x 6'8" 2'10" x 6'8" 3'0" x 6'8"	<b>818</b>  2'0" x 8'0"*** 2'6" x 8'0"*** 2'8" x 8'0" 2'10" x 8'0" 3'0" x 8'0"	<b>100SL</b>  10" x 6'8" 12" x 6'8" (7'0") 14" x 6'8" (7'0")	<b>818SL</b>  12" x 8'0" 14" x 8'0"
---	--	--	--	--	--

**1/2 Lites**

**PRIVACY & TEXTURED GLASS WITH DIVIDED LITES**



<b>TS262_</b>  2'8" x 6'8" 2'10" x 6'8" 3'0" x 6'8"	<b>8321_</b>  2'8" x 8'0" 2'10" x 8'0" 3'0" x 8'0"	<b>TS263_SL</b>  12" x 6'8" 14" x 6'8"
---	--	---

**PRIVACY & TEXTURED GLASS**



<b>TS206_</b>  2'8" x 6'8" 2'10" x 6'8" 3'0" x 6'8"	<b>8206_</b>  2'8" x 8'0" 2'10" x 8'0" 3'0" x 8'0"	<b>TS104_</b>  2'8" x 6'8" 2'10" x 6'8" 3'0" x 6'8"	<b>TS210_SL</b>  12" x 6'8" 14" x 6'8"
---	--	---	---

**Key**

- Low-E Glass (LE)
- Turtle Glass
- Simulated Divided Lites (SDL)
- Flat or Contour White Grilles Between Glass (GBGF / GBGC)
- Flat Almond Grilles Between Glass (GBGF)
- Flat Bronze Grilles Between Glass (GBGF)
- Flat or Contour Black Grilles Between Glass (GBGF / GBGC)
- Fixed Grilles (FXG)
- Scrolled & Flat Advanta Lite Frame  
Not available for 2'4" and 2'6" doors or 10" sidelites.
- Scrolled Advanta Lite Frame  
Not available for 2'4" and 2'6" doors or 10" sidelites.
- WBDR / HVHZ Options
- Elevated 10" Bottom Rail Options

### INTERNAL BLINDS



- |  |  |  |   |
|--|--|--|---|
| <b>TS132</b><br>* 6<br>2'6" x 6'8"<br>2'8" x 6'8"<br>2'10" x 6'8"<br>3'0" x 6'8" | <b>8132</b><br>* 6<br>2'8" x 8'0"<br>2'10" x 8'0"<br>3'0" x 8'0" | <b>TS131</b><br>* 6 E<br>2'6" x 6'8"<br>2'8" x 6'8"<br>2'10" x 6'8"<br>3'0" x 6'8" | <b>TS132SL</b><br>* 6<br>12" x 6'8"<br>14" x 6'8" |
|--|--|--|---|

### SCREEN VENTED LITES\*



- |  |   |
|--|---|
| <b>TS243</b><br>2'8" x 6'8"<br>2'10" x 6'8"<br>3'0" x 6'8" | <b>TS137</b><br>E<br>2'8" x 6'8"<br>2'10" x 6'8"<br>3'0" x 6'8" |
|--|---|

### CLEAR GLASS WITH DIVIDED LITES



- |  |  |  |  |  |  |   |
|--|--|--|--|--|--|---|
| <b>8322</b><br>* 6<br>2'8" x 8'0"<br>2'10" x 8'0"<br>3'0" x 8'0" | <b>8323</b><br>* 6<br>2'8" x 8'0"<br>2'10" x 8'0"<br>3'0" x 8'0" | <b>8324</b><br>* 6<br>2'8" x 8'0"<br>2'10" x 8'0"<br>3'0" x 8'0" | <b>TS262</b><br>* 6<br>2'6" x 6'8"<br>2'8" x 6'8"<br>2'10" x 6'8"<br>3'0" x 6'8" | <b>8321</b><br>* 6<br>2'8" x 8'0"<br>2'10" x 8'0"<br>3'0" x 8'0" | <b>TS115</b><br>E<br>2'6" x 6'8"<br>2'8" x 6'8"<br>2'10" x 6'8"<br>3'0" x 6'8" | <b>TS263SL</b><br>* 6<br>12" x 6'8"<br>14" x 6'8" |
|--|--|--|--|--|--|---|

### CLEAR GLASS



- |   |  |  |  |  |  |  |   |
|---|--|--|--|--|--|--|---|
| <b>TS1408</b><br>* 6<br>2'6" x 6'8"<br>2'8" x 6'8"<br>2'10" x 6'8"<br>3'0" x 6'8" | <b>8145</b><br>* 6<br>2'8" x 8'0"<br>2'10" x 8'0"<br>3'0" x 8'0" | <b>TS1405SL</b><br>* 6<br>12" x 6'8"<br>14" x 6'8" | <b>TS206</b><br>* 6<br>2'6" x 6'8"<br>2'8" x 6'8"<br>2'10" x 6'8"<br>3'0" x 6'8" | <b>8206</b><br>* 6<br>2'8" x 8'0"<br>2'10" x 8'0"<br>3'0" x 8'0" | <b>TS104</b><br>* 6 E<br>2'6" x 6'8"<br>2'8" x 6'8"<br>2'10" x 6'8"<br>3'0" x 6'8" ⚠ | <b>TS105</b><br>E<br>2'6" x 6'8"<br>2'8" x 6'8"<br>2'10" x 6'8"<br>3'0" x 6'8" ⚠ | <b>TS210SL</b><br>* 6<br>12" x 6'8"<br>14" x 6'8" |
|---|--|--|--|--|--|--|---|

#### Privacy & Textured Glass Options

Add the code to the blank in the style number for the desired door and glass combination. For details on glass options, see page 220.

- |                        |                        |                       |
|------------------------|------------------------|-----------------------|
| <b>XK = Reeded</b>     | <b>XC = Chord</b>      | <b>XR = Rainglass</b> |
| <b>XE = Satin Etch</b> | <b>XJ = Chinchilla</b> | <b>XN = Granite</b>   |

\*Features a gliding operation and sash locking system.  
Note: See page 285 for important product details that may help with your purchase decision.

# Twin 1/2 Lites

## PRIVACY & TEXTURED GLASS WITH DIVIDED LITES



TS263\_   
 2'6" x 6'8"   
 2'8" x 6'8"   
 2'10" x 6'8"   
 3'0" x 6'8"

## PRIVACY & TEXTURED GLASS



TS289\_   
 2'6" x 6'8"   
 2'8" x 6'8"   
 2'10" x 6'8"   
 3'0" x 6'8"

## CLEAR GLASS WITH DIVIDED LITES



TS263   
 2'6" x 6'8"   
 2'8" x 6'8"   
 2'10" x 6'8"   
 3'0" x 6'8"



TS1411   
 2'6" x 6'8"   
 2'8" x 6'8"   
 2'10" x 6'8"   
 3'0" x 6'8"

## CLEAR GLASS



TS289   
 2'6" x 6'8"   
 2'8" x 6'8"   
 2'10" x 6'8"   
 3'0" x 6'8"



# Minimal Lites

## PRIVACY & TEXTURED GLASS



TS296\_ 896\_ TS296\_SL   
 2'8" x 6'8" 2'8" x 8'0" 12" x 6'8"   
 2'8" x 6'8" 2'10" x 8'0" 14" x 6'8"   
 2'10" x 6'8" 3'0" x 8'0"   
 3'0" x 6'8"

## CLEAR GLASS WITH DIVIDED LITES



TS752 8752 TS704 8704 TS255 TS236 8317   
 2'8" x 6'8" 2'8" x 8'0" 2'8" x 8'0" 2'8" x 8'0" 2'8" x 6'8" 2'8" x 8'0"   
 2'10" x 6'8" 2'10" x 8'0" 2'10" x 6'8" 2'10" x 8'0" 2'10" x 6'8" 2'10" x 8'0"   
 3'0" x 6'8" 3'0" x 8'0" 3'0" x 6'8" 3'0" x 8'0" 3'0" x 6'8" 3'0" x 8'0"

CLEAR GLASS WITH DIVIDED LITES *Continues on next page.*

### Key

- Low-E Glass (LE)
- Simulated Divided Lites (SDL)
- Flat or Contour White Grilles Between Glass (GBGF / GBGC)
- Flat Almond Grilles Between Glass (GBGF)
- Flat or Contour Black Grilles Between Glass (GBGF / GBGC)
- Scrolled & Flat Advanta Lite Frame Not available for 2'4" and 2'6" doors or 10" sidelites.
- Elevated 10" Bottom Rail Options
- 6'6" Height Available
- WBDH / HVHZ Options
- Fixed Grilles (FXG)
- Scrolled Advanta Lite Frame Not available for 2'4" and 2'6" doors or 10" sidelites.

**CLEAR GLASS WITH DIVIDED LITES**



**TS237**  
 \* ◆  
 2'8" x 6'8"  
 2'10" x 6'8"  
 3'0" x 6'8"  
 (Scalloped Lite Frame)

**CLEAR GLASS**



**TS708** | **8708**  
 \* | \*  
 2'8" x 6'8" | 2'8" x 8'0"  
 2'10" x 6'8" | 2'10" x 8'0"  
 3'0" x 6'8" | 3'0" x 8'0"



**TS256**  
 \*  
 2'8" x 6'8"  
 2'10" x 6'8"  
 3'0" x 6'8"



**TS296** | **896**  
 \* ▲ | \* ▲  
 2'6" x 6'8" | 2'8" x 8'0"  
 2'8" x 6'8" | 2'10" x 8'0"  
 2'10" x 6'8" | 3'0" x 8'0"  
 3'0" x 6'8"



**TS296SL**  
 \* ▲  
 12" x 6'8"  
 14" x 6'8"

**Solid Panel**



**TS210** | **810**  
 6 | 6  
 2'6" x 6'8" | 2'6" x 8'0"  
 2'8" x 6'8" | 2'8" x 8'0"  
 2'10" x 6'8" | 2'10" x 8'0"  
 3'0" x 6'8" | 3'0" x 8'0"

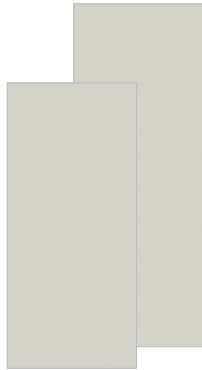

**TS100** | **800**  
 6E | 6E  
 2'0" x 6'8" | 2'0" x 8'0"  
 2'4" x 6'8" | 2'4" x 8'0"  
 2'6" x 6'8" | 2'6" x 8'0"  
 2'8" x 6'8" | 2'8" x 8'0"  
 2'10" x 6'8" | 2'10" x 8'0"  
 3'0" x 6'8" | 3'0" x 8'0"

# Transoms

Transoms can be painted to match a Profiles™ or Traditions door system.

## BLACKSTONE. ◆ ◆ ◆



BSRT  
3'0" door + (2) 12" sidelites  
Continuous Sill Systems Only

## SEDONA ◆ ◆ ◆

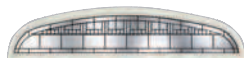

19055T  
3'0" door + (2) 12" sidelites  
3'0" door + (2) 14" sidelites  
Continuous Sill Systems Only



19520T  
3'0" door + (2) 12" sidelites  
3'0" door + (2) 14" sidelites  
Continuous Sill Systems Only

## SALINAS. ✗



SART  
3'0" door + (2) 12" sidelites  
Continuous Sill Systems Only

## MAPLE PARK. ◆ ◆ ◆



FWRT  
3'0" door + (2) 12" sidelites  
3'0" door + (2) 14" sidelites  
Continuous Sill Systems Only

## SARATOGA. ◆ ◆ ◆



19750T  
3'0" door + (2) 12" sidelites  
Continuous Sill Systems Only



19740T  
3'0" Door Only

## WELLESLEY. ◆ ◆ ◆ ◆



19730T  
3'0" door + (2) 12" sidelites  
Continuous Sill Systems Only



19720T  
3'0" Door Only

## RISERVA. ✗

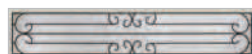

RSRT  
3'0" door + (2) 12" sidelites  
3'0" door + (2) 14" sidelites  
Continuous Sill Systems Only

## CONCORDE. ◆ ◆ ◆ ◆



CNRT  
3'0" door + (2) 12" sidelites  
3'0" door + (2) 14" sidelites  
Continuous Sill Systems Only

## KENSINGTON. ◆ ◆ ◆



KNRT  
3'0" door + (2) 12" sidelites  
3'0" door + (2) 14" sidelites  
Continuous Sill Systems Only

## PEMBRIDGE. ◆ ◆ ◆ ◆



PBRT  
3'0" door + (2) 12" sidelites  
3'0" door + (2) 14" sidelites  
Continuous / Boxed Sill Systems

## AXIS. ◆



AXRT  
3'0" door + (2) 12" sidelites  
3'0" door + (2) 14" sidelites  
Continuous / Boxed Sill Systems

## CALIX. ◆ ◆ ◆ ◆



CXRT  
3'0" door + (2) 12" sidelites  
Continuous / Boxed Sill Systems



CX30T  
3'0" Door Only

## LATITUDE. ◆ ◆ ◆ ◆



LTRT  
3'0" door + (2) 12" sidelites  
Continuous / Boxed Sill Systems



LT30T  
3'0" Door Only

## ECHELON. ◆ ◆ ◆ ◆



ECRT  
3'0" door + (2) 12" sidelites  
Continuous / Boxed Sill Systems



EC30T  
3'0" Door Only

## CLEAR GLASS



Grille Sticks Applied



19020T

\*  
3'0" door + (2) 12" sidelites  
Continuous Sill Systems Only  
3'0" door + (2) 14" sidelites  
Continuous / Boxed Sill Systems



Grille Sticks Applied



19220T

\*  
3'0" door + (2) 12" sidelites  
3'0" door + (2) 14" sidelites  
Continuous / Boxed Sill Systems



Grille Sticks Applied



19200T

\*  
3'0" Door Only



19210T

\*  
12" & 14" Sidelite Only

### Key

- ★ Low-E Glass (LE)
- ◆ Black Nickel Caming (1D)
- ◆◆ Brushed Nickel Caming (1C)
- ◆◆◆ Brass Caming (1A)
- ✗ Wrought Iron (1W)
- ◆ Fixed Grilles (FXG)
- ◆ Scrolled & Flat Advanta Lite Frame  
Not available for 2'4" and 2'6" doors or 10" sidelites.
- ⚡ WBDR / HVHZ Options
- E Elevated 10" Bottom Rail Options

# Fire Doors

Smooth-Star® & Steel



Therma-Tru offers an industry-leading selection of Fire-rated doors certified to carry the Warnock Hersey Mark.





## Therma-Tru® Fire-Rated Doors

Therma-Tru offers products to meet most national and local code requirements for house-to-garage, multi-family residential and hotel / motel unit entries.\* Explore a wide variety of 20-minute Fire-rated fiberglass and steel door styles.

- Smooth-Star® 20-minute Fire-rated fiberglass doors are constructed with a polyurethane foam core that reduces overall door slab weight by 45% for easier handling and installation.\*\*

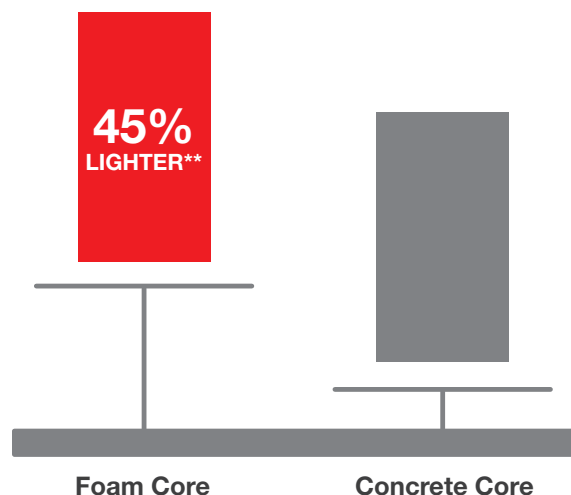

## 20-Minute Fire-Rated Fiberglass Doors

- Tested to withstand a minimum of 20-minutes of fire exposure with temperatures that reach more than 1,400 degrees Fahrenheit.
- Features a 20-minute positive pressure rating.
- Certified by Intertek, Warnock Hersey for mortise lock use and features a wide lock stile to provide proper handleset reinforcement, combined with lock and hinge stiles that increase rigidity and stability.
- More durable than steel, and resist dents, scratches and rust, making them ideal for high-traffic, heavy-use environments.
- Features full-length lock side blocking, as well as blocking for panic and closure applications.
- Ideal for hotels, apartments, office buildings and other applications with security locks and card readers.

### ADDITIONAL OPTIONS

- Solid-panel steel wood-edge doors also available with the 20-minute Fire-rated label, starting on page 243.

### For California Projects

Therma-Tru Smooth-Star 20-minute Fire-rated fiberglass doors meet or exceed building codes and regulations specific to the state of California, including:

- ✓ California Wildland Urban Interface (WUI) requirements.
- ✓ California Air Resources Board (CARB) formaldehyde regulations.
- ✓ California State Fire Marshall test CA SFM 12-7A-1.

### For Florida Projects









Therma-Tru Smooth-Star foam core 20-minute Fire-rated fiberglass doors include options to meet building codes and regulations specific to the state of Florida.









- ✓ Approved for structural use in Florida.
- ✓ Approved for Wind-Borne Debris Regions (WBDR).

\*To confirm fire door requirements in your jurisdiction, always check with your local building code authority.  
 \*\*Comparison of 20-minute foam core Fire-rated door to a 20-minute concrete core Fire-rated door with similar style.  
 Note: To see the third-party Intertek (Warnock-Hersey) listing reports, visit [thermatru.com/performance](http://thermatru.com/performance).  
 Left: Smooth-Star Door – SSF120



## 20-Minute Fire-Rated Wood Edge – Fiberglass

							
Smooth	Smooth	Smooth	Smooth	Smooth	Smooth	Smooth	Smooth
SSF93 6 2'8" x 6'8" 2'10" x 6'8" 3'0" x 6'8"	SSF45 6 2'8" x 6'8" 2'10" x 6'8" 3'0" x 6'8"	SSF220 6 E 2'8" x 6'8" (7'0") 2'10" x 6'8" (7'0") 3'0" x 6'8" (7'0")	SSF8220 6 E 2'8" x 8'0" 2'10" x 8'0" 3'0" x 8'0"	SSF1100 6 E 2'8" x 6'8" 2'10" x 6'8" 3'0" x 6'8"	SSF81100 6 2'8" x 8'0" 2'10" x 8'0" 3'0" x 8'0"	SSF120 6 E 2'8" x 6'8" 2'10" x 6'8" 3'0" x 6'8"	SSF8120 6 E 2'8" x 8'0" 2'10" x 8'0" 3'0" x 8'0"
		SSF200 6 2'6" x 6'8" 2'8" x 6'8" 2'10" x 6'8" 3'0" x 6'8"	SSF8200 6 2'8" x 8'0" 2'10" x 8'0" 3'0" x 8'0"				

							
Smooth	Smooth	Smooth	Smooth	Smooth	Smooth	Smooth	Smooth
SSF205 6 2'8" x 6'8" 2'10" x 6'8" 3'0" x 6'8"	SSF8205 6 2'8" x 8'0" 2'10" x 8'0" 3'0" x 8'0"	SSF755 6 2'10" x 6'8" 3'0" x 6'8"	SSF31 6 2'8" x 6'8" 2'10" x 6'8" 3'0" x 6'8"	SSF831 6 2'8" x 8'0" 2'10" x 8'0" 3'0" x 8'0"	SSF960 6 2'8" x 6'8" 2'10" x 6'8" 3'0" x 6'8"	SSF4800 6 E 2'8" x 6'8" 2'10" x 6'8" 3'0" x 6'8"	SSF84800 6 2'8" x 8'0" 2'10" x 8'0" 3'0" x 8'0"

Note: See page 285 for important product details that may help with your purchase decision.

Top Left: Smooth-Star Door – SSF45, Finish – Alpine

Top Right: Smooth-Star Door – SSF220

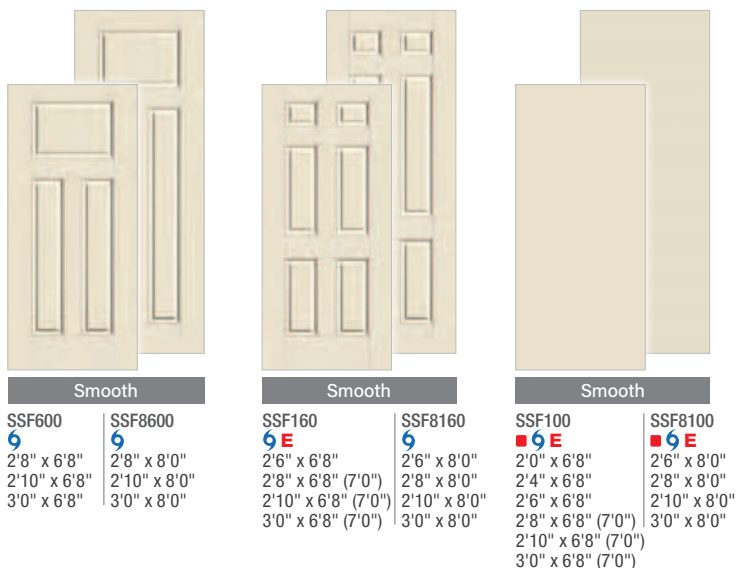

## 20-Minute Fire-Rated Wood Edge – Steel

### PROFILES™



### TRADITIONS



### Key

- No Stile Lines
- WBDR Options

- WBDR / HVHZ Options
- Elevated 10" Bottom Rail Options



Clean lines. Crisp angles. Sleek designs. Vintage style. Pulse is a contemporary series of door styles and glass designs that can be combined to make a bold statement. With three distinct aesthetic approaches – Ari, Línea and Echo – the entrance becomes modern art.

\*Please verify that there is a Therma-Tru Impact-rated product approval for the configuration before buying.  
Note: Finish colors may vary from an actual application due to fluctuations in finishing or printing. Glass designs may differ from depiction due to size and hand craftsmanship of glass. See your Therma-Tru seller or visit [thermatru.com](http://thermatru.com) for more, including details on limited warranties and exclusions, ENERGY STAR qualified products and product approvals.

## It's your decision, by design.

Pulse is geometry with energy. Designed to be fun and easy to mix and match with sleek, flush door and sidelite styles, you can create a modern entrance without missing a beat. Explore all the possible combinations at [thermatru.com/pulse](http://thermatru.com/pulse). Mix and match to get the style numbers needed to order. Turn the page for a glimpse of available styles and sizes.

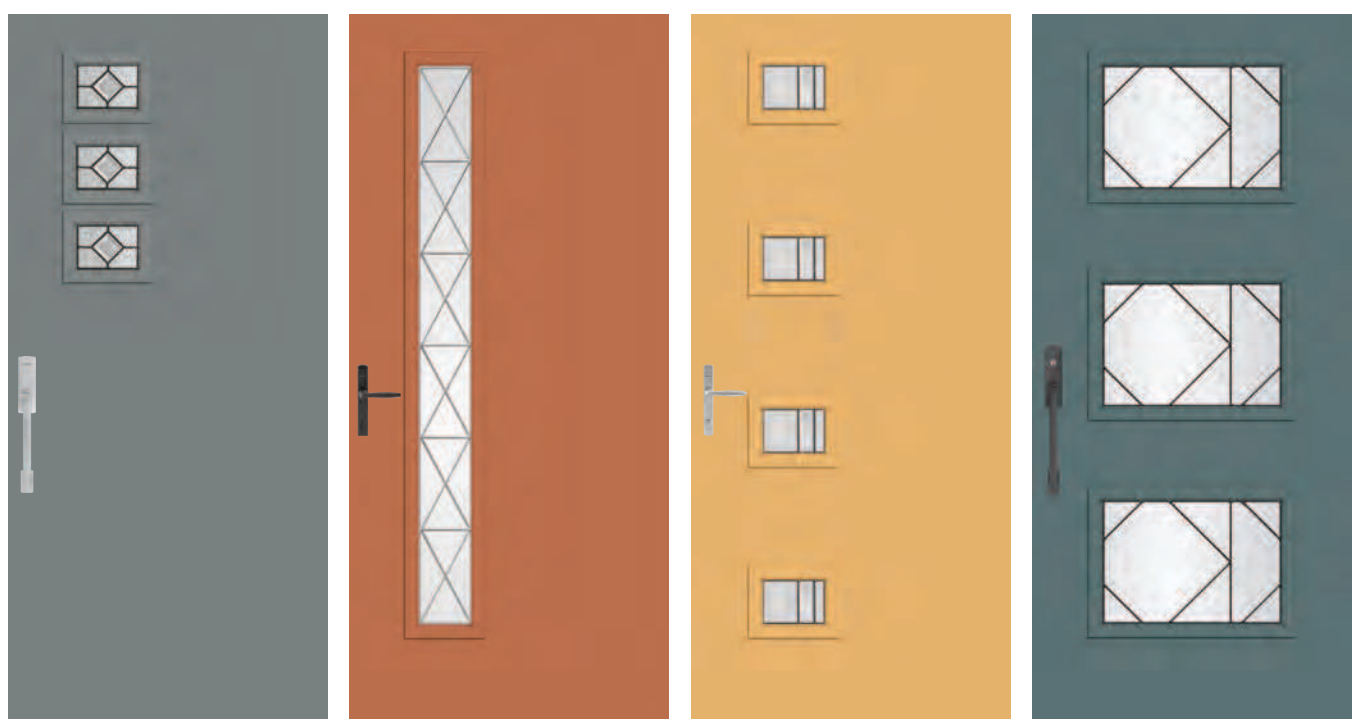

## The creativity is unlimited. Stain or paint the entrance any color.

These doors and sidelites come ready to stain or paint. So there's no limit to the creativity you can use when it comes to finishing touches.



Fiberglass



Steel



 WBDR / HVHZ Options:  
Look for this icon to find door styles that can be configured for WBDR or HVHZ.\*

### 1 START WITH A STYLE

Combine doors and sidelites to create an entrance that fits your vision.

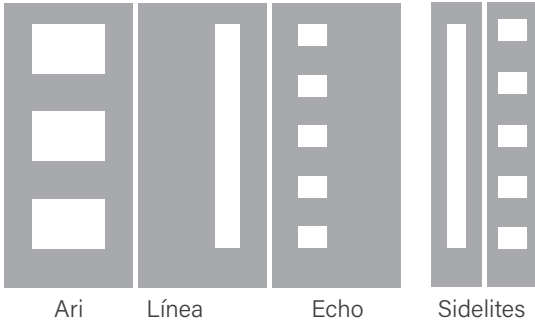

### 2 CHOOSE A MATERIAL

Each style is available in any of these material choices.

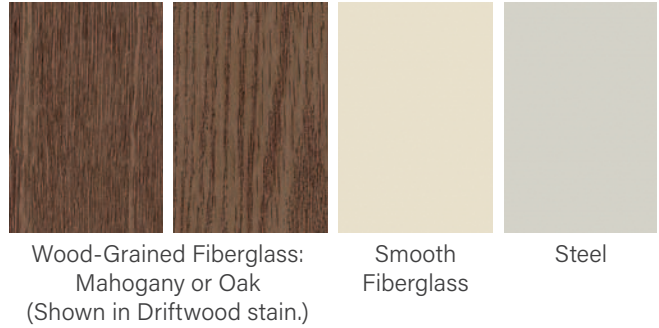

### 3 SELECT A GLASS

Find an available glass design to complete the statement you want to make.

#### Privacy & Textured Glass

Available for all Pulse door styles.

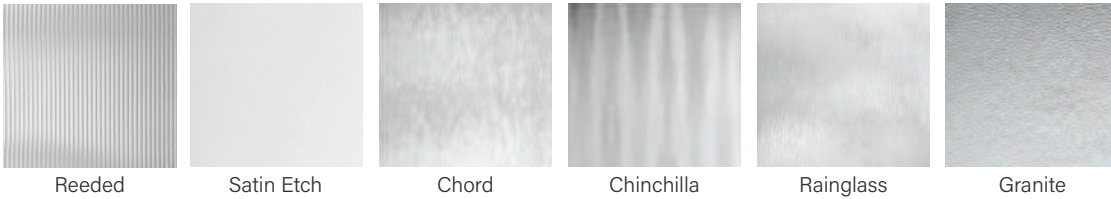

Low-E also available.

#### Decorative Glass

Available for Línea.

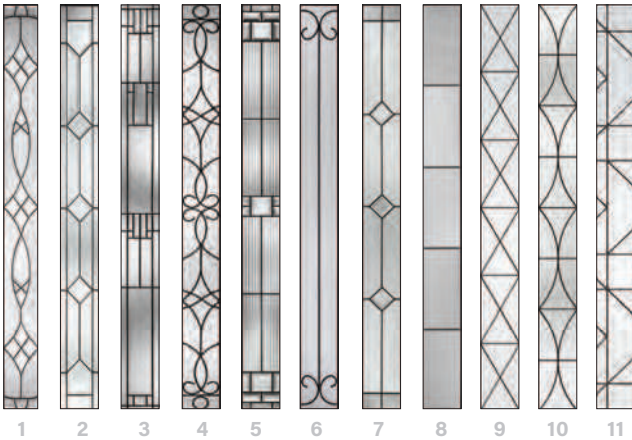

Available for Ari.

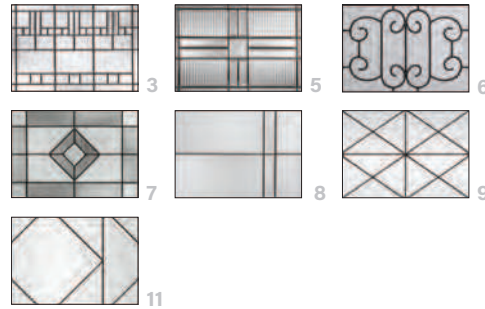

- 1 Blackstone.™
- 2 Crystalline.™
- 3 Sedona
- 4 Salinas.™
- 5 Saratoga.™
- 6 Riserva.™
- 7 Pembridge.™
- 8 Axis.™
- 9 Calix
- 10 Latitude
- 11 Echelon

Available for Echo.



### 4 THEN SELECT A FRAME

Choose the flat profile for modern appeal or scrolled profile for vintage style. Available in Advanta.\* and Standard lite frames.



Flat Profile Lite Frame

Scrolled Profile Lite Frame

\*See your Therma-Tru seller for details on product availability.

## Pulse. Size Options

	Wood-Grained Fiberglass		Smooth Fiberglass		Steel	
	6'8"	8'0"	6'8"	8'0"	6'8"	8'0"
Doors	2'6" x 6'8" ◦	2'6" x 8'0" ◦	2'6" x 6'8" ◦	2'6" x 8'0" ◦	2'6" x 6'8" ◦	2'6" x 8'0" ◦
	2'8" x 6'8"	2'8" x 8'0"	2'8" x 6'8"	2'8" x 8'0"	2'8" x 6'8"	2'8" x 8'0"
	2'10" x 6'8"	2'10" x 8'0"	2'10" x 6'8"	2'10" x 8'0"	2'10" x 6'8"	2'10" x 8'0"
	3'0" x 6'8"	3'0" x 8'0"	3'0" x 6'8"	3'0" x 8'0"	3'0" x 6'8"	3'0" x 8'0"
			3'6" x 6'8"	3'6" x 8'0"	3'6" x 6'8"	
Sidelites	10" x 6'8" •	12" x 8'0"	10" x 6'8" •	12" x 8'0"	10" x 6'8" •	12" x 8'0"
	12" x 6'8"	14" x 8'0"	12" x 6'8"	14" x 8'0"	12" x 6'8"	14" x 8'0"
	14" x 6'8"		14" x 6'8"		14" x 6'8"	

- Available in full-lite sidelites only.
- Available in Línea and Echo only.



# Ari

Note: Product images show exterior side of door.



**S2SN** | **S83SN** | **S2SG** | **S83SG** | **S2RS** | **S83RS** | **S2PB** | **S83PB** | **S2AX** | **S83AX**  
 ◆ ■ ▨ ▩ 6 | ◆ ■ ▨ ▩ 6 | ◆ ■ ▨ ▩ 6 | ◆ ■ ▨ ▩ 6 | ✕ ▨ ▩ 6 | ✕ ▨ ▩ 6 | ◆ ■ ▨ ▩ 6 | ◆ ■ ▨ ▩ 6 | ◆ ■ ▨ ▩ 6 | ◆ ■ ▨ ▩ 6

**S2CX** | **S83CX** | **S2EC** | **S83EC** | **S2** | **S83**  
 ◆ ■ ▨ ▩ 6 | ◆ ■ ▨ ▩ 6 | ◆ ■ ▨ ▩ 6 | ◆ ■ ▨ ▩ 6 | **S2CL** ✨ | **S83CL** ✨  
 ▨ ▩ 6 | ▨ ▩ 6

# Línea

Note: Product images show exterior side of door.

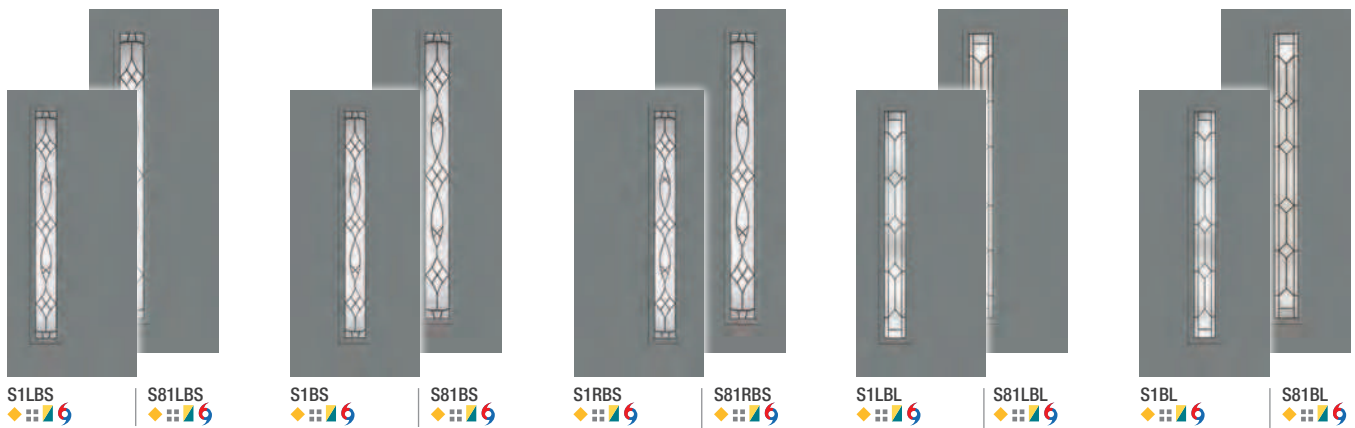

**S1LBS** | **S81LBS** | **S1BS** | **S81BS** | **S1RBS** | **S81RBS** | **S1LBL** | **S81LBL** | **S1BL** | **S81BL**  
 ◆ ■ ▨ ▩ 6 | ◆ ■ ▨ ▩ 6 | ◆ ■ ▨ ▩ 6 | ◆ ■ ▨ ▩ 6 | ◆ ■ ▨ ▩ 6 | ◆ ■ ▨ ▩ 6 | ◆ ■ ▨ ▩ 6 | ◆ ■ ▨ ▩ 6 | ◆ ■ ▨ ▩ 6 | ◆ ■ ▨ ▩ 6

**It's your decision, by design.**

Select a look for the door and sidelites. Choose a material. Find an available glass design and frame to complete the statement. Stain or paint it any color. Explore all the possible combinations at [thermatru.com/pulse](http://thermatru.com/pulse).

Wood-Grained Fiberglass:  
Mahogany or Oak (Shown in Driftwood stain.)

Smooth Fiberglass

Steel

**Note: Door and sidelite styles shown in smooth fiberglass with flat lite frame. To see styles in other material choices, go to [thermatru.com/pulse](http://thermatru.com/pulse).**

Note: See page 285 for important product details that may help with your purchase decision.

Top: Pulse Ari, Echelon Glass with Flat Lite Frame, Doors – S83EC, Finish – Canyon



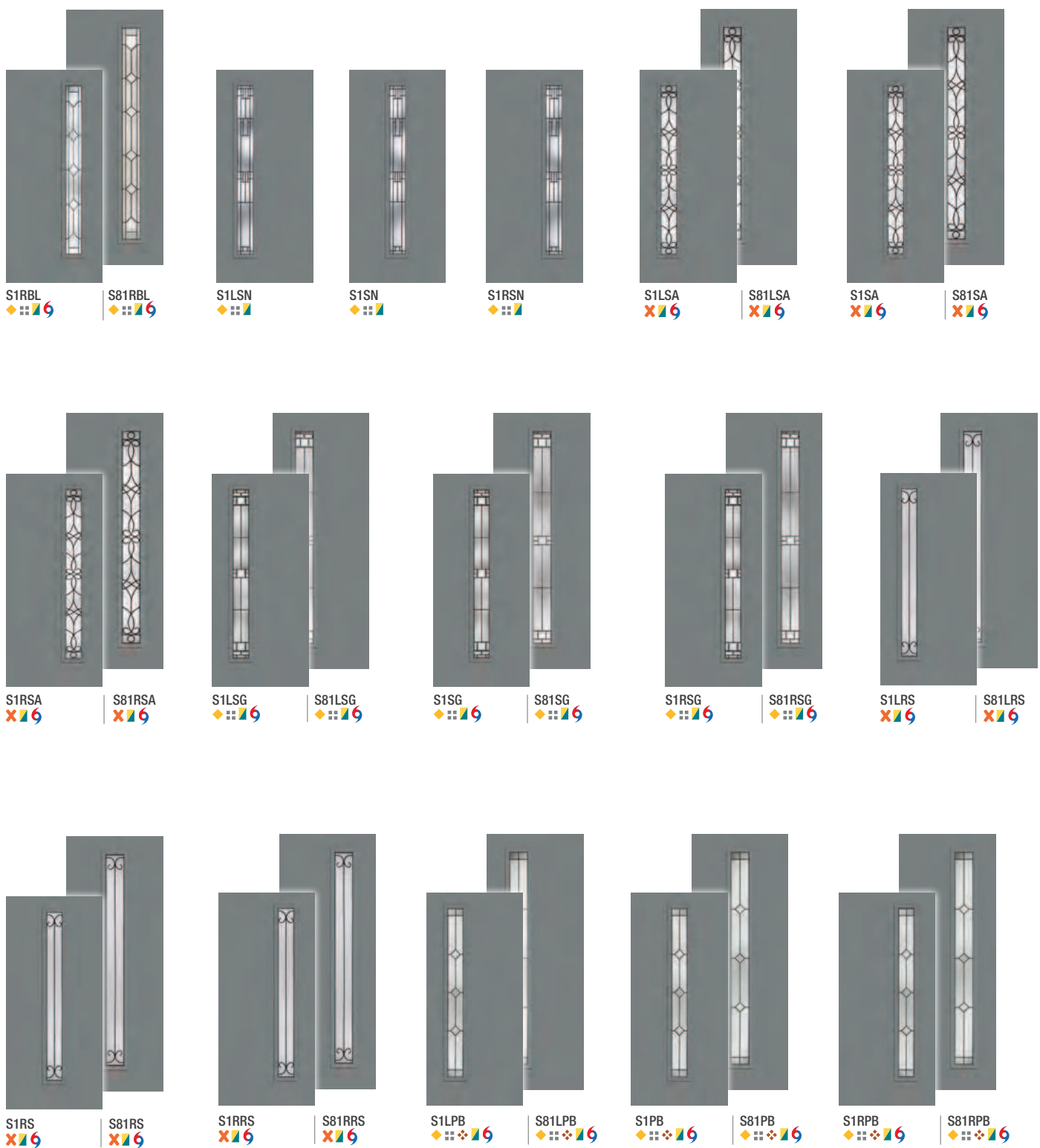

LÍNEA Continues on next page.

### Privacy & Textured Glass Options







Add the code to the blank in the style number for the desired door and glass combination. For details on glass options, see page 246.

XK = Reeded  
XE = Satin Etch

XC = Chord  
XJ = Chinchilla

XR = Rainglass  
XN = Granite

### Key

-  Low-E Glass (LE)
-  Black Nickel Caming (1D)
-  Brushed Nickel Caming (1C)
-  Brass Caming (1A)
-  Wrought Iron (1W)
-  Scrolled & Flat Advanta Lite Frame
-  WBDR / HVHZ Options

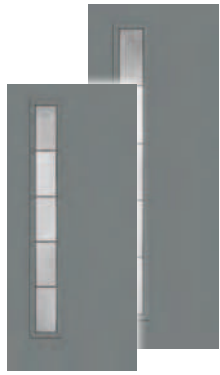

S1LAX | S81LAX



S1AX | S81AX



S1RAX | S81RAX

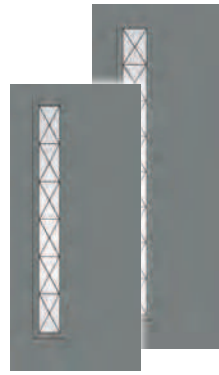

S1LCX | S81LCX

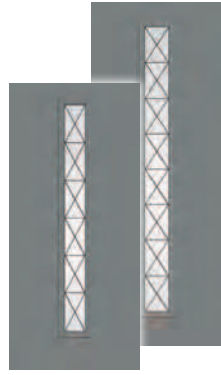

S1CX | S81CX

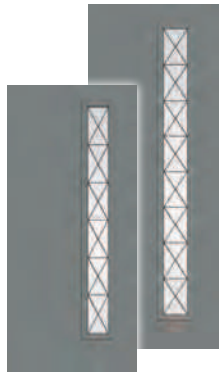

S1RCX | S81RCX

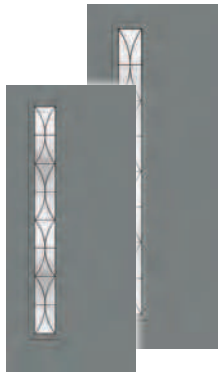

S1LLT | S81LLT

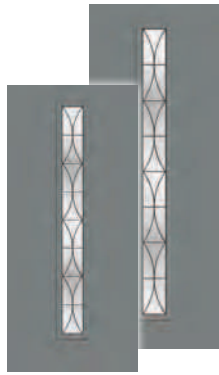

S1LT | S81LT

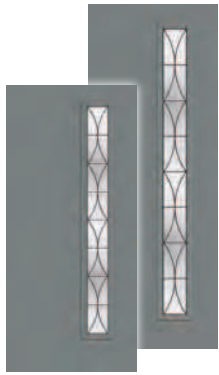

S1RLT | S81RLT



S1LEC | S81LEC

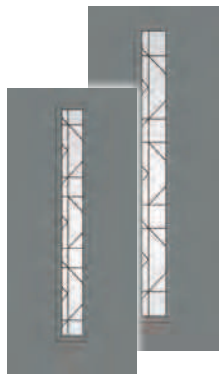

S1EC | S81EC



S1REC | S81REC

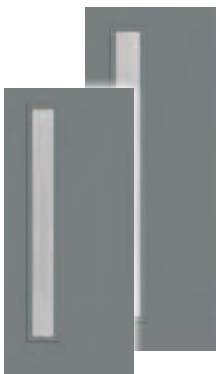

S1L | S81L

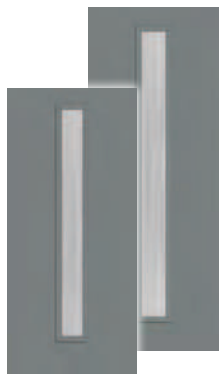

S1 | S81



S1R | S81R

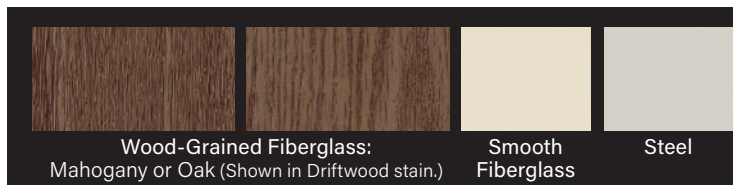

Wood-Grained Fiberglass:  
 Mahogany or Oak (Shown in Driftwood stain.)

Smooth  
 Fiberglass

Steel

**It's your decision, by design.**

Select a look for the door and sidelites. Choose a material. Find an available glass design and frame to complete the statement. Stain or paint it any color. Explore all the possible combinations at [thermatru.com/pulse](http://thermatru.com/pulse).

**Note: Door and sidelite styles shown in smooth fiberglass with flat lite frame. To see styles in other material choices, go to [thermatru.com/pulse](http://thermatru.com/pulse).**



S4LPB  
S84LPB



S4PB  
S84PB



S4RPB  
S84RPB



S5LPB  
S85LPB



S5PB  
S85PB

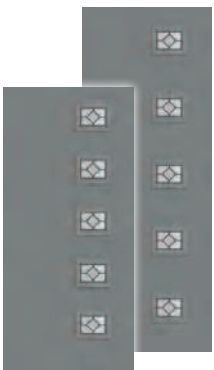

S5RPB  
S85RPB



S86LPB



S86PB



S86RPB



S9LPB



S9PB



S9RPB



S8LPB

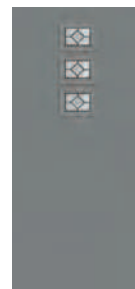

S8PB

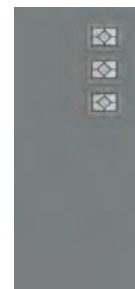

S8RPB

**ECHO** Continues on next page.

### Privacy & Textured Glass Options

Add the code to the blank in the style number for the desired door and glass combination. For details on glass options, see page 246.

XK = Reeded  
XE = Satin Etch

XC = Chord  
XJ = Chinchilla

XR = Rainglass  
XN = Granite

### Key

- Low-E Glass (LE)
- Black Nickel Caming (1D)
- Brushed Nickel Caming (1C)
- Brass Caming (1A)
- Scrolled & Flat Advanta Lite Frame
- WBDR / HVHZ Options
- Elevated 10" Bottom Rail Options



S811LPB  





S811PB  





S811RPB  

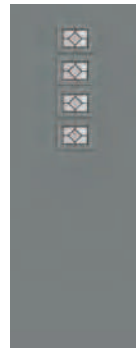

S810LPB  

S810PB  

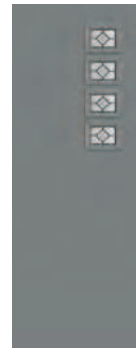
S810RPB  





S4LAX | S84LAX  

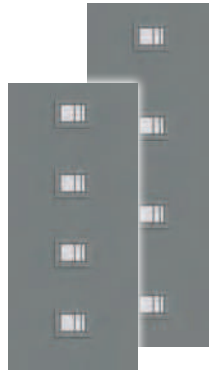

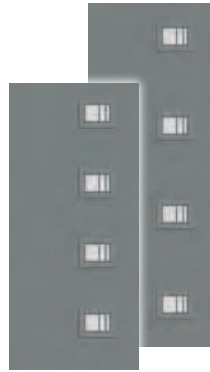

S4AX | S84AX  

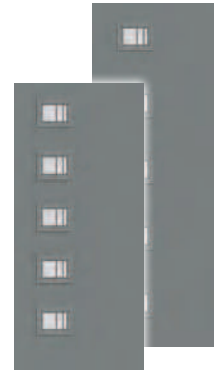
S4RAX | S84RAX  





S5LAX | S85LAX  

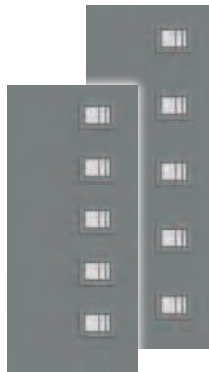

S5AX | S85AX  

S5RAX | S85RAX  



S86LAX  



S86AX  



S86RAX  

				<p><b>It's your decision, by design.</b></p> <p>Select a look for the door and sidelites. Choose a material. Find an available glass design and frame to complete the statement. Stain or paint it any color. Explore all the possible combinations at <a href="http://thermatru.com/pulse">thermatru.com/pulse</a>.</p>
<p>Wood-Grained Fiberglass: Mahogany or Oak (Shown in Driftwood stain.)</p>		<p>Smooth Fiberglass</p> <p>Steel</p>		

**Note: Door and sidelite styles shown in smooth fiberglass with flat lite frame. To see styles in other material choices, go to [thermatru.com/pulse](http://thermatru.com/pulse).**



S9LAX  
◆▲E



S9AX  
◆▲E



S9RAX  
◆▲E

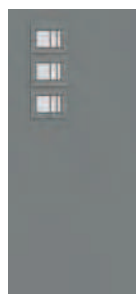

S8LAX  
◆▲E

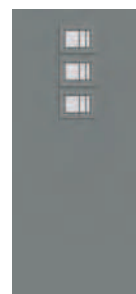

S8AX  
◆▲E

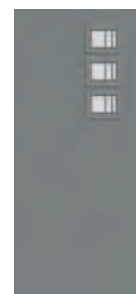

S8RAX  
◆▲E



S811LAX  
◆▲E



S811AX  
◆▲E



S811RAX  
◆▲E



S810LAX  
◆▲E

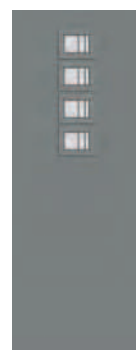

S810AX  
◆▲E



S810RAX  
◆▲E



S4L  
S4LCL ✨

S84L  
S84LCL ✨



S4  
S4CL ✨

S84  
S84CL ✨



S4R  
S4RCL ✨

S84R  
S84RCL ✨



S5L  
S5LCL ✨

S85L  
S85LCL ✨

**ECHO** Continues on next page.

### Privacy & Textured Glass Options

Add the code to the blank in the style number for the desired door and glass combination. For details on glass options, see page 246.

XK = Reeded  
XE = Satin Etch

XC = Chord  
XJ = Chinchilla

XR = Rainglass  
XN = Granite

### Key

- ✨ Low-E Glass (LE)
- ◆ Black Nickel Caming (1D)
- Brushed Nickel Caming (1C)
- ◆ Brass Caming (1A)
- ▲ Scrolled & Flat Advanta Lite Frame
- E Elevated 10" Bottom Rail Options

ECHO *Continued*



S5\_ S5CL ✨  
S85\_ S85CL ✨

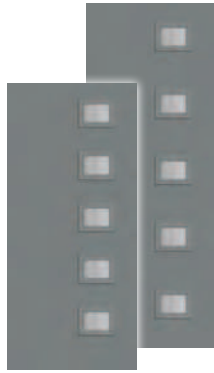

S5R\_ S5RCL ✨  
S85R\_ S85RCL ✨



S86L\_ S86LCL ✨



S86\_ S86CL ✨



S86R\_ S86RCL ✨



S9L\_ S9LCL ✨  
E



S9\_ S9CL ✨  
E



S9R\_ S9RCL ✨  
E

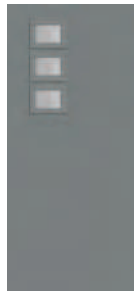

S8L\_ S8LCL ✨  
E



S8\_ S8CL ✨  
E



S8R\_ S8RCL ✨  
E



S811L\_ S811LCL ✨  
E



S811\_ S811CL ✨  
E



S811R\_ S811RCL ✨  
E



S810L\_ S810LCL ✨  
E

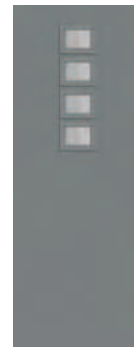

S810\_ S810CL ✨  
E

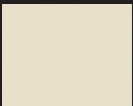

S810R\_ S810RCL ✨  
E

				<p><b>It's your decision, by design.</b></p> <p>Select a look for the door and sidelites. Choose a material. Find an available glass design and frame to complete the statement. Stain or paint it any color. Explore all the possible combinations at <a href="http://thermatru.com/pulse">thermatru.com/pulse</a>.</p>
<p>Wood-Grained Fiberglass: Mahogany or Oak (Shown in Driftwood stain.)</p>		<p>Smooth Fiberglass</p>	<p>Steel</p>	

**Note: Door and sidelite styles shown in smooth fiberglass with flat lite frame. To see styles in other material choices, go to [thermatru.com/pulse](http://thermatru.com/pulse).**

# Sidelites

Note: Product images show exterior side of door.

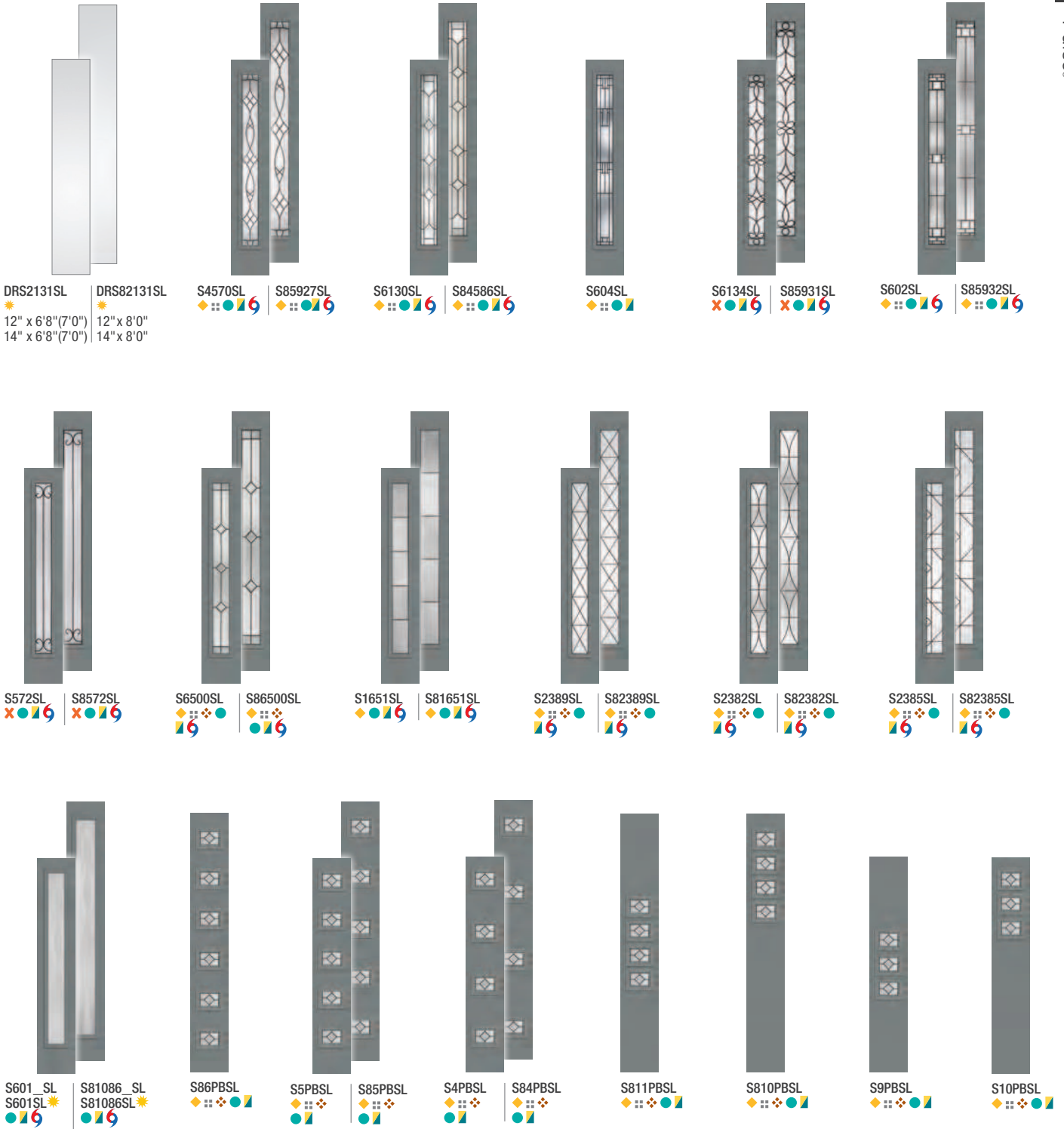

**SIDELITES** Continue on next page.

## Privacy & Textured Glass Options

Add the code to the blank in the style number for the desired door and glass combination. For details on glass options, see page 246.

XK = Reeded  
XE = Satin Etch

XC = Chord  
XJ = Chinchilla

XR = Rainglass  
XN = Granite

## Key

- Low-E Glass (LE)
- Black Nickel Caming (1D)
- Brushed Nickel Caming (1C)
- Brass Caming (1A)
- Wrought Iron (1W)
- Vented Sidelite Options
- Scrolled & Flat Advanta Lite Frame
- WBDP / HVHZ Options
- Elevated 10" Bottom Rail Options

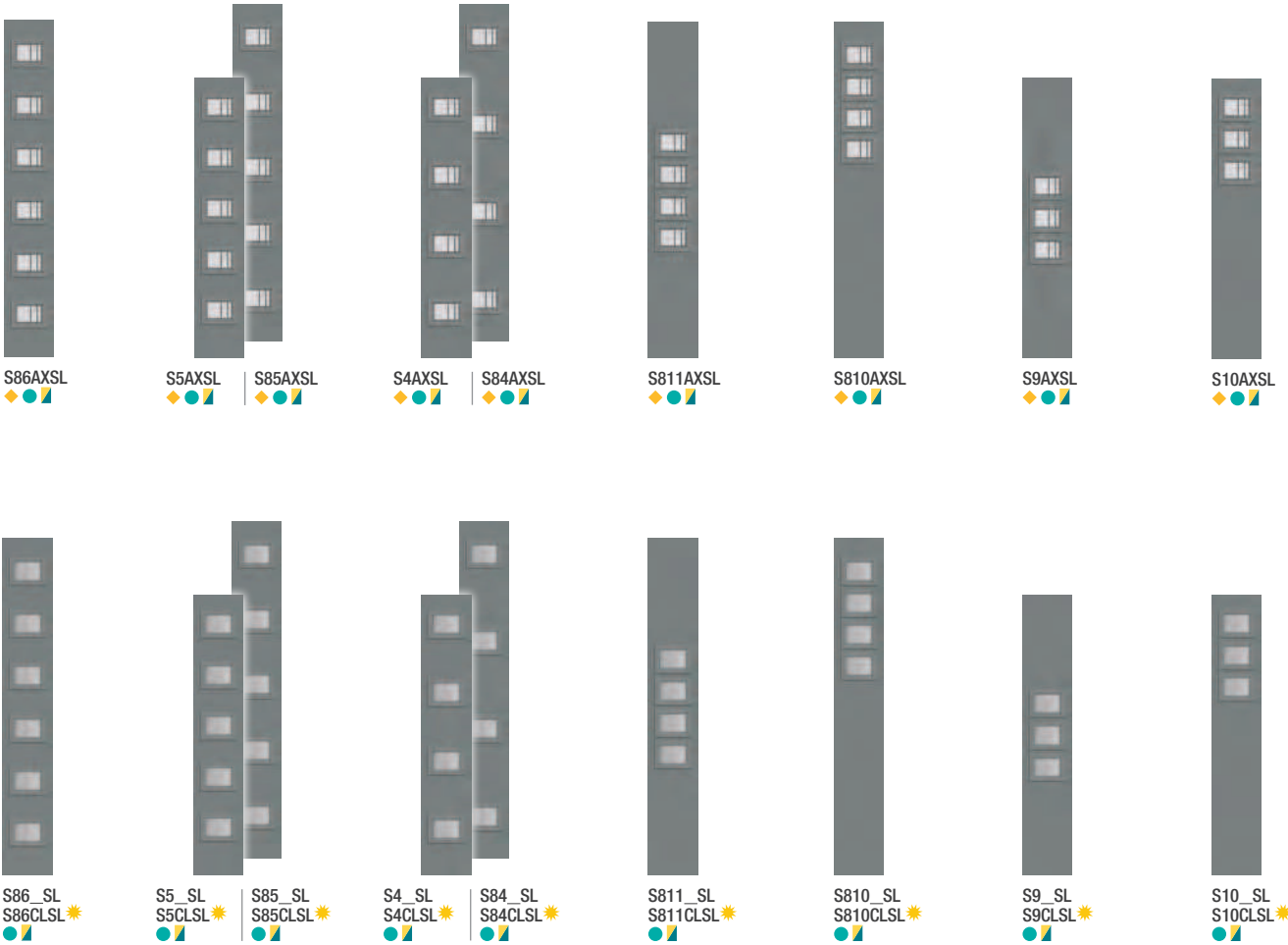

**Privacy & Textured Glass Options**

Add the code to the blank in the style number for the desired door and glass combination. For details on glass options, see page 246.

- XK = Reeded
- XE = Satin Etch
- XC = Chord
- XJ = Chinchilla
- XR = Rainglass
- XN = Granite

**Key**

-  Low-E Glass (LE)
-  Black Nickel Caming (1D)
-  Vented Sidelite Options
-  Scrolled & Flat Advanta Lite Frame



**Wood-Grained Fiberglass:**  
Mahogany or Oak (Shown in Driftwood stain.)

**Smooth Fiberglass**

**Steel**

**It's your decision, by design.**

Select a look for the door and sidelites. Choose a material. Find an available glass design and frame to complete the statement. Stain or paint it any color. Explore all the possible combinations at [thermatru.com/pulse](http://thermatru.com/pulse).

**Note: Door and sidelite styles shown in smooth fiberglass with flat lite frame. To see styles in other material choices, go to [thermatru.com/pulse](http://thermatru.com/pulse).**

Note: See page 285 for important product details that may help with your purchase decision.

Right Page, Top: Pulse Línea, Low-E Glass with Flat Lite Frame, Door – S81RCL, Direct Set Sidelite – DRS82131SL, Finish – Chestnut  
 Right Page, Bottom: Pulse Echo, Satin Etch Glass with Flat Lite Frame, Door – S85XE, Sidelite – S85XESL, Finish – Onyx





# Finishing Options

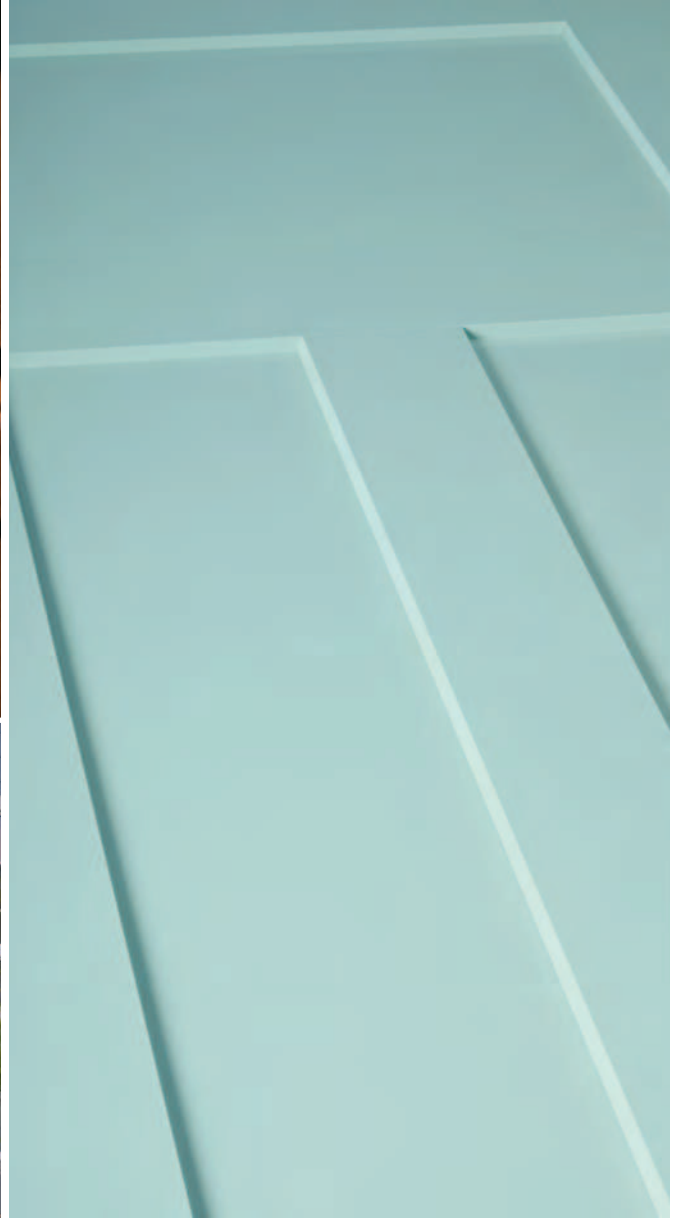

## ADD CURB APPEAL WITH COLOR

Stain and paint can make all the difference when it comes to a home's curb appeal. Find inspiration and explore professionally applied premium stains and paints, as well as options for in-field applications.

Note: Finish colors may vary from an actual application due to fluctuations in finishing or printing. See page 285 for important product details that may help with your purchase decision. See your Therma-Tru seller for details on the PrismaGuard limited warranty and exclusions.

Top: Smooth-Star, Clear Glass with SDLs, Doors - S2104, Finish - Cypress  
Right Page: Pulse Ari, Reeded Glass with Flat Lite Frame, Door - FC83XK, Finish - Acorn



## Finished for Lasting Beauty

Handcrafted and professionally applied in a controlled environment, a PrismaGuard® premium finish is built to last, giving your customers confidence and peace of mind.

- Designed for optimal performance with Therma-Tru® fiberglass doors and composite door frames.
- Features enhanced durability to protect from everyday wear and tear.
- Backed by a 10-year limited finish warranty. For Classic Craft® doors, the balance of this warranty can transfer to a second owner.
- Enhances the overall beauty of the entry with a nature-inspired color palette of premium stains and paints.



Fiber-Classic,  
Smooth-Star, Pulse  
& Steel



Durable  
Topcoat



Professional  
Application

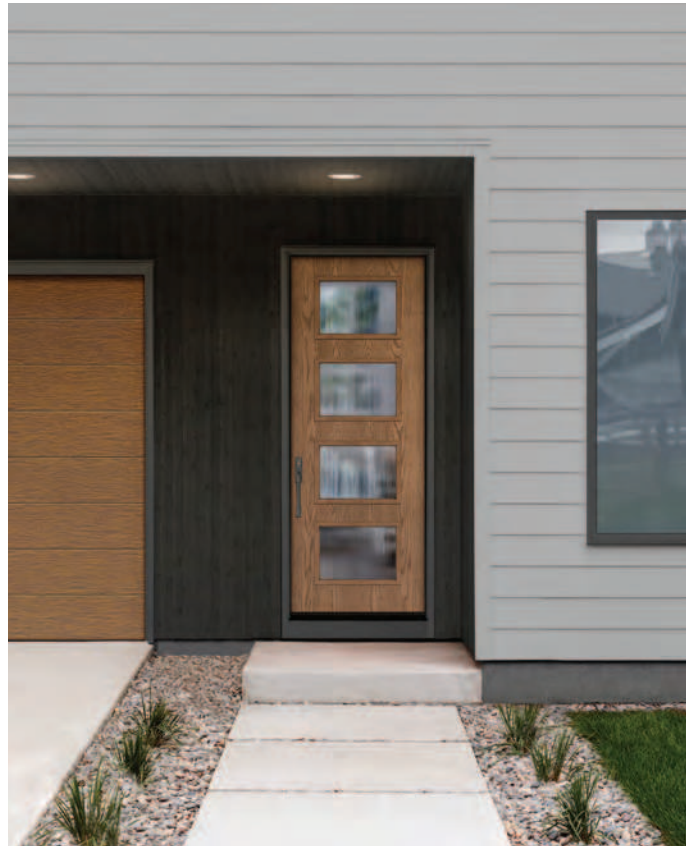

Finishing Options



Therma-Tru is proud to partner with Yellowstone Forever, the official nonprofit partner of Yellowstone National Park. Select colors in our PrismaGuard portfolio are inspired by the beauty found in Yellowstone National Park. Look for the (  ) symbol.

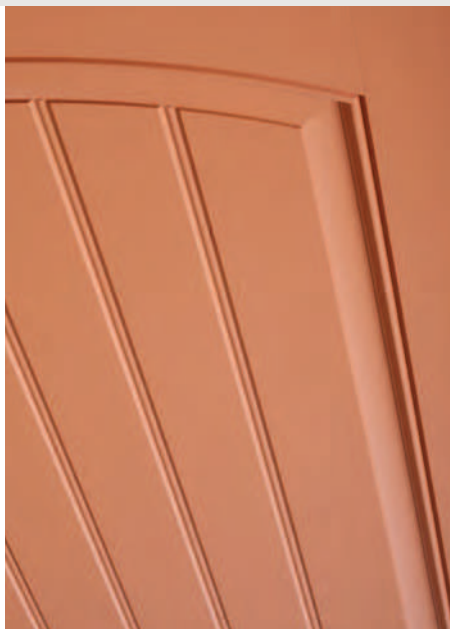



## Tested to meet tough expectations.

PrismaGuard premium finish is put through multiple rigorous tests in our engineering labs. This helps ensure that our PrismaGuard finish is built to last, just like the Therma-Tru® doors it was designed for.



### Lasting beauty and color.

Using specialized equipment, PrismaGuard stains and paints are tested to help deliver a consistent high-end appearance perfect for wood-grained or smooth door surfaces.



### Resistance against wear and tear.

PrismaGuard finish is subjected to a simulation of everyday use to provide a durable high-end, low-maintenance finish that protects the door from normal wear and tear.



### Protection from the elements.

Therma-Tru simulates exposure to harsh environments to help verify that PrismaGuard finish coating protects the door from the elements, preserving its color for years to come.



### Confidence on the coast.

Therma-Tru simulates a highly corrosive atmosphere to help ensure PrismaGuard finish can withstand the damaging effects of high-salt environments near the coast.

Note: Finish colors may vary from an actual application due to fluctuations in finishing or printing. See page 285 for important product details that may help with your purchase decision. See your Therma-Tru seller for details on the PrismaGuard limited warranty and exclusions.

# PrismaGuard® Premium Stain

Bring the authentic look of wood to life with rich tones that add dimension and are designed to enhance the wood grains of Therma-Tru® fiberglass doors and composite door frames.

- 1 It starts with the realistic wood grains and deep embossments of a Therma-Tru® door or composite door frame.
- 2 A base coat provides an even, consistent color across the surface.
- 3 A wiping stain enhances the base coat while adding dimension to reflect the natural beauty of wood.
- 4 A durable topcoat enhances the high-definition color while protecting against scratches and color fading.
- 5 A second application of the topcoat provides added durability and optimal sheen for a high-end look.

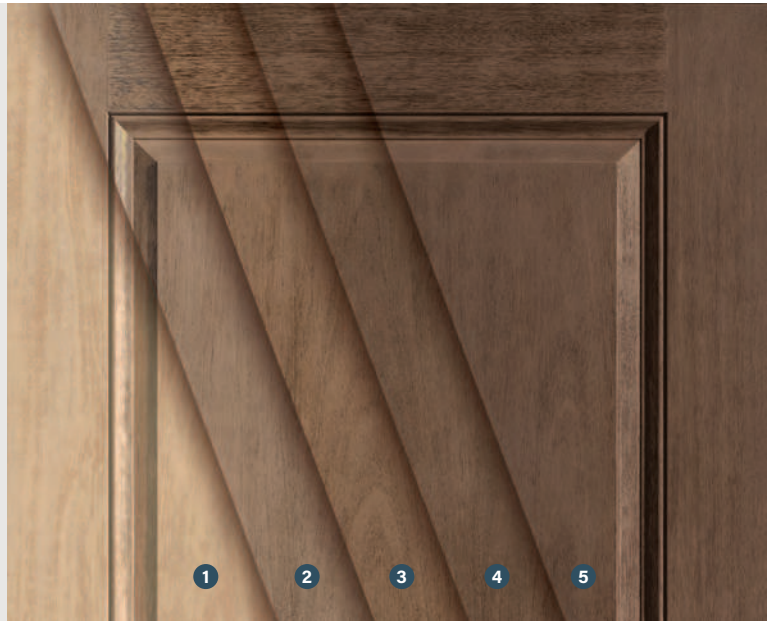

Shown on Classic Craft Fir Grain.



Order 4" x 4" samples of select PrismaGuard finish colors at [store.thermatru.com](https://store.thermatru.com).

# PrismaGuard® Premium Paint

Add a pop of color to Therma-Tru® doors and composite door frames, and tailor the look of the entry to make a beautiful lasting impression.



- 1 It starts with the smooth or wood-grained surface of a Therma-Tru door or composite door frame.
- 2 A base coat provides an even, consistent color across the surface.
- 3 A durable topcoat enhances the high-definition color while protecting against scratches and color fading.
- 4 A second application of the topcoat provides added durability and optimal sheen for a high-end look.

Bottom Left: Smooth-Star, Calix Glass, Door – S2223, Finish – Golden Wheat  
 Bottom Right: Classic Craft Fir Grain, Low-E Glass with SDLs, Door – CCA2300, Sidelites – CCA2400SL, Finish – Alpine



**COLOR MATCHES AVAILABLE.**

Explore other products from Fortune Brands Outdoors designed to match select colors shown here. Look for the (🌿) symbol. See your Therma-Tru seller for details.

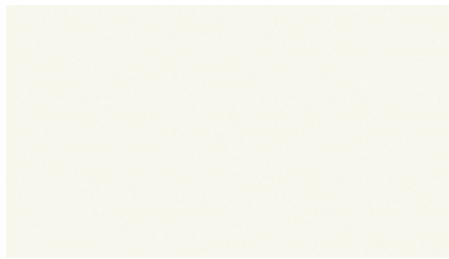

Alpine



Granite



Peregrine 🌿



Onyx

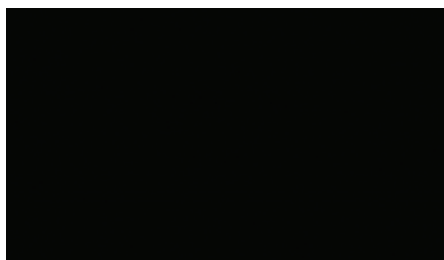

Obsidian 🌿



Indigo



Estuary 🌿



Arctic Ice 🌿



Cypress



Golden Wheat 🌿



Canyon 🌿



Ruby Red



Cabernet

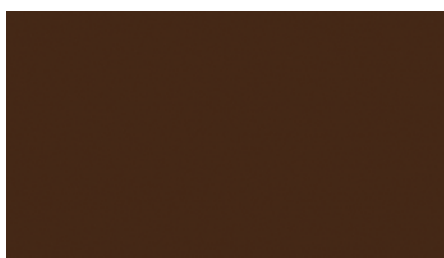

Chestnut

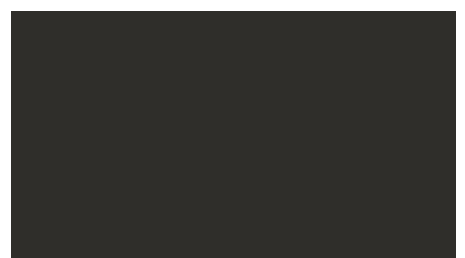

Elk 🌿

Order 4" x 4" samples of select PrismaGuard finish colors at [store.thermatru.com](https://store.thermatru.com).

# SAME-DAY<sup>®</sup> STAIN

Create the authentic look of real wood in just a few simple steps.

- Achieve professional-looking results with an easy-to-use, quick-drying formula.
- Colorfast stain resists fading, bleaching and yellowing to create a beautiful finish.
- Finish colors can be applied in a variety of shades to complement multiple home styles.
- Specially formulated for Therma-Tru<sup>®</sup> fiberglass doors and composite door frames.

Shown on  
Classic Craft Fir Grain.

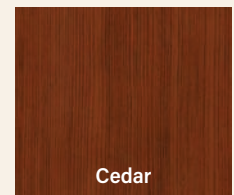
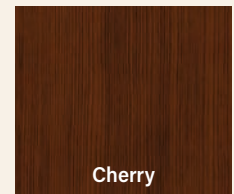
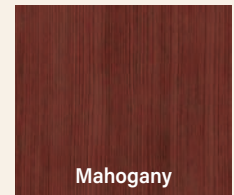
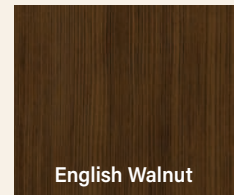
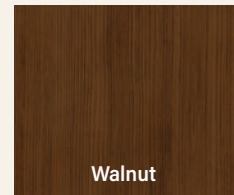
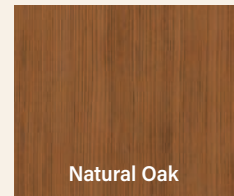
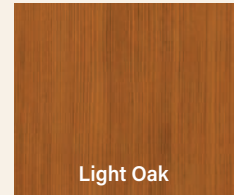

## All-Inclusive Kit

Contains everything needed to stain a Therma-Tru fiberglass double door system or a single door with two sidelites.\*

Visit [thermatru.com/samedaystain](http://thermatru.com/samedaystain) for ordering information and easy-to-follow instructions.



**5 YEAR LIMITED WARRANTY** For complete details on the Same-Day Stain and topcoat limited warranty, go to [thermatru.com/finishing](http://thermatru.com/finishing) or ask your seller for more details.

\*Actual coverage may vary based on product selected, application method and desired appearance. Note: Finish colors may vary from an actual application due to fluctuations in finishing or printing. See page 285 for important product details that may help with your purchase decision. See your Therma-Tru seller for details on the Same-Day Stain limited warranty and exclusions.



# Door System Components

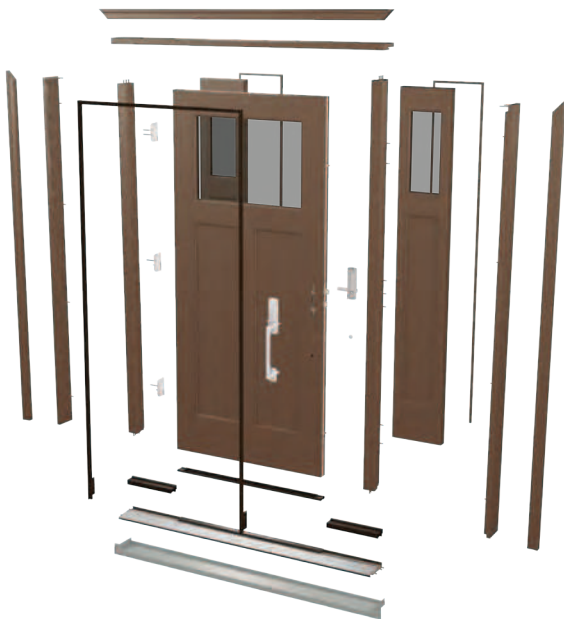

## Engineered to work together.

A Therma-Tru® door with genuine Therma-Tru components is more than a beautiful door – it's a complete door system engineered with craftsman precision for durability and reliability through the years. And, a Therma-Tru fiberglass door system with genuine Therma-Tru components is backed by the industry's most comprehensive lifetime limited warranty.

Visit our online replacement parts page to maintain the integrity of a complete door system with genuine Therma-Tru components at [thermatru.com/parts](http://thermatru.com/parts).

## Composite Door Frame\* featuring Tru-Guard™ Composite Technology



**TRU GUARD**  
COMPOSITE TECHNOLOGY

Composite door frame featuring Tru-Guard™ composite technology provides a rot-free solution engineered to work together with rot-resistant Therma-Tru® doors and components.

- Delivers extra protection from the damaging effects of outside elements for peace of mind.
- Eliminates the risk of rot and wood-ingesting insects with a durable composite material that is virtually maintenance free. Rot-free door frame does not absorb moisture and resists mold, mildew and fungus.

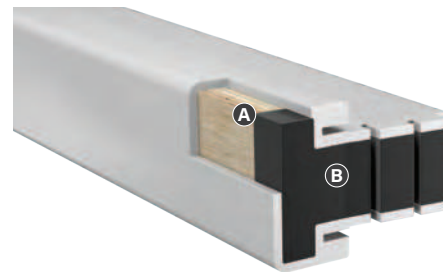

### REINFORCED MULLIONS

Provide additional structural support and stability. All mullions are reinforced with a co-extruded **A** LVL core to provide additional structural support and stability and feature a **B** composite-capped bottom to eliminate the risk of water absorption and maintain a rot-free composite exterior.

Order composite door frame samples at [store.thermatru.com](https://store.thermatru.com).

\*See your Therma-Tru seller for details on product availability.

\*\*Comparison of pendulum impact test results for Therma-Tru composite door frame and standard finger-jointed Pine wood door frame, both with similar pre-hung doors.

\*\*\*To confirm code requirements in your jurisdiction, always check with your local building code authority.

Note: See your Therma-Tru seller or visit [thermatru.com](https://thermatru.com) for details on available product sizes and options, limited warranties and exclusions, and Rider. Frame-only warranty option for customers without a Therma-Tru door system.

## AVAILABLE TEXTURES





 Ready to finish.

### Buff Grained

- Features a universal wood grain to complement a wide range of grain species.
- Stain or paint to complement the entry
  - no sanding or priming required.





 Ready to install.  
 Ready to finish.

### White Smooth

- Features a matte finish similar to painted wood and includes a protective layer with UV inhibitors to help resist yellowing and fading.
- Ready to install as-is – no painting required. Or finish with stain or paint to complement the entry – no sanding or priming required.

## THE ADVANTAGE IS CLEAR

Performance	
Resists Moisture & Humidity – Eliminates Risk of Swelling, Warping and Splitting	
Resists Mold, Fungus & Rot – Does Not Absorb or Retain Moisture	
Resists Insects – Help Protect from Wood-Ingesting Insects	
Tested to be up to 50% stronger on average than standard wood door frames against kick-ins.**	
Impact and 20-Minute Fire Code Compliant***	
Aesthetics	
Ready to Finish – No Sanding or Priming Required	
Ready-to-Install Option – No Finishing Required – White Smooth	
Universal Grain Complements a Wide Range of Wood Species – Buff Grained	
Screw Plugs Match Frame Material and Conceal External Fasteners	
Warranty	

Therma-Tru Products & Applications	Warranty For First Homeowner	Warranty Riders Transferable 1x to Second Homeowner
Composite Door Frame + Classic Craft® Door + Components		<b>Lifetime Transferable Full-System Rider</b>
Composite Door Frame + Fiber-Classic®, Smooth-Star®, Pulse® Fiberglass Door + Components		<b>10-Year Transferable Full-System Rider</b>
Composite Door Frame Only		

# Composite Door Frame Parts

See your Therma-Tru seller for a full list of available product sizes and options.

## Jambs



4-1/8"  
 4-9/16"   
 5-1/4"  
 6-9/16"   
 7-1/4"

## Mullions

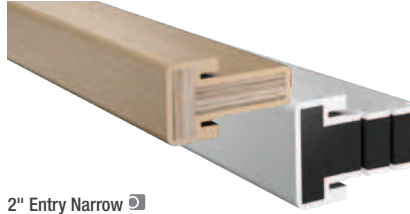

2" Entry Narrow   
 2-1/2" Entry Wide

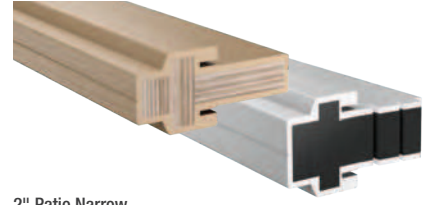

2" Patio Narrow  
 2-1/2" Patio Wide

Pre-inserted weatherstrip option available for select white smooth jambs and mullions.

## Trim

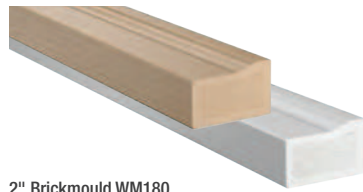

2" Brickmould WM180



1-5/8" Florida Brickmould WM176

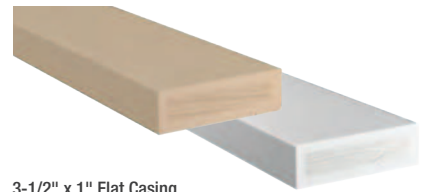

3-1/2" x 1" Flat Casing

## Mull Casing



1-15/32" x 1-1/16"



1-7/32" x 7/32"  
 2" x 7/32"



2-15/16" x 1-1/16" *Buff grained only.*  
 2-15/16" x 3/8" *Buff grained only.*

## Storm Door-Ready Mullion Adaptor



2" to 1-11/16"

## Storm Door Adaptor



4-9/16" Base Adaptor  
 Face Adaptor  
 (Use 1-15/32" x 1-1/16" Mull Casing)



6-9/16" Base Adaptor

## Screen Track Cap

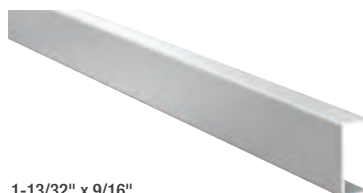

1-13/32" x 9/16"

## Fasteners, Setting Tool & Screw Plug Covers

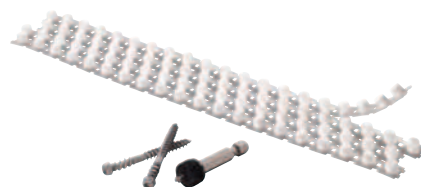

Screw plugs are available on a collated strip for ease of installation and finishing.

### Storm Door-Ready Mullions

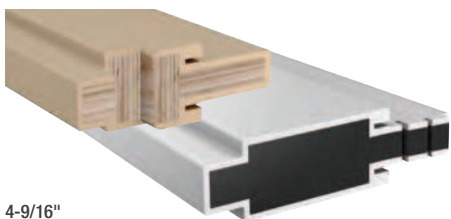

4-9/16"  
6-9/16"



7/16" x 5/16" Cove Mould

### Transom Sills



4-9/16"  
6-9/16"

Engineered as part of Therma-Tru's complete entry door system, our composite door frame is **more reliable and up to 50% stronger on average than standard wood door frames\*** when withstanding a simulated forced entry attempt by kicking in the door.\*

### Pendulum Impact Test



Therma-Tru Wood Jamb



Therma-Tru Composite Jamb

## CODE-COMPLIANT OPTIONS

Therma-Tru® composite door frame delivers the durability and reliability you expect from Therma-Tru with options to meet select national and local building code requirements.\*\*



Impact-rated to meet high-wind and coastal region codes and regulations, offering excellent performance in extreme weather conditions while providing added protection.\*\*



20-minute Fire-rated to meet most national and local code requirements for house-to-garage, multi-family residential and hotel / motel unit entries.\*\*

\*Comparison of pendulum impact test results for Therma-Tru composite door frame and standard finger-jointed Pine wood door frame, both with similar pre-hung doors.

\*\*To confirm code requirements in your jurisdiction, always check with your local building code authority.

Note: See your Therma-Tru seller or visit [thermatru.com](http://thermatru.com) for product approvals and installation instructions. Always confirm building code requirements in your area before buying. Follow weather and news reports to assess severe weather situations and obey local authorities' shelter and evacuation orders. No product guarantees safety for persons or property, nor makes any premises hurricane- or impact-proof. To see the third-party Intertek (Warnock-Hersey) listing reports, visit [thermatru.com/performance](http://thermatru.com/performance).

# Sills

Allow for a tight seal to help block wind-driven moisture infiltration at the bottom of the door and a solid stepping surface.

Available in a variety of materials with features to meet the needs of different climates and exposures. Ask your Therma-Tru® seller for a complete list of options.

## INSWING OPTIONS



**Composite Adjustable Sill (Premium)** ❖

- Thick wood-grained composite cap and nosing.
- U-shaped weather seal.
- Adjustable flush screws.
- Solid extruded composite substrate.

Continuous length with spread mullion capability to fill 49"-75" rough openings.\*

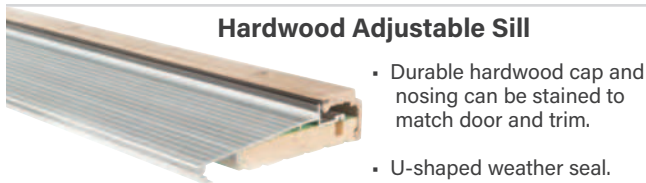

**Hardwood Adjustable Sill**

- Durable hardwood cap and nosing can be stained to match door and trim.
- U-shaped weather seal.
- Adjustable flush screws.



**Basic Composite Adjustable Sill (Economy)**

- Wood-grained composite cap and nosing.
- Adjustable screws with removable screw caps.

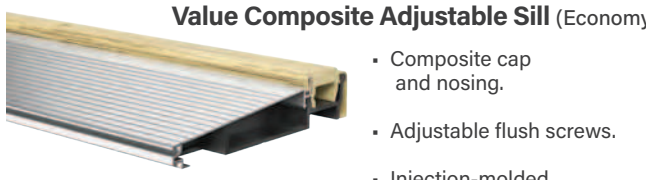

**Value Composite Adjustable Sill (Economy)**

- Composite cap and nosing.
- Adjustable flush screws.
- Injection-molded composite substrate.

## Inswing Sill Extenders

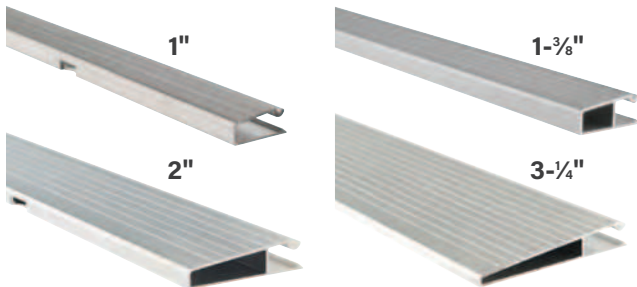

## OUTSWING OPTIONS



**Composite Outswing Sill (Premium)** ❖

- Thick wood-grained composite cap and nosing.
- Integrated weatherstrip.
- Helps meet code requirements in HVHZ coastal regions.



**Aluminum Sill with Thermal Break**

- All-aluminum construction.
- Integrated weatherstrip.
- Also available without thermal break.



**Coastal Sill (For Coastal Regions)**

- All-aluminum construction.
- Extra-high cap profile.
- Integrated weatherstrip.
- Helps meet code requirements in HVHZ coastal regions.

## Public Access Sill



**Public Access Sill with Thermal Break\*\***

- (For ADA Applications)
- All-aluminum construction.
  - Ramp slope meets Americans with Disabilities Act (ADA) requirements.
  - Also available without thermal break.

\*See the Therma-Tru Architectural Details & Components manual for actual unit size specifications.

\*\*Door systems built with public access sills have little resistance to water penetration and have a potential to leak if installed exposed to weather. We recommend these systems be installed away from weather under large soffits or overhangs.

\*\*\*For full details on the Tru-Defense Warranty Rider, visit [thermatru.com/trudefense](http://thermatru.com/trudefense).

Note: Finish colors may vary from an actual application due to fluctuations in finishing or printing. See page 285 for important product details that may help with your purchase decision.

## Key



**SILL FINISHES**



Mill



Bronze

**CAP COLORS**



Lightwood (Premium)



Darkwood (Premium)



Lightwood (Economy)



Darkwood (Economy)



Hardwood

■ = Available  
 · = Not Applicable

	Inswing Options			Outswing Options				Public Access (Inswing / Outswing)	
	Composite Adjustable (Premium)	Hardwood Adjustable	Value Composite Adjustable (Economy)	Composite Outswing (Premium)	Aluminum with Thermal Break	Aluminum without Thermal Break	Coastal	Public Access (Inswing / Outswing)	Public Access (ADA)**
<b>Sill Finishes</b>									
Mill	■	■	■	■	■	■	■		■
Bronze	■	■	■	■	■	■	·		■
<b>Cap Colors</b>									
Lightwood	■	·	■	■	·	·	·		·
Darkwood	■	·	■	■	·	·	·		·
Hardwood	·	■	·	·	·	·	·		·
<b>Sill Configurations</b>									
Single	■	■	■	■	■	■	■		■
French	■	■	·	■	■	■	■		■
Double Patio	■	■	·	■	·	·	·		·
Triple Patio	■	·	·	■	·	·	·		·
Lineal	■	■	·	·	·	·	·		·
<b>Sidelite Configurations</b>									
Boxed Sidelites	■	·	·	·	·	·	·		·
Single with Sidelites	■	■	·	■	·	·	·		·
French with Sidelites	■	·	·	·	·	·	·		·
Single Vented Sidelites	■	·	·	·	·	·	·		·
French Vented Sidelites	■	·	·	·	·	·	·		·
<b>Depths</b>									
4-9/16"	■	·	■	■	·	■	■		■
5-3/4"	■	■	■	■	■	·	·		·
6-9/16"	·	·	·	·	·	·	·		■
7-3/4"	■	■	■	·	■	·	·		·
<b>Substrates</b>									
Composite Extruded	■	·	·	■	·	·	·		·
Composite Injection Molded	■	·	■	·	·	·	·		·
Treated Pine	·	■	·	·	■	■	■		·
<b>Other Options</b>									
Integrated Thermal Break	■	■	■	■	■	·	·		■
Screen Rail Available	■	■	·	·	·	·	·		·
Sill Extenders Available	■	■	■	■	·	·	·		·
Sill Covers Available	■	■	■	■	·	·	·		·
Tru-Defense Eligible***	■	·	·	■	·	·	·		·
With Anchor Holes	·	·	·	·	■	■	■		■
Without Anchor Holes	■	■	■	■	■	·	·		·

Note: See your Therma-Tru seller for details on available component and finish color combinations.

# Door Bottoms

Designed to mate with our sills and help provide added protection to help seal the margin between the door and sill. Kerf-applied for a secure fit and made of a heavy-duty material that holds its shape to help maintain contact.

## INSWING OPTIONS



**Kerf-Applied Dual-Bulb / Dual-Fin Bottom Sweep** ✚

**Sills:**  
Composite Adjustable  
Hardwood Adjustable  
Value Composite Adjustable

**Colors:**  
Bronze  
White



Non-kerf-applied option available for replacement applications. Available in bronze only.

## OUTSWING OPTIONS

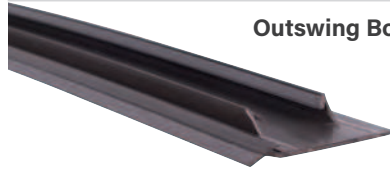

**Outswing Bottom Sweep**

**Sills:**  
Aluminum  
Coastal

**Color:**  
Bronze



**Inactive Door Bottom**

**Sills:**  
Composite Outswing

**Colors:**  
Bronze



**Inactive Door Bottom** ✚

**Sills:**  
Composite Adjustable  
Hardwood Adjustable

**Colors:**  
Bronze

## ADA / REPLACEMENT



**Bottom Sweep**

**Sills:**  
Public Access

**Color:**  
Bronze

# Sill Protection



**Sill Covers (Recommended)**

- Fits over the sill to help protect cap and finish from damage during installation.
- Made of a heavy-duty material to withstand wear.
- Available in a variety of options to fit our sills.

Shown over composite adjustable sill.

See page 271 for availability.



**Sill Pan (Recommended)** ✚

- Fits between the sill and subfloor for an added layer of protection against moisture.
- Engineered with sloped channels to help collect and drain moisture away.



## Corner Seal Pads (Inswing Only)

Fit securely behind weatherstrip and mate with our inswing sills to help block wind-driven moisture from pushing through the corner and up the frame. (Not required for outswing sills.)

### Classic Craft® 7-Shape Pads



**Colors:**  
Bronze  
White

**Sills:**  
Composite Adjustable  
Hardwood Adjustable  
Value Composite Adjustable  
Public Access

### Fiber-Classic® / Smooth-Star® 7-Shape Pads



**Colors:**  
Bronze  
White

**Sills:**  
Composite Adjustable  
Hardwood Adjustable  
Value Composite Adjustable  
Public Access

### Basic Pads

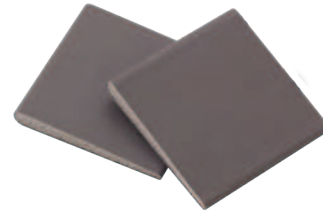

**Colors:**  
Bronze

**Sills:**  
Inswing  
Applications Only

## Weatherstrip

Engineered in a variety of profiles for a precise seal between the door and frame. Made of a flexible material protected by a durable jacket to resist moisture and wear.

### Medium-Reach Weatherstrip



**Colors:**  
Bronze  
White

### Long-Reach Weatherstrip



**Colors:**  
Bronze  
White

## Rain Protection (Recommended)

Helps repel moisture away from areas exposed to wind-driven moisture infiltration, enhancing weather protection. Highly recommended for applications directly exposed to wind and rain.

### Rain Deflector (Inswing)



**Colors:**  
Bronze  
White

### Rain Guard (Outswing)



**Colors:**  
Bronze  
White

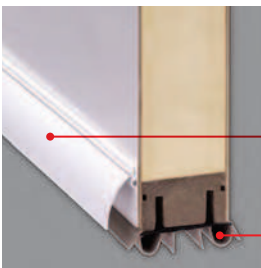

Rain Deflector

Bottom Sweep

Bottom of door; exterior view.



Jamb

Rain Guard

Weatherstrip

Top of door; exterior view.

### Key

 Tru-Defense Eligible

# Hardware

## Multi-Point Locking Systems (MPLS) (Recommended)

Engages the door and frame at three critical points from top to bottom for enhanced stability compared to traditional deadbolt assemblies. Features premium stainless steel construction that resists corrosion.

### GRIP-STYLE MPLS

Grip-style handlesets offer an intuitive approach to the multi-point locking system with on-trend aesthetics. A simple 90-degree twist of the thumbturn (interior) or a key (exterior) is all it takes to engage the door frame at three points with no need to lift the handleset lever. An integrated mishandling device protects the door and frame from accidental damage. Features deadbolt located above handleset.

(Highly recommended for 8'0" fiberglass doors. Active option only. Not available for door systems with an astragal. Not recommended for steel doors or Impressions integrated storm and entry door systems. Strike plate package available.)

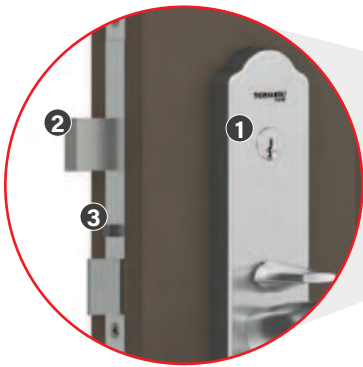

**Tongue**  
 Heights: | Configurations:  
 6'8" | Inswing  
 7'0" | Outswing  
 8'0"

- ① Self-lubricating locks.
- ② 1" premium stainless steel deadbolt.
- ③ Integrated mishandling device.

### Key

Tru-Defense Eligible



## LEVER-STYLE MPLS +

Lever-style handlesets bring form and function together with decorative styles. A convenient upward turn of the handle is required before all three points will engage. An integrated mishandling device helps protect the door and frame from accidental damage. Features deadbolt below the handleset.

(Highly recommended for 8'0" and double fiberglass doors. Not recommended for steel doors. Strike plate packages available to meet the installation needs of various MPLS applications.)



Side view of door.

Engages at three critical points.

Exterior view of door.



### Tongue

<b>Heights:</b>	<b>Configurations:</b>
6'6"	Inswing
6'8"	Outswing
7'0"	
8'0"	



### Shootbolt

(For door systems with an astragal.)

<b>Heights:</b>	<b>Configurations:</b>
6'6"	Inswing
6'8"	Outswing
7'0"	
8'0"	



## Vented Sidelite MPLS



### Tongue

(Included in vented sidelite units.)

**Heights:**  
6'6"  
6'8"  
8'0"

## Handleset Options for Standard Door MPLS

Designed to complement Therma-Tru® door styles from traditional to contemporary.

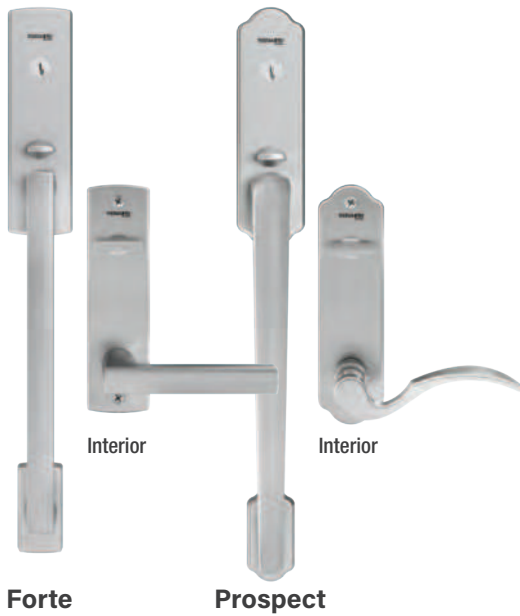

### FINISH OPTIONS

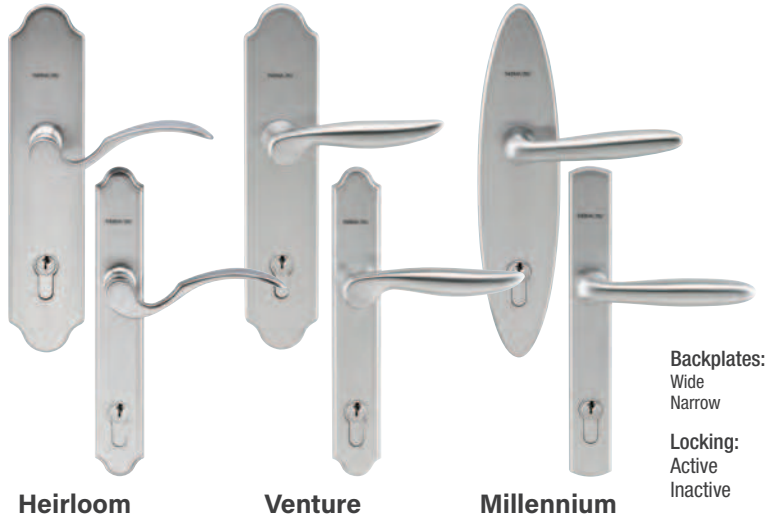
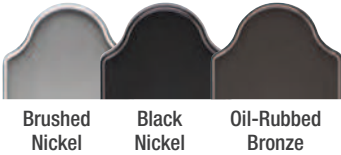

### FINISH OPTIONS

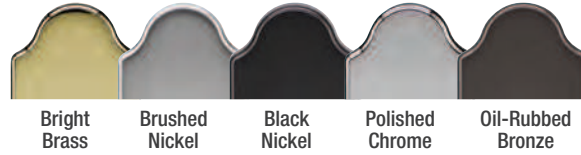

## Latch & Deadbolt Strike Plate



Standard vs. Adjustable Security Strike Plate

### ADJUSTABLE SECURITY STRIKE PLATE

(Recommended for standard lock and deadbolt handlesets only.)

#### Finish Options:

- Brushed Nickel
- Black Nickel
- Polished Chrome
- Oil-Rubbed Bronze
- Stainless Steel
- Zinc Dichomate

A genuine Therma-Tru® adjustable security strike plate helps enhance the safety and security of a home, wrapping around the door jamb and fully engaging the frame of the house for added support and strength against forced entry.

- 1** Wraps around the door jamb for added support and an exact fit.
- 2** 2-1/2" screws fully engage with the frame of the house for added strength.

\*To confirm code requirements in your jurisdiction, always check with your local building authority.  
Note: See your Therma-Tru seller for available component options.

# Hinges

## Adjustable Hinge

(Recommended for Classic Craft premium entryways.)

Allow the door to be moved horizontally and vertically in the frame, maintaining alignment and keeping the door performing beautifully.



## Self-Aligning Ball-Bearing

(Recommended for heavier Fiber-Classic, Smooth-Star and Steel doors.)

Contains locating tabs to assist in accurate alignment with specific door systems.

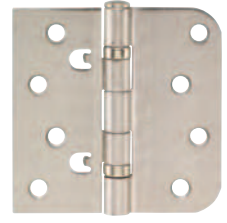

## Classic-Craft® Ball-Bearing

(Recommended for Classic Craft premium entryways.)

Ball bearings help protect each hinge pivot for added support and stability.

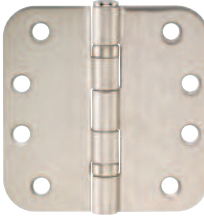

## Self-Aligning

(Recommended for heavier Fiber-Classic, Smooth-Star and Steel doors.)

Contains locating tabs to provide accurate alignment with specific door systems. Note: Non-removable pin option available with fixed pins, providing security on outswing applications.



## Classic-Craft® Ball-Bearing - Staggered Hole Pattern

(Recommended for Classic Craft premium entryways.)

Ball bearings help protect each hinge pivot for added support and stability. Staggered hole pattern helps simplify assembly process. Note: Non-removable pin option available with fixed pins, providing security on outswing applications.



## Security Tab

Security tabs prevent door from being taken off hinges, providing security on outswing applications.



## Spring-Loaded

UL Listed with self-closing spring mechanism that helps pull the door closed for convenience or meets code requirements that may be applicable in Fire-door applications.\*



## HINGE FINISH OPTIONS



Bright Brass    Brushed Nickel    Black Nickel    Polished Chrome    Oil-Rubbed Bronze    Stainless Steel    Zinc Dichromate

Hinge Finish Options	■ = Available - = Not Applicable									
	Adjustable	Classic Craft Ball-Bearing	Classic Craft Ball-Bearing - Staggered Hole Pattern	Classic Craft Ball-Bearing - Staggered Hole Pattern (Non-Removable Pin)	Self-Aligning Ball-Bearing	Self-Aligning	Self-Aligning NRP (Non-Removable Pin)	Security Tab	Spring-Loaded	
Bright Brass	■	■	■	■	■	-	-	-	-	
Brushed Nickel	■	■	■	■	■	■	■	■	■	
Black Nickel	■	■	■	■	■	-	■	-	■	
Polished Chrome	■	■	■	■	■	-	■	-	■	
Oil-Rubbed Bronze	■	■	■	■	■	■	■	-	■	
Stainless Steel	-	■	■	■	■	-	■	■	■	
Zinc Dichromate	-	■	■	■	■	■	■	■	■	

Hinges position the door to properly compress the weatherstrip and help ensure smooth operation. Features options to suit various applications and mate with mortise pockets machined into our doors. Adjustable security strike plate wraps around the jamb and engages the frame for added support and strength, and resistance against forced entry.

# Astragals

Cover the margin between double doors to help complete the seal against air and moisture infiltration, with aluminum construction for stability, holding power and durability. Available in a stainable wood-grained vinyl wrap or aluminum.



## STAINABLE ASTRAGAL



- Heights:**  
6'6"  
6'8"  
7'0"  
8'0"
- Width:**  
7/8"
- Configurations:**  
Inswing  
Outswing  
Multi-Point Lock  
Double Bore  
Left-Handed  
Right-Handed
- Grain Options:**  
Oak  
Fir
- Weatherstrip:**  
Bronze

Shown in Oak grain with Driftwood stain.

## ALUMINUM ASTRAGAL



- Heights:**  
6'6"  
6'8"  
7'0"  
8'0"
- Width:**  
7/8"
- Configurations:**  
Inswing  
Outswing  
Multi-Point Lock  
Double Bore  
Left-Handed  
Right-Handed
- Finish Colors:**  
Bronze  
White
- Weatherstrip:**  
Bronze

Coastal option also available.

Available with strike plates to receive a latch and deadbolt or multi-point locking system.

Integrated weatherstrip and corner seal pad helps form a tight seal between the astragal and active door when closed.

Spring clips to engage and disengage the shootbolts.

Durable boot engineered to work with the active bottom sweep to complete the seal across the sill.

16-1/2" locking steel slide bolt can be vertically adjusted for a secure fit with the sill and frame.

## TEXTURES AVAILABLE

Stainable (Shown in Driftwood stain.)



Oak Grain

Fir Grain

Aluminum



Bronze

White

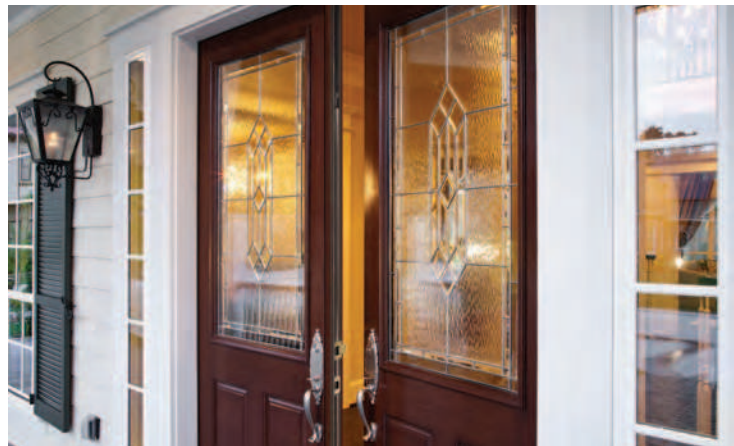

Note: Finish colors may vary from an actual application due to fluctuations in finishing or printing. See page 285 for important product details that may help with your purchase decision.

Bottom: Classic Craft Mahogany Grain, Provincial Glass, Doors - CCR804028

Right Page, Top: Fiber-Classic Oak Collection, Clear Glass with GBGs, Doors - 8000-12, Finish - Raven

Right Page, Bottom Left: Classic Craft Fir Grain, Homeward Glass, Doors - CCA211, Finish - Driftwood

Right Page, Bottom Right: Fiber-Classic Oak Collection, Clear Glass with GBGs, Doors - FC8313, Finish - Barley

## Key

 Tru-Defense Eligible



# Special Quote Program

In addition to thousands of standard glass choices, we offer additional glass options through our Special Quote Program to help you find the right look for virtually any home.



Special Quote SDL Pattern Example

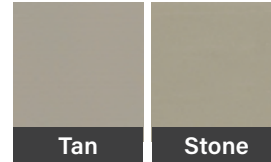

Special Quote  
GBG Color Options

## DIVIDED LITES

Match various window patterns and home styles with additional grid patterns and color options. Impact-rated options also available.



## PRIVACY & TEXTURED GLASS

Achieve the desired look and level of privacy with additional options, including hammered glass doorlites shown above.

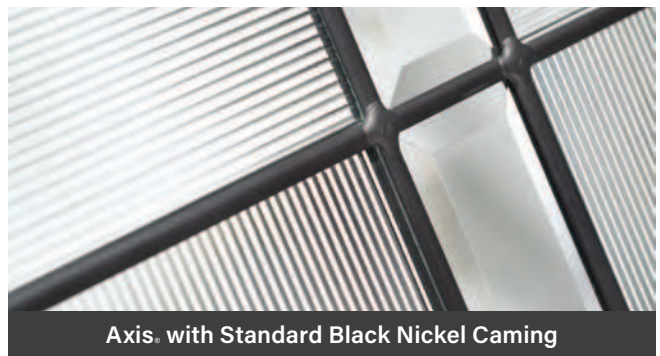

Axis. with Standard Black Nickel Caming

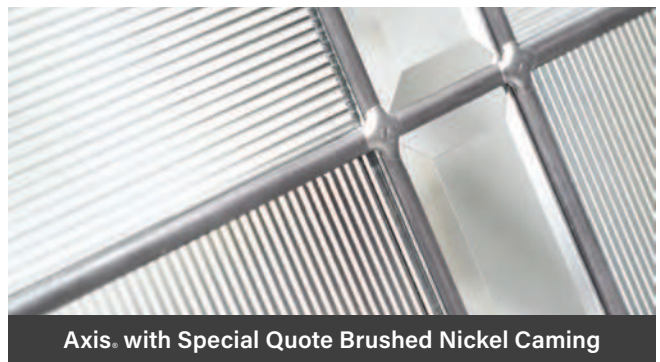

Axis. with Special Quote Brushed Nickel Caming

## CAMING COLORS

Pair black nickel, brushed nickel or brass caming with any decorative glass design to complement home hardware and fixtures.



# 3'6" Width Door Style Options

## CLASSIC CRAFT.

8'0" Door Styles



Glass Designs

Homeward™	■		■			■	■
Arborwatch™	■		■			■	■
Augustine.	◆	◆	◆	◆	◆	◆	
Borrassa.	◆	◆	◆	◆	◆	◆	
Lucerna.	◆		◆			◆	
Rainglass							■
Low-E	◆		■			◆	■

### Key

- Classic Craft. Artissa Collection™
- ◆ Classic Craft. Founders Collection™
- ▲ Classic Craft. Visionary Collection™
- \* Smooth-Star.
- ▮ Profiles™ & Traditions

## 6'8" & 8'0" Solid-Panel Door Styles

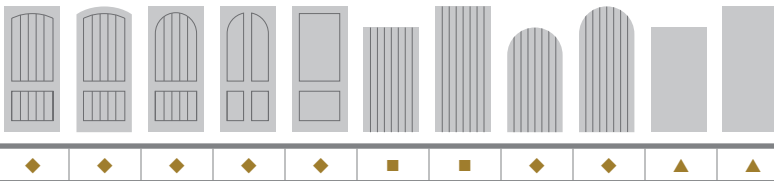

## SMOOTH-STAR®, PROFILES™, TRADITIONS & PULSE.

6'8" & 8'0" Door Styles



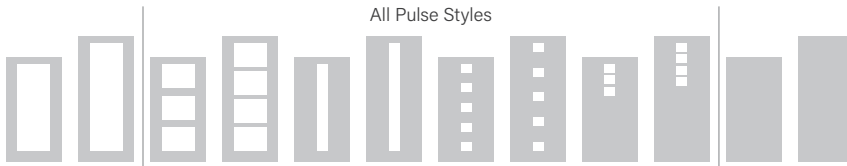







All Pulse Styles



Glass Designs

Blackstone.	* ▮	*			* ▮	*						
Crystalline™	* ▮	*			* ▮	*						
Sedona	* ▮		* ▮	*	* ▮	*						
Salinas.	* ▮	*			* ▮	*						
Maple Park.	* ▮											
Saratoga™	* ▮		* ▮	*	* ▮	*						
Texas Star	* ▮											
Wellesley™	* ▮	*										
Riserva.	* ▮	*	* ▮	*	* ▮	*						
Concorde™	* ▮	*										
Kensington™	* ▮											
Pembridge™	* ▮	*	* ▮	*	* ▮	*	* ▮	*	* ▮	*		
Axis.	* ▮	*	* ▮	*	* ▮	*	* ▮	*	* ▮	*		
Calix	* ▮	*	* ▮	*	* ▮	*						
Latitude	* ▮	*			* ▮	*						
Echelon	* ▮	*	* ▮	*	* ▮	*						
Privacy & Textured Glass	* ▮	*	* ▮	*	* ▮	*	* ▮	*	* ▮	*		
Internal Blinds	* ▮	*										
Divided Lites	* ▮	*										
Clear	* ▮	*	* ▮	*	* ▮	*	* ▮	*	* ▮	*		
Solid Panel											* ▮	*

# 7'0" Height Door Style Options

Glass Designs	Door Styles											
												
Blackstone <sub>®</sub>	▼▲**	▲**	*		▶							
Crystalline <sub>™</sub>	▼▲**				▶							
Sedona	▼▲**	▲**	*		▶							
Salinas <sub>®</sub>	▼▲**	▲**	*		▶							
Maple Park <sub>®</sub>	▼▲**	▲**	*		▶			▲**				
Saratoga <sub>™</sub>	▼▲**	▲**	*		▶		▼*	▲**				
Texas Star	▼▲**	▲**	*		▶							
Wellesley <sub>™</sub>	▼▲**	▲**	*		▶			▲**				
Riserva <sub>®</sub>	▼▲**	▲**	*		▶							
Concorde <sub>™</sub>	▼▲**	▲**	*		▶			▲**	▶			
Kensington <sub>™</sub>	▼▲**	▲**	*		▶							
Pembridge <sub>™</sub>	▼▲**	▲**	*		▶			▶		▲▶		
Axis <sub>®</sub>	▼▲**	▲**	*		▶					▲**		
Calix	▼▲**	▲**	*									
Latitude	▼▲**											
Echelon	▼▲**											
Privacy & Textured Glass	▼▲**	▲**	*	▼▲**	▶		▼*			▲**		
Internal Blinds	▼▲**	▲**	*	▼▲**								
Screen Vented		*▶	*	*▶								
Divided Lites	▼▲**	▲**	*		▶	*▶	▼*	▲**	▶		▶	
Clear	▼▲**	▲**	*	▼▲**	▶	*▶	▼*	▲**	▶	▲**		
Solid Panel												▲**▶

# 6'6" Height Door Style Options

Glass Designs	Door Styles		
			
Blackstone <sub>®</sub>	▲**	▲**	
Crystalline <sub>™</sub>	▲**	▲**	
Sedona	▲**	▲**	
Salinas <sub>®</sub>	▲**	▲**	
Maple Park <sub>®</sub>	▲**	▲**	
Saratoga <sub>™</sub>	▲**	▲**	
Texas Star	▲**	▲**	
Wellesley <sub>™</sub>	▲**	▲**	
Riserva <sub>®</sub>	▲**	▲**	
Concorde <sub>™</sub>	▲**	▲**	
Kensington <sub>™</sub>	▲**	▲**	
Pembridge <sub>™</sub>	▲**	▲**	
Axis <sub>®</sub>	▲**	▲**	
Calix	▲**	▲**	
Latitude	▲**	▲**	
Echelon	▲**	▲**	
Privacy & Textured Glass	▲**	▲**	
Internal Blinds	▲**	▲**	
Screen Vented			
Divided Lites	▲**	▲**	
Clear	▲**	▲**	
Solid Panel			▲**▶

### Key

- ▲ Classic Craft<sub>®</sub>  
Visionary Collection<sub>™</sub>
- ▼ Fiber-Classic<sub>®</sub> Mahogany Collection<sub>™</sub>
- ▲ Fiber-Classic<sub>®</sub> Oak Collection<sub>™</sub>
- \* Smooth-Star<sub>®</sub>
- ▶ Profiles<sub>™</sub> & Traditions

		▼▲*▷	▷					
		▼▲*▷						
		▼▲*▷	▷					
		▼▲*▷	▷					
		▼▲*▷	▷					
		▼▲*▷	▷	▼*				
		▼▲*▷	▷					
		▼▲*▷	▷					
		▼▲*▷	▷					
		▼▲*▷	▷					
		▼▲*▷	▷			▷		
		▼▲*▷	▷			▷		
		▼▲*▷						
		▼▲*▷						
		▼▲*▷						
		▼▲*▷	▷	▼*		▷		
		▼▲*▷	▷					
	▷	▼▲*▷	▷	▼*				
		▼▲*▷	▷	▼*		▷		
						*	▲*▷	▲▼▲*▷



Top: Smooth-Star, Maple Park Glass, Door – S6107  
 Bottom: Smooth-Star Door – S210; Clear Glass with GBGs, Sidelites – S308SL

# Entry & Patio Door Systems

Feature	Classic Craft	Fiber-Classic. & Pulse. Wood-Grained	Smooth-Star. & Pulse. Smooth	Profiles. & Pulse. Steel (6'8")	Traditions & Pulse. Steel (8'0")
<b>Skin Material</b>	Fiberglass	Fiberglass	Fiberglass	24-Gauge Steel	6'8": 25-Gauge Steel / 8'0": 24-Gauge Steel
<b>Skin Texture</b>	Fir, Walnut, Mahogany; High-Detail Smooth	Mahogany, Oak Grain	High-Detail Smooth	Smooth	Smooth
<b>Exterior Finish</b>	Stain or Paint	Stain or Paint	Paint	Paint	Paint
<b>Interior Finish</b>	Stain or Paint	Stain or Paint	Paint	Paint	Paint
<b>Panel – Top Rail</b>	Composite	Composite	Composite	Wood	Wood
<b>Panel – Bottom Rail</b>	Composite	Composite	Composite	Composite	Composite
<b>Lock Stile</b>	4" Full-Length Engineered Lumber	6'8": 1-1/4" Engineered Lumber 8'0": 3-15/16" Full-Length Engineered Lumber	6'8": 1-1/4" Engineered Lumber 8'0": 3-15/16" Full-Length Engineered Lumber	1-1/4" Wood	1-1/4" Wood
<b>Lock Block</b>	4" Full-Length Engineered Lumber Stile	22-1/2" Wood	12-1/2" Wood	12-1/2" Wood	6'8": 12-1/2" Wood / 8'0": 22-1/2" Wood
<b>Height Options</b>	6'8", 7'0" & 8'0"	6'6", 6'8", 7'0" & 8'0"	6'6", 6'8", 7'0" & 8'0"	6'6", 6'8" & 7'0"	6'8" & 8'0"
<b>Width Options</b>	2'6", 2'8", 2'10", 3'0" & 3'6"	2'0", 2'4", 2'6", 2'8", 2'10" & 3'0"	2'0", 2'4", 2'6", 2'8", 2'10", 3'0" & 3'6"	2'0", 2'4", 2'6", 2'8", 2'10", 3'0" & 3'6"	2'0", 2'4", 2'6", 2'8", 2'10" & 3'0"
<b>Panel Options</b>	Single, Double or Triple	Single, Double or Triple	Single, Double or Triple	Single, Double or Triple	Single, Double or Triple
<b>Sidelite Options</b>	12" & 14"	10", 12" & 14"	10", 12" & 14"	10", 12" & 14"	10", 12" & 14"
<b>Lite Frame Options</b>	SMC Frame	Advanta Frame, Standard Frame, PVC Frame	Advanta Frame, Standard Frame, PVC Frame	Standard Frame, PVC Frame	Standard Frame, PVC Frame
<b>Glass Options</b>	Deco / Privacy & Textured / Low-E IG	Deco / Privacy & Textured / Low-E / Clear IG	Deco / Privacy & Textured / Low-E / Clear IG	Deco / Privacy & Textured / Low-E / Clear IG	Deco / Privacy & Textured / Low-E / Clear IG
<b>Sill*</b>	Inswing: Composite Adjustable Outswing: Composite Outswing	Inswing: Value Composite Adjustable Outswing: Composite Outswing	Inswing: Value Composite Adjustable Outswing: Composite Outswing	Inswing: Value Composite Adjustable Outswing: Aluminum	Inswing: Value Composite Adjustable Outswing: Aluminum
<b>Weatherstrip - Hinge</b>	Medium-Reach	Medium-Reach	Medium-Reach	Medium-Reach	Medium-Reach
<b>Weatherstrip - Lock</b>	Medium-Reach	Long-Reach	Long-Reach	Long-Reach or Magnetic	Long-Reach or Magnetic
<b>Weatherstrip - Head</b>	Medium-Reach	Long-Reach	Long-Reach	Long-Reach or Magnetic	Long-Reach or Magnetic
<b>Multi-Point Lock</b>	Recommended	Recommended	Recommended	–	–
<b>Security Strike Plate</b>	Recommended	Recommended	Recommended	Recommended	Recommended
<b>Hinges*</b>	Classic Craft Ball-Bearing	Self-Aligning	Self-Aligning	Self-Aligning	Self-Aligning
<b>Frame*</b>	Composite Door Frame	Composite Door Frame	Composite Door Frame	Rot-Resistant	Primed Pine
<b>Screens &amp; Screen Accessories Available</b> Colors: Bronze, White	2" Frame	2" Frame	2" Frame	2" Frame	2" Frame
<b>Residential Limited Warranty</b>	Transferable Lifetime	Lifetime	Lifetime	10 Years	Door: 5 Years / Glass: 10 Years / Pulse 8'0": 10 Years

For dimensional data, see your Therma-Tru seller or visit [thermatru.com](http://thermatru.com) for a copy of the Therma-Tru Unit & Rough Opening Sizing Booklet.

# Therma-Tru® Door Systems

## Independent Laboratory Performance Testing

At the time of manufacture, Therma-Tru exterior door systems (properly assembled with all genuine Therma-Tru components) have been tested under one or more of the following performance specifications: structural load, uniform load deflection, vertical load resistance, air infiltration, water penetration resistance, forced entry resistance, operating forces, force to latch, deglazing resistance, operating cycle performance, impact resistance, sound transmission, thermal performance and solar heat gain performance. Therma-Tru exterior door systems conform to the applicable Performance Standards / Test Methods that may include ANSI/AAMA/NWDA 101/I.S.2, AAMA/WDMA 101/I.S.2/NAFS, AAMA/WDMA/CSA 101/I.S.2-A440, ASTM E330, ASTM E547, ASTM E283, ASTM E331, ANSI/BHMA A156.2, AAMA 1304, AAMA 920, AAMA 925, ASTM E2068, ASTM F842, ASTM E987, ASTM E1300, ASTM E90, ASTM E413, ASTM E1332, ASTM E1886, ASTM E1996, PA/TAS 201, PA/TAS 202, PA/TAS 203, HUD UM89, AAMA 1702.2, 24 CFR 3280, 24 CFR 3282, NFRC 100 and NFRC 200. Refer to [www.thermatru.com](http://www.thermatru.com) for design pressure and other performance ratings.

## Doors

**Recommended Door Overhang** – For best performance, all doors should be protected by an overhang. The recommended size is half the distance from the base of the door to the bottom of the overhang. So, as an example, a distance of 10' for this dimension would require an overhang of 5' minimum. For wetter climates, southern or western exposures, and for double doors, the overhang should be the same as the distance from the base of the door to the bottom of the overhang. In this same example, the dimension is 10' so the overhang should be 10'.

For best performance, double doors to be used in areas with severe weather exposure must be installed using entry alcoves or large soffit overhangs to protect entry unit from exposure. Multi-point locking systems are highly recommended for 8'0" and double door applications.

## Doorlites

Doorlites are insulated, and exposed panes are tempered or laminated. Optional wood grilles available for clear doorlites and transoms.

**Inserts** – All glass (except flush-glazed styles) shall be bedded with glazing mastic and secured in doors with screws. Therma-Tru's SMC and BTS doorlite frames are available for most styles except where noted. SMC and BTS frames shall resist significant deformation by heat up to 200 degrees Fahrenheit, regardless of paint or stain color or placement behind a storm door.

PVC doorlite frames must be finished within 30 days of installation. Failure to do so will increase the chance for product damage of the type that is not covered by the warranty. PVC doorlite frames are not recommended for use behind storm doors or to be painted dark colors, if exposed to direct sunlight.

**Decorative Glass & Wrought Iron** – Each Therma-Tru decorative glass unit is handcrafted by skilled artisans replicating Old World techniques. Each piece is a unique work of art and many things that would appear to be imperfections (small bubbles, lines and waves within the glass) are normal and are part of the designs character.

**Direct Set Sidelites** – All Therma-Tru direct set sidelites shall utilize trim components secured and glazed in place in the door jamb.

Condensation occurs naturally in the home, caused by excessive humidity in the air. Often this harmless water vapor can be seen collecting on glass surfaces, such as doorlites. Energy-efficient glass units in Therma-Tru door systems are constructed to keep the glass as warm as possible, reducing condensation build-up. However, there is no such thing as a condensation-free window or doorlite in high-humidity conditions.

A common attribute of true wrought iron doorlites is that a rattle sound may be heard when closing the door. This is solely a function of having real wrought iron which is heavy and has the ability to flex, moving back and forth within a narrow airspace surrounded by glass that has very little flex. This characteristic is not considered a defect or warranty issue.

**NOTE: Glass privacy ratings are determined by the 1/2-lite glass size. As a result, the amount of privacy / glass transparency may be more or less than indicated by the privacy rating, based on the glass design and size of the glass that is inserted into the door, sidelite or transom.**

Glass designs may differ from depiction due to the size and hand craftsmanship of glass. See your Therma-Tru seller or visit [www.thermatru.com](http://www.thermatru.com) for more details.

## Components

**Adjustable Security Strike Plate** – Proprietary adjustable type, permitting in-out adjustment of door in frame, up to 3/16".

**Hinges** – Minimum hinge size 4" x 4" x .098".

Ball-bearing hinges are recommended for 8'0" doors, doors using heavy lites (e.g., wrought iron), all 20-Minute Fire-rated fiberglass doors, Impact-rated doors and glass, and all Classic Craft doors.

Use of the multi-point locking system is highly recommended for 8'0" and double fiberglass doors. Not recommended for steel doors.

Please be aware that single door units built with public access sills have little resistance to water penetration, and double doors built with these sills have a potential to leak if installed exposed to weather. We recommend that units be installed away from weather under large soffits or overhangs.

Use of a sill pan is recommended.

Fiber-Classic and Smooth-Star dentil shelves are not recommended for placement behind storm doors or to be painted dark colors, if exposed to direct sunlight.

## Impact-Rated Products

Impact-rated products must be installed as part of a Therma-Tru door system in compliance with a Therma-Tru product approval. Visit [www.thermatru.com](http://www.thermatru.com) for product approvals and full details on WBDR- (Wind-Borne Debris Region) / HVHZ- (High Velocity Hurricane Zone) compliant products. Follow weather and news reports in order to assess severe weather situations and obey local authorities' shelter and evacuation orders. No product guarantees safety for persons or property, nor makes any premises hurricane- or impact-proof.

## Fire-Rating Performance Standards

Fire and building codes vary throughout the country and acceptance of products and labels is left to the discretion of the local authorities.

**MODIFICATION OF PRODUCTS DESCRIBED IN THIS BROCHURE WHICH CARRY FIRE RATINGS (DOORS AND FRAMES) MAY VOID THE FIRE RATINGS.**

Test conducted by Intertek, Warnock-Hersey.

## Limited Warranties

Please be aware of the applicable Therma-Tru Limited Warranty which contains important restrictions, disclaimers, exclusions and conditions, as well as the below listed Installation, Finishing & Maintenance documents, related to the Therma-Tru product purchased (e.g., Fiberglass, Steel, Patio Door Systems), all of which can be obtained from your Therma-Tru seller or found in their entirety at [www.thermatru.com](http://www.thermatru.com):

- Therma-Tru. Fiberglass and Steel Door Systems Residential Limited Warranty: Fiberglass – Classic Craft, Fiber-Classic, Smooth-Star, and Pulse. Door Systems; Steel – Pulse, Profiles, and Traditions Door Systems
- Therma-Tru. Tru-Defense. Door System Rider to Fiberglass Door Systems Limited Warranty: Classic Craft, Fiber-Classic, Smooth-Star, and Pulse. Fiberglass Door Systems
- EnLiten. Flush-Glazed Construction & Installation Rider to Fiberglass Door Systems Limited Warranty for Residential and Multi-Resident Premises: Classic Craft, Fiber-Classic, and Smooth-Star. Flush-Glazed Fiberglass Door Systems
- EnLiten. Flush-Glazed Homeowner Rider to Fiberglass Door Systems Limited Warranty for Residential and Multi-Resident Premises: Classic Craft, Fiber-Classic, and Smooth-Star. Flush-Glazed Fiberglass Door Systems
- PrismaGuard. Limited Warranty Rider to Fiberglass and Steel Door Systems Limited Warranty for Residential and Multi-Resident Premises: Fiberglass – Classic Craft, Fiber-Classic, Smooth-Star, and Pulse. Door Systems; Steel – Pulse, Profiles, and Traditions
- Same-Day. Stain 5-Year Limited Warranty: Same-Day. Stain and Topcoat for Use on Therma-Tru. Fiberglass Door Systems and Fypon. Stainable Polyurethane Products
- Therma-Tru. Composite Door Frame featuring Tru-Guard. Composite Technology Limited Warranty for Residential and Multi-Resident Premises: Classic Craft, Fiber-Classic, Smooth-Star, and Pulse. Fiberglass Door Systems
- Therma-Tru. Composite Door Frame featuring Tru-Guard. Composite Technology Limited Warranty Transferable Rider to Fiberglass Door Systems Limited Warranty for Residential and Multi-Resident Premises: Classic Craft, Fiber-Classic, Smooth-Star, and Pulse. Fiberglass Door Systems

## Installation, Finishing & Maintenance

Therma-Tru doors and sidelites come unfinished. Installation, finishing and maintenance must be performed according to Therma-Tru's recommendations to comply with warranty requirements. Obtain a copy of the following documents outlining recommendations from your Therma-Tru seller or find them in their entirety at [www.thermatru.com](http://www.thermatru.com):

- Installation Instructions (Products that are approved for Coastal and / or high wind applications may require special installation. Always follow the installation instructions in the Product Approval for these products.)
- Therma-Tru Fiberglass and Steel Door Systems Recommendations for Proper Finishing and Painting or Staining

**NOTE: Finish colors may vary from an actual application due to fluctuations in finishing or the printing of this catalog. See your Therma-Tru seller or visit [www.thermatru.com](http://www.thermatru.com) for more details.**

















S6565SL.....184	S807XK.....194	S8200.....207	S82XNSL.....167	S83400XC.....126	S84810XN.....136
S6568.....183	S807XN.....194	S8201.....208	S82XR.....166	S83400XE.....126	S84810XNSL.....136
S6570.....204	S807XR.....194	S8202SL.....170	S82XRSL.....167	S83400XJ.....126	S84810XR.....136
S6572.....194	S808.....157	S8204SL.....170	S830.....192	S83400XK.....126	S84810XRSL.....136
S6575.....174	S808SL.....157	S8207SL.....170	S830XC.....187	S83400XN.....126	S84812.....137
S6576.....174	S80XC.....167	S821.....144	S830XE.....187	S83400XR.....126	S84812SL.....137
S6577.....174	S80XE.....167	S82103.....132	S830XJ.....187	S83401.....207	S84812XC.....136
S6580.....164	S80XJ.....167	S82103XC.....131	S830XK.....187	S83500.....129	S84812XCNSL.....136
S6580SL.....164	S80XK.....167	S82103XE.....131	S830XN.....187	S83500XC.....126	S84812XE.....136
S6582.....164	S80XN.....167	S82103XJ.....131	S830XR.....187	S83500XE.....126	S84812XESL.....136
S668.....140	S80XR.....167	S82103XK.....131	S831.....208	S83500XJ.....126	S84812XJ.....136
S682.....167	S810.....208	S82103XN.....131	S8310.....170	S83500XK.....126	S84812XJSL.....136
S685L.....129	S81000.....208	S82103XR.....131	S8310SL.....170	S83500XN.....126	S84812XN.....136
S685LXC.....126	S81086SL.....158	S82104.....132	S8311.....169	S83500XR.....126	S84812XNSL.....136
S685LXE.....126	S81086XCSL.....152	S82105.....132	S8311SL.....170	S83501.....207	S84812XR.....136
S685LXJ.....126	S81086XESL.....152	S82105XJ.....131	S8312SL.....198	S83540.....200	S84812XRSL.....136
S685LXK.....126	S81086XJSL.....152	S82105XE.....131	S831203.....198	S83600.....130	S84813.....137
S685LXN.....126	S81086XKSL.....152	S82105XJ.....131	S831203XC.....197	S83600XC.....126	S84813XC.....136
S685LXR.....126	S81086XNSL.....152	S82105XK.....131	S831203XJ.....197	S83600XE.....126	S84813XE.....136
S685R.....130	S81086XRSL.....152	S82105XN.....131	S831203XK.....197	S83600XJ.....126	S84813XJ.....136
S685RXC.....126	S81100.....207	S82105XR.....131	S831203XK.....197	S83600XK.....126	S84813XN.....136
S685RXE.....126	S81186SL.....157	S82106.....132	S831203XN.....197	S83600XN.....126	S84813XR.....136
S685RXJ.....126	S8120.....208	S82106XC.....131	S831203XR.....197	S83600XR.....126	S84814.....137
S685RXK.....126	S81208.....157	S82106XE.....131	S83120XC.....198	S83601.....207	S84814XC.....136
S685RXN.....126	S81225.....153	S82106XJ.....131	S83120XE.....198	S837.....182	S84814XE.....136
S685RXR.....126	S8132.....188	S82106XK.....131	S83120XJ.....198	S8386.....185	S84814XJ.....136
S691.....129	S8132SL.....188	S82106XN.....131	S83120XK.....198	S8386SL.....185	S84814XN.....136
S691XC.....125	S814.....140	S82106XR.....131	S83120XC.....198	S8387.....185	S84814XR.....136
S691XE.....125	S8140.....158	S82107.....132	S83120XN.....198	S8390.....197	S84816.....137
S691XJ.....125	S81401.....132	S82107XC.....131	S8313.....170	S8392.....185	S84816XC.....136
S691XK.....125	S81405.....191	S82107XE.....131	S8313SL.....170	S84200.....134	S84816XE.....136
S691XN.....125	S8140STC.....205	S82107XJ.....131	S83142.....197	S84200SL.....134	S84816XJ.....136
S691XR.....125	S8140XC.....152	S82107XK.....131	S83143.....195	S84200XC.....133	S84816XN.....136
S6975.....200	S8140XE.....152	S82107XN.....131	S83147.....196	S84200XCNSL.....133	S84816XR.....136
S704.....203	S8140XJ.....152	S82107XR.....131	S83149.....196	S84200XE.....133	S84886SL.....132
S707.....202	S8140XK.....152	S82200.....132	S83152.....195	S84200XESL.....133	S84886SL.....137
S708.....203	S8140XN.....152	S82200XC.....131	S83153.....195	S84200XJ.....133	S84886XCNSL.....131
S709.....173	S8140XR.....152	S82200XE.....131	S83154.....196	S84200XJSL.....133	S84886XCNSL.....136
S7125SL.....191	S8141.....198	S82200XJ.....131	S83155.....196	S84200XN.....133	S84886XESL.....131
S721.....202	S8144.....191	S82200XK.....131	S8316.....170	S84200XNSL.....133	S84886XESL.....136
S735.....203	S8145.....191	S82200XN.....131	S8317.....204	S84200XR.....133	S84886XJSL.....131
S736.....202	S8145SL.....191	S82200XR.....131	S8318.....191	S84200XRSL.....133	S84886XJSL.....136
S745.....203	S8149.....182	S82213.....149	S8319.....191	S84305XC.....187	S84886XKSL.....131
S751SL.....171	S814SL.....140	S82213SL.....149	S832.....191	S84305XE.....187	S84886XKSL.....136
S751XCNSL.....167	S815.....140	S82223.....148	S8320.....191	S84305XJ.....187	S84886XNSL.....131
S751XESL.....167	S816.....139	S82223SL.....148	S83200.....134	S84305XK.....187	S84886XNSL.....136
S751XJSL.....167	S81645.....204	S82233.....150	S83200SL.....134	S84305XN.....187	S84886XRSL.....131
S751XKSL.....167	S81646.....165	S82233SL.....150	S83200XC.....133	S84305XR.....187	S84886XRSL.....136
S751XNSL.....167	S81646SL.....165	S82250.....132	S83200XCNSL.....133	S84308.....188	S8489.....186
S751XRSL.....167	S81649.....197	S822XC.....166	S83200XE.....133	S84309.....190	S8498.....185
S752.....203	S81650.....200	S822XE.....166	S83200XESL.....133	S84310.....185	S8498SL.....186
S755.....208	S81651.....147	S822XJ.....166	S83200XJ.....133	S84311.....184	S8508.....200
S757SL.....163	S81651SL.....147	S822XK.....166	S83200XJSL.....133	S84312.....191	S85225SL.....130
S758SL.....160	S81652.....147	S822XN.....166	S83200XN.....133	S84313.....190	S85225XCNSL.....126
S770.....174	S81652SL.....147	S822XR.....166	S83200XNSL.....133	S84314.....175	S85225XESL.....126
S771.....172	S81653.....184	S82382.....149	S83200XR.....133	S84315.....192	S85225XJSL.....126
S773.....173	S81654.....184	S82382SL.....149	S83200XRSL.....133	S84316.....182	S85225XKSL.....126
S774.....173	S81654SL.....184	S82385.....150	S8321.....191	S84318.....190	S85225XNSL.....126
S80.....171	S81656.....184	S82385SL.....150	S8321XC.....186	S84319.....176	S85225XRSL.....126
S8000.....130	S817.....141	S82389.....148	S8321XE.....186	S84320.....183	S85226SL.....129
S8000-12.....128	S818.....158	S82389SL.....148	S8321XJ.....186	S84321.....191	S85226XCNSL.....125
S8000-18.....128	S81828.....157	S82600.....126	S8321XK.....186	S84322.....186	S85226XCNSL.....125
S8000-9.....129	S818XC.....152	S82610.....201	S8321XN.....186	S84323.....183	S85226XJSL.....125
S8000SL.....132	S818XE.....152	S82610XC.....201	S8321XR.....186	S84324.....178	S85226XKSL.....125
S8000SL.....137	S818XJ.....152	S82610XE.....201	S8322.....190	S84325.....177	S85226XNSL.....125
S8000XC.....126	S818XK.....152	S82610XJ.....201	S8323.....190	S84326.....181	S85226XRSL.....125
S8000XCNSL.....131	S818XN.....152	S82610XN.....201	S8324.....190	S84327.....179	S85227SL.....130
S8000XCNSL.....136	S818XR.....152	S82610XR.....201	S8325.....191	S84328.....177	S85227XCNSL.....126
S8000XE.....126	S81929P.....192	S82620.....200	S8326.....190	S84329.....180	S85227XESL.....126
S8000XESL.....131	S81929PXC.....187	S82630.....199	S8327.....190	S84330.....180	S85227XJSL.....126
S8000XESL.....136	S81929PXE.....187	S82640.....200	S8328.....190	S84521.....165	S85227XKSL.....126
S8000XJ.....126	S81929PXJ.....187	S82650.....199	S832XC.....186	S84521SL.....165	S85227XNSL.....126
S8000XJSL.....131	S81929PXK.....187	S82660.....199	S832XE.....186	S84525.....165	S85227XRSL.....126
S8000XJSL.....136	S81929PXN.....187	S82670.....199	S832XJ.....186	S84525SL.....165	S85228SL.....130
S8000XK.....126	S81929PXR.....187	S828.....157	S832XK.....186	S84527.....166	S85228XCNSL.....126
S8000XKSL.....131	S81933P.....175	S829.....153	S832XN.....186	S84527SL.....166	S85228XESL.....126
S8000XKSL.....136	S81935P.....176	S829SL.....153	S832XR.....186	S84586SL.....140	S85228XJSL.....126
S8000XN.....126	S81936P.....176	S82SL.....170	S833.....177	S8467.....185	S85228XKSL.....126
S8000XNSL.....131	S81937P.....177	S82XC.....166	S83300.....129	S84800.....208	S85228XNSL.....126
S8000XNSL.....136	S81938P.....179	S82XCNSL.....167	S83300XC.....126	S84810.....137	S85228XRSL.....126
S8000XR.....126	S81939P.....178	S82XE.....166	S83300XE.....126	S84810SL.....137	S85229SL.....130
S8000XRSL.....131	S81940P.....179	S82XESL.....167	S83300XJ.....126	S84810XC.....136	S85229XCNSL.....126
S8000XRSL.....136	S81941P.....180	S82XJ.....166	S83300XK.....126	S84810XCNSL.....136	S85229XESL.....126
S807.....194	S81942P.....182	S82XJSL.....167	S83300XN.....126	S84810XE.....136	S85229XJSL.....126
S807XC.....194	S81983.....180	S82XK.....166	S83300XR.....126	S84810XESL.....136	S85229XKSL.....126
S807XE.....194	S82.....169	S82XKSL.....167	S83301.....207	S84810XJ.....136	S85229XNSL.....126
S807XJ.....194	S820.....145	S82XN.....166	S83400.....129	S84810XJSL.....136	S85229XRSL.....126

Fiber-Classic® & Smooth-Star® Continued

Index

S85230SL.....	207	S85901 .....	162	S8607XC .....	201	S880XR .....	167	S93203XR .....	197
S8529 .....	163	S85902 .....	163	S8607XE .....	201	S880XRSL .....	167	S9320XC .....	198
S8545SL .....	163	S85902SL .....	163	S8607XJ .....	201	S881 .....	170	S9320XE .....	198
S85700 .....	129	S85905 .....	175	S8607XN .....	201	S881SL .....	170	S9320XJ .....	198
S85700SL .....	207	S85907 .....	176	S8607XR .....	201	S881XC .....	166	S9320XK .....	198
S85700XC .....	125	S85908 .....	179	S8608 .....	201	S881XCSL .....	167	S9320XN .....	198
S85700XC SL .....	207	S85909 .....	180	S8608XC .....	201	S881XE .....	166	S9320XR .....	198
S85700XE .....	125	S85910SL .....	192	S8608XE .....	201	S881XESL .....	167	S9342 .....	197
S85700XESL .....	207	S85910XC SL .....	187	S8608XJ .....	201	S881XJ .....	166	S9343 .....	195
S85700XJ .....	125	S85910XESL .....	187	S8608XN .....	201	S881XJSL .....	167	S9347 .....	196
S85700XJSL .....	207	S85910XJSL .....	187	S8608XR .....	201	S881XK .....	166	S9349 .....	196
S85700XK .....	125	S85910XKSL .....	187	S8609 .....	199	S881XKSL .....	167	S9352 .....	195
S85700XKSL .....	207	S85910XNSL .....	187	S86107 .....	178	S881XN .....	166	S9353 .....	195
S85700XN .....	125	S85910XRSL .....	187	S86200 .....	134	S881XNSL .....	167	S9354 .....	196
S85700XNSL .....	207	S85912SL .....	175	S86200SL .....	134	S881XR .....	166	S9355 .....	196
S85700XR .....	125	S85914SL .....	176	S86200XC .....	133	S881XRSL .....	167	S95 .....	160
S85700XRSL .....	207	S85915SL .....	177	S86200XC SL .....	133	S882 .....	170	S960 .....	208
S85701 .....	207	S85916SL .....	178	S86200XE .....	133	S887 .....	160	S97 .....	163
S85705 .....	128	S85917SL .....	179	S86200XESL .....	133	S887SL .....	160	S971 .....	188
S85705XC .....	125	S85918SL .....	178	S86200XJ .....	133	S888 .....	160	S972 .....	175
S85705XE .....	125	S85920SL .....	182	S86200XJSL .....	133	S888SL .....	160	S973 .....	178
S85705XJ .....	125	S85922SL .....	180	S86200XNSL .....	133	S891 .....	161	S975 .....	159
S85705XK .....	125	S85924SL .....	157	S86200XR .....	133	S891SL .....	161	S975SL .....	159
S85705XN .....	125	S85925SL .....	157	S86200XRSL .....	133	S892 .....	162	S977 .....	160
S85705XR .....	125	S85926SL .....	157	S86201SL .....	135	S89200 .....	134	S979 .....	159
S8571 .....	145	S85927SL .....	139	S86240 .....	135	S89200XC .....	133	S981 .....	160
S85710 .....	129	S85928SL .....	153	S86240SL .....	135	S89200XE .....	133	S982 .....	161
S85710SL .....	207	S85930SL .....	145	S86500 .....	147	S89200XJ .....	133	S983 .....	162
S85710XC .....	125	S85931SL .....	141	S86500SL .....	147	S89200XN .....	133	S992 .....	174
S85710XC SL .....	207	S85932SL .....	143	S86520 .....	200	S89200XR .....	133	S997 .....	172
S85710XE .....	125	S85934SL .....	144	S86533 .....	197	S892SL .....	162	S999 .....	173
S85710XESL .....	207	S8600 .....	208	S86536 .....	184	S893 .....	178	SART .....	209
S85710XJ .....	125	S8600XC .....	201	S86550 .....	147	S894 .....	159		
S85710XJSL .....	207	S8600XE .....	201	S86550SL .....	147	S894SL .....	159		
S85710XK .....	125	S8600XJ .....	201	S86556 .....	183	S895 .....	161		
S85710XKSL .....	207	S8600XN .....	201	S86560SL .....	184	S895SL .....	161		
S85710XN .....	125	S8600XR .....	201	S86565 .....	183	S896 .....	205		
S85710XNSL .....	207	S8601 .....	201	S86570 .....	204	S896XC .....	205		
S85710XR .....	125	S8601SL .....	158	S86580 .....	164	S896XE .....	205		
S85710XRSL .....	207	S8601XC SL .....	152	S86580SL .....	164	S896XJ .....	205		
S85715 .....	128	S8601XESL .....	152	S8675 .....	191	S896XK .....	205		
S85715XC .....	125	S8601XJSL .....	152	S8675SL .....	183	S896KN .....	205		
S85715XE .....	125	S8601XKSL .....	152	S8682 .....	167	S896XR .....	205		
S85715XJ .....	125	S8601XNSL .....	152	S8682SL .....	167	S897 .....	208		
S85715XK .....	125	S8601XRSL .....	152	S8685 .....	129	S89701 .....	183		
S85715XN .....	125	S8602 .....	199	S8685LXC .....	126	S8971 .....	188		
S85715XR .....	125	S86021 .....	192	S8685LXE .....	126	S8972 .....	198		
S85720 .....	129	S86021XC .....	187	S8685LXJ .....	126	S898 .....	170		
S85720SL .....	207	S86021XE .....	187	S8685LXK .....	126	S898SL .....	170		
S85720XC .....	125	S86021XJ .....	187	S8685LXN .....	126	S90 .....	171		
S85720XC SL .....	207	S86021XK .....	187	S8685LXR .....	126	S902 .....	164		
S85720XE .....	125	S86021XN .....	187	S8685R .....	130	S902SL .....	164		
S85720XESL .....	207	S86021XR .....	187	S8685RX .....	126	S90SL .....	132		
S85720XJ .....	125	S86022XC .....	186	S8685RXJ .....	126	S90XC .....	167		
S85720XJSL .....	207	S86022XE .....	186	S8685RXK .....	126	S90XE .....	167		
S85720XK .....	125	S86022XJ .....	186	S8685RXN .....	126	S90XJ .....	167		
S85720XKSL .....	207	S86022XK .....	186	S8685RXR .....	126	S90XK .....	167		
S85720XN .....	125	S86022XN .....	186	S8691 .....	129	S90XN .....	167		
S85720XNSL .....	207	S86022XR .....	186	S8691 .....	125	S90XR .....	167		
S85720XR .....	125	S86025 .....	177	S8691 .....	125	S91 .....	160		
S85720XRSL .....	207	S86026 .....	182	S8691 .....	125	S912 .....	163		
S85721 .....	207	S86027 .....	176	S8691 .....	125	S916 .....	140		
S85725 .....	129	S86029 .....	179	S8691 .....	125	S916SL .....	140		
S85725XC .....	125	S8602SL .....	142	S8691 .....	125	S91SL .....	160		
S85725XE .....	125	S86030 .....	180	S8691 .....	125	S92 .....	170		
S85725XJ .....	125	S86031 .....	177	S8691 .....	125	S9200 .....	134		
S85725XK .....	125	S86032 .....	175	S8691 .....	200	S9200XC .....	133		
S85725XN .....	125	S86035 .....	188	S8704 .....	203	S9200XE .....	133		
S85725XR .....	125	S86036 .....	183	S8707 .....	202	S9200XJ .....	133		
S8572SL .....	145	S8604 .....	199	S8708 .....	203	S9200XN .....	133		
S8573SL .....	145	S8605 .....	201	S8721 .....	202	S9200XR .....	133		
S8574 .....	144	S8605SL .....	157	S8735 .....	203	S925 .....	198		
S8575 .....	181	S8605XC .....	200	S8736 .....	202	S92SL .....	132		
S8579 .....	181	S8605XE .....	200	S8745 .....	203	S92XC .....	166		
S8581 .....	181	S8605XJ .....	200	S8752 .....	203	S92XE .....	166		
S8583SL .....	181	S8605XN .....	200	S880 .....	171	S92XJ .....	166		
S85892 .....	139	S8605XR .....	200	S880SL .....	171	S92XK .....	166		
S85892SL .....	139	S8606 .....	201	S880XC .....	167	S92XN .....	166		
S85893 .....	141	S8606SL .....	157	S880XC SL .....	167	S92XR .....	166		
S85893SL .....	141	S8606XC .....	200	S880XE .....	167	S93 .....	207		
S85895 .....	145	S8606XE .....	200	S880XESL .....	167	S9320 .....	198		
S85895SL .....	145	S8606XJ .....	200	S880XJ .....	167	S93203 .....	198		
S85896 .....	144	S8606XN .....	200	S880XJSL .....	167	S93203XC .....	197		
S85896SL .....	144	S8606XR .....	200	S880XK .....	167	S93203XE .....	197		
S85897 .....	178	S8607 .....	201	S880XKSL .....	167	S93203XJ .....	197		
S85898 .....	161	S8607A .....	179	S880XN .....	167	S93203XK .....	197		
S85898SL .....	161	S8607SL .....	157	S880XNSL .....	167	S93203XN .....	197		



# Steel *Continued*

Index

TS105.....	236	TS296XCSSL.....	237
TS108.....	234	TS296XE.....	237
TS108XC.....	234	TS296XESL.....	237
TS108XE.....	234	TS296XJ.....	237
TS108XJ.....	234	TS296XJSL.....	237
TS108XK.....	234	TS296XK.....	237
TS108XN.....	234	TS296XKSL.....	237
TS108XR.....	234	TS296XN.....	237
TS115.....	236	TS296XNSL.....	237
TS118.....	235	TS296XR.....	237
TS118XC.....	234	TS296XRSL.....	237
TS118XE.....	234	TS72SL.....	221
TS118XJ.....	234	TS704.....	237
TS118XK.....	234	TS708.....	238
TS118XN.....	234	TS752.....	237
TS118XR.....	234		
TS1200.....	234		
TS1201.....	234		
TS1202.....	234		
TS1203.....	234		
TS128.....	234		
TS128XC.....	234		
TS128XE.....	234		
TS128XJ.....	234		
TS128XK.....	234		
TS128XN.....	234		
TS128XR.....	234		
TS130.....	234		
TS131.....	236		
TS132.....	236		
TS132SL.....	236		
TS137.....	236		
TS1405SL.....	236		
TS1408.....	236		
TS1411.....	237		
TS198.....	235		
TS206.....	236		
TS206XC.....	235		
TS206XE.....	235		
TS206XJ.....	235		
TS206XK.....	235		
TS206XN.....	235		
TS206XR.....	235		
TS210.....	238		
TS210SL.....	236		
TS210XCSSL.....	235		
TS210XESL.....	235		
TS210XJSL.....	235		
TS210XKSL.....	235		
TS210XNSL.....	235		
TS210XRSL.....	235		
TS236.....	237		
TS237.....	238		
TS243.....	236		
TS255.....	237		
TS256.....	238		
TS262.....	236		
TS262XC.....	235		
TS262XE.....	235		
TS262XJ.....	235		
TS262XK.....	235		
TS262XN.....	235		
TS262XR.....	235		
TS263.....	237		
TS263SL.....	236		
TS263XC.....	237		
TS263XCSSL.....	235		
TS263XE.....	237		
TS263XESL.....	235		
TS263XJ.....	237		
TS263XJSL.....	235		
TS263XK.....	237		
TS263XKSL.....	235		
TS263XN.....	237		
TS263XNSL.....	235		
TS263XR.....	237		
TS263XRSL.....	235		
TS289.....	237		
TS289XC.....	237		
TS289XE.....	237		
TS289XJ.....	237		
TS289XK.....	237		
TS289XN.....	237		
TS289XR.....	237		
TS296.....	238		
TS296SL.....	238		
TS296XC.....	237		

# Fire

100.....	243
1005HD.....	243
203HD.....	243
205HD.....	243
210HD.....	243
969HD.....	243
978HD.....	243
SSF100.....	243
SSF1100.....	242
SSF120.....	242
SSF160.....	243
SSF200.....	242
SSF205.....	242
SSF220.....	242
SSF31.....	242
SSF45.....	242
SSF4800.....	242
SSF600.....	243
SSF755.....	242
SSF8100.....	243
SSF81100.....	242
SSF8120.....	242
SSF8160.....	243
SSF8200.....	242
SSF8205.....	242
SSF8220.....	242
SSF831.....	242
SSF84800.....	242
SSF8600.....	243
SSF93.....	242
SSF960.....	242
TS100.....	243
TS210.....	243

# Pulse®

DRS2131SL.....	255	S4CLSL.....	256	S81086XNSL.....	255
DRS82131SL.....	255	S4LAX.....	252	S81086XRSL.....	255
S10AXSL.....	256	S4LCL.....	253	S810AX.....	253
S10CLSL.....	256	S4LPB.....	251	S810AXSL.....	256
S10PBSL.....	255	S4LXC.....	253	S810CL.....	254
S10XCGL.....	256	S4LXE.....	253	S810CLSL.....	256
S10XESL.....	256	S4LXJ.....	253	S810LAX.....	253
S10XJSL.....	256	S4LXK.....	253	S810LCL.....	254
S10XKSL.....	256	S4LXN.....	253	S810LCLSL.....	256
S10XNSL.....	256	S4LXR.....	253	S810LXC.....	254
S10XRSL.....	256	S4PB.....	251	S810LXE.....	254
S1651SL.....	255	S4PBSL.....	255	S810LXJ.....	254
S1AX.....	250	S4RAX.....	252	S810LXC.....	254
S1BL.....	248	S4RCL.....	253	S810LXN.....	254
S1BS.....	248	S4RPB.....	251	S810LXSL.....	256
S1CL.....	250	S4RXC.....	253	S810LXR.....	254
S1CX.....	250	S4RXE.....	253	S810LXX.....	254
S1EC.....	250	S4RXJ.....	253	S810LXN.....	254
S1LAX.....	250	S4RXK.....	253	S810LXR.....	254
S1LBL.....	248	S4RXN.....	253	S810PB.....	252
S1LBS.....	248	S4RXL.....	253	S810PB.....	252
S1LCL.....	250	S4XC.....	253	S810PB.....	252
S1LCX.....	250	S4XCSSL.....	256	S810PBL.....	255
S1LEC.....	250	S4XE.....	253	S810PBL.....	255
S1LLT.....	250	S4XESL.....	256	S810PBL.....	255
S1LPB.....	249	S4XJ.....	253	S810PBL.....	255
S1LRS.....	249	S4XJSL.....	256	S810RAX.....	253
S1LSA.....	249	S4XK.....	253	S810RCL.....	254
S1LSG.....	249	S4XKSL.....	256	S810RCL.....	254
S1LSN.....	249	S4XN.....	253	S810RCL.....	254
S1LT.....	250	S4XNSL.....	256	S810RCL.....	254
S1LXC.....	250	S4XR.....	253	S810RCL.....	254
S1LXE.....	250	S4XRSL.....	256	S810RCL.....	254
S1LXN.....	250	S572SL.....	255	S810RCL.....	254
S1LXR.....	250	S5AX.....	252	S810RCL.....	254
S1PB.....	249	S5AXSL.....	256	S810RCL.....	254
S1RAX.....	250	S5CL.....	254	S810RCL.....	254
S1RBL.....	249	S5CLSL.....	256	S810RCL.....	254
S1RBS.....	248	S5LAX.....	252	S810RCL.....	254
S1RCL.....	250	S5LCL.....	253	S810RCL.....	254
S1RCX.....	250	S5LPB.....	251	S810RCL.....	254
S1REC.....	250	S5LXC.....	253	S810RCL.....	254
S1RLT.....	250	S5LXE.....	253	S810RCL.....	254
S1RPB.....	249	S5LXJ.....	253	S810RCL.....	254
S1RRS.....	249	S5LXK.....	253	S810RCL.....	254
S1RS.....	249	S5LXN.....	253	S810RCL.....	254
S1RSA.....	249	S5LXR.....	253	S810RCL.....	254
S1RSG.....	249	S5PB.....	251	S810RCL.....	254
S1RSN.....	249	S5PBSL.....	255	S810RCL.....	254
S1RXC.....	250	S5RAX.....	252	S810RCL.....	254
S1RXE.....	250	S5RCL.....	254	S810RCL.....	254
S1RXJ.....	250	S5RPB.....	251	S810RCL.....	254
S1RXK.....	250	S5RXC.....	254	S810RCL.....	254
S1RXN.....	250	S5RXE.....	254	S810RCL.....	254
S1RXR.....	250	S5RXJ.....	254	S810RCL.....	254
S1SA.....	249	S5RXK.....	254	S810RCL.....	254
S1SG.....	249	S5RXN.....	254	S810RCL.....	254
S1SN.....	249	S5RXL.....	254	S810RCL.....	254
S1XC.....	250	S5XC.....	254	S810RCL.....	254
S1XE.....	250	S5XCSSL.....	256	S810RCL.....	254
S1XJ.....	250	S5XE.....	254	S810RCL.....	254
S1XK.....	250	S5XESL.....	256	S810RCL.....	254
S1XN.....	250	S5XJ.....	254	S810RCL.....	254
S1XR.....	250	S5XJSL.....	256	S810RCL.....	254
S2382SL.....	255	S5XK.....	254	S810RCL.....	254
S2385SL.....	255	S5XKSL.....	256	S810RCL.....	254
S2389SL.....	255	S5XN.....	254	S810RCL.....	254
S2AX.....	248	S5XNSL.....	256	S810RCL.....	254
S2CL.....	248	S5XR.....	254	S810RCL.....	254
S2CX.....	248	S5XRSL.....	256	S810RCL.....	254
S2EC.....	248	S601SL.....	255	S810RCL.....	254
S2PB.....	248	S601XCSSL.....	255	S810RCL.....	254
S2RS.....	248	S601XESL.....	255	S810RCL.....	254
S2SG.....	248	S601XJSL.....	255	S810RCL.....	254
S2SN.....	248	S601XKSL.....	255	S810RCL.....	254
S2XC.....	248	S601XNSL.....	255	S810RCL.....	254
S2XE.....	248	S601XRSL.....	255	S810RCL.....	254
S2XJ.....	248	S602SL.....	255	S810RCL.....	254
S2XK.....	248	S604SL.....	255	S810RCL.....	254
S2XN.....	248	S6130SL.....	255	S810RCL.....	254
S2XR.....	248	S6134SL.....	255	S810RCL.....	254
S4570SL.....	255	S6500SL.....	255	S810RCL.....	254
S4AX.....	252	S81086SL.....	255	S810RCL.....	254
S4AXSL.....	256	S81086XCSSL.....	255	S810RCL.....	254
S4CL.....	253	S81086XESL.....	255	S810RCL.....	254
		S81086XJSL.....	255	S810RCL.....	254
		S81086XKSL.....	255	S810RCL.....	254



S81LLT.....	250	S84XK.....	253	S8LPB.....	251
S81LPB.....	249	S84XKSL.....	256	S8LXC.....	254
S81LRS.....	249	S84XN.....	253	S8LXE.....	254
S81LSA.....	249	S84XNSL.....	256	S8LXJ.....	254
S81LSG.....	249	S84XR.....	253	S8LXK.....	254
S81LT.....	250	S84XRSL.....	256	S8LXN.....	254
S81LXC.....	250	S8572SL.....	255	S8LXR.....	254
S81LXE.....	250	S85927SL.....	255	S8PB.....	251
S81LXJ.....	250	S85931SL.....	255	S8RAX.....	253
S81LXK.....	250	S85932SL.....	255	S8RCL.....	254
S81LXN.....	250	S85AX.....	252	S8RPB.....	251
S81LXR.....	250	S85AXSL.....	256	S8RXC.....	254
S81PB.....	249	S85CL.....	254	S8RXE.....	254
S81RAX.....	250	S85CLSL.....	256	S8RXJ.....	254
S81RBL.....	249	S85LAX.....	252	S8RXK.....	254
S81RBS.....	248	S85LCL.....	253	S8RXN.....	254
S81RCL.....	250	S85LPB.....	251	S8RXR.....	254
S81RCX.....	250	S85LXC.....	253	S8XC.....	254
S81REC.....	250	S85LXE.....	253	S8XE.....	254
S81RLT.....	250	S85LXJ.....	253	S8XJ.....	254
S81RPB.....	249	S85LXK.....	253	S8XK.....	254
S81RRS.....	249	S85LXN.....	253	S8XN.....	254
S81RS.....	249	S85LXR.....	253	S8XR.....	254
S81RSA.....	249	S85PB.....	251	S9AX.....	253
S81RSG.....	249	S85PBSL.....	255	S9AXSL.....	256
S81RXC.....	250	S85RAX.....	252	S9CL.....	254
S81RXE.....	250	S85RCL.....	254	S9CDSL.....	256
S81RXJ.....	250	S85RPB.....	251	S9LAX.....	253
S81RXK.....	250	S85RXC.....	254	S9LCL.....	254
S81RXN.....	250	S85RXE.....	254	S9LPC.....	251
S81RXR.....	250	S85RXJ.....	254	S9LXC.....	254
S81SA.....	249	S85RXK.....	254	S9LXE.....	254
S81SG.....	249	S85RXN.....	254	S9LXJ.....	254
S81XC.....	250	S85RXX.....	254	S9LXK.....	254
S81XE.....	250	S85RXXR.....	254	S9LXN.....	254
S81XJ.....	250	S85XC.....	254	S9LXR.....	254
S81XK.....	250	S85XCGL.....	256	S9PB.....	251
S81XN.....	250	S85XE.....	254	S9PBSL.....	255
S81XR.....	250	S85XESL.....	256	S9RAX.....	253
S82382SL.....	255	S85XJ.....	254	S9RCL.....	254
S82385SL.....	255	S85XJSL.....	256	S9RPB.....	251
S82389SL.....	255	S85KK.....	254	S9RXC.....	254
S83AX.....	248	S85KSL.....	256	S9RXE.....	254
S83CL.....	248	S85XN.....	254	S9RXJ.....	254
S83CX.....	248	S85XNSL.....	256	S9RXK.....	254
S83EC.....	248	S85XR.....	254	S9RXN.....	254
S83PB.....	248	S85XRSL.....	256	S9RXX.....	254
S83RS.....	248	S86500SL.....	255	S9XC.....	254
S83SG.....	248	S86AX.....	252	S9XCGL.....	256
S83SN.....	248	S86AXSL.....	256	S9XE.....	254
S83XC.....	248	S86CL.....	254	S9XESL.....	256
S83XE.....	248	S86CLSL.....	256	S9XJ.....	254
S83XJ.....	248	S86LAX.....	252	S9XJSL.....	256
S83XK.....	248	S86LCL.....	254	S9XK.....	254
S83XN.....	248	S86LPB.....	251	S9XKSL.....	256
S83XR.....	248	S86LXC.....	254	S9XN.....	254
S84586SL.....	255	S86LXE.....	254	S9XNSL.....	256
S84AX.....	252	S86LXJ.....	254	S9XR.....	254
S84AXSL.....	256	S86LXK.....	254	S9XRSL.....	256
S84CL.....	253	S86LXCGL.....	254		
S84CLSL.....	256	S86LXN.....	254		
S84LAX.....	252	S86LXR.....	254		
S84LCL.....	253	S86PB.....	251		
S84LPB.....	251	S86PBSL.....	255		
S84LXC.....	253	S86RAX.....	252		
S84LXE.....	253	S86RCL.....	254		
S84LXJ.....	253	S86RPB.....	251		
S84LXK.....	253	S86RXC.....	254		
S84LXN.....	253	S86RXE.....	254		
S84LXR.....	253	S86RXJ.....	254		
S84PB.....	251	S86RXK.....	254		
S84PBSL.....	255	S86RXN.....	254		
S84RAX.....	252	S86RXX.....	254		
S84RCL.....	253	S86XC.....	254		
S84RPB.....	251	S86XCGL.....	256		
S84RXC.....	253	S86XE.....	254		
S84RXE.....	253	S86XESL.....	256		
S84RXJ.....	253	S86XJ.....	254		
S84RXK.....	253	S86XJSL.....	256		
S84RXN.....	253	S86KK.....	254		
S84RXR.....	253	S86KSL.....	256		
S84XC.....	253	S86XN.....	254		
S84XCGL.....	256	S86XNSL.....	256		
S84XE.....	253	S86XR.....	254		
S84XESL.....	256	S86XRSL.....	256		
S84XJ.....	253	S8AX.....	253		
S84XJSL.....	256	S8CL.....	254		
		S8LAX.....	253		
		S8LCL.....	254		



Top: Fiber-Classic Mahogany Collection, Calix Glass, Door – FCM82223, Finish – Acorn  
 Bottom: Impressions Storm & Entry Door System – IM8100, Finish – White; Fiber-Classic Mahogany Collection, Chord Glass, Door – FCM84810XC, Finish – Tumbleweed



Top Right: Classic Craft Walnut Grain Door - CCW8901L; Low-E Glass Direct Set Sidelites - DRS82131SL, Finish - Tumbleweed  
Bottom: Smooth-Star, Latitude Glass, Doors - S4525, Finish - Onyx

# Tools of the Trade

Check out these helpful resources for dealers, builders and remodelers.

## Architectural Home Styles Guide

Get inspired to choose entry doors by design with our interactive guide to popular home styles at [thermatru.com/inspiration](http://thermatru.com/inspiration).



## Advancement Center

Learn about Therma-Tru products and programs on our new online training platform at [brainshark.com/thermatru](http://brainshark.com/thermatru).



## Certified Door System Installation Program

Build your knowledge, skills and confidence with comprehensive door system installer training from Therma-Tru – the expert in fiberglass door systems – and OSI® – the expert in construction sealants. Get started today at [thermatru.com/installer](http://thermatru.com/installer).



## Digital Vault

Explore the Digital Vault to find logos, images, literature and more to help you promote the Therma-Tru products you offer. Create an account today at [thermatru.widencollective.com/login](http://thermatru.widencollective.com/login).



## Trade Professionals Online

Find everything from selling tools and training materials to technical information at [thermatru.com/professionals](http://thermatru.com/professionals).



## Design Your Door

Homeowners can research and design a door with their own personal touch – all from the convenience of home. To get started, visit [thermatru.com/design-your-door](http://thermatru.com/design-your-door).

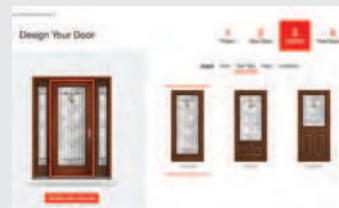



# THERMA TRU® DOORS

[thermatru.com](http://thermatru.com)

1-800-THERMA-TRU (843-7628)

1750 Indian Wood Circle  
Maumee, OH 43537



#thermatru

Cover: Classic Craft Fir Grain Door – CCA81166; Low-E Glass, Sidelites – CCA3500SL, Finish – Acorn  
Back Cover: Classic Craft Mahogany Grain, Low-E Glass with SDLs, Door – CCM82806, Finish – Tumbleweed

©2024 Therma-Tru Corp. All rights reserved. All trademarks and images featured are owned by their respective company and used with permission. Registered trademarks are registered in the U.S. and may be registered internationally. Therma-Tru Corp. and Larson Manufacturing Company, LLC are part of Fortune Brands Innovations, Inc. – an industry-leading home and security products company. ENERGY STAR is a government program that helps consumers protect the environment through superior energy efficiency and is a registered trademark of the U.S. Department of Energy and the U.S. Environmental Protection Agency.

Part #MAFL2024 HESB / JAN 2024