

Folding Glass Doors

THERMA TRU[®]
DOORS



Veris[™]
COLLECTION

Possibilities unfold.

Connect indoor and outdoor spaces with a flexible and customizable opening. Veris folding glass door systems glide open and shut with ease. Explore convenient options, including an optional swing door that allows homeowners to easily enter or exit a room without opening all the panels.

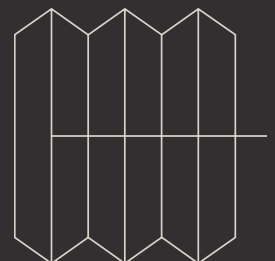

Confidence in a Complete System

Create the ultimate open-air living experience with superior performance thanks to our full-system approach. With the Veris™ collection, each piece is engineered to work together seamlessly. Folding doors are available in top-load and bottom-load systems.

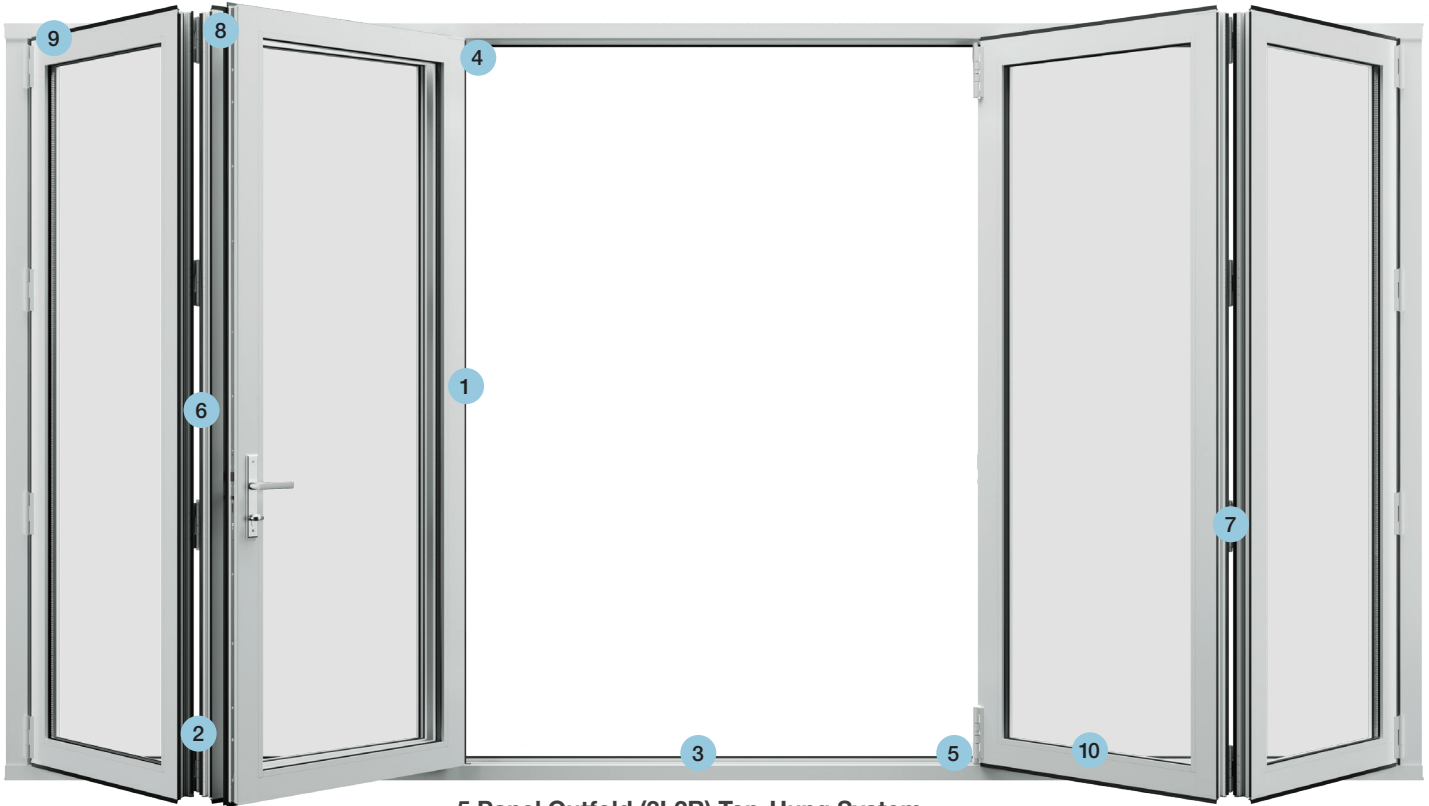

5 Panel Outfold (3L2R) Top-Hung System
Shown from the exterior side of the door system.



Thermal break design separates interior and exterior aluminum to reduce heat and cold transfer between indoors and outdoors which helps reduce condensation.



Semi-concealed hinges built into the panels blend with the door system. Manufactured in-house to high tolerances under tight quality control. Color match options are available.

*Door systems built with a flush sill have little resistance to water penetration and have a potential to leak if installed exposed to weather. We recommend these systems be installed away from weather under large soffits or overhangs.

**For ADA compliance, the door must provide a minimum 32" clear opening width. Verify all other ADA compliance requirements with your local building code official.

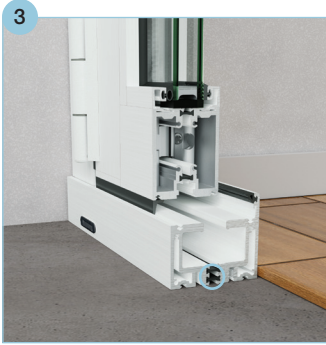

Standard



Recessed Standard

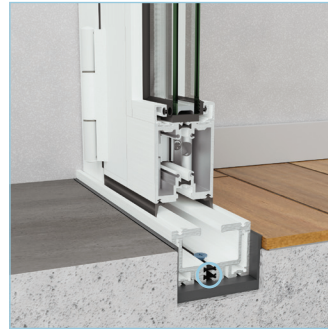

Recessed Flush*

Thermally broken sills reduce the transfer of heat and cold through the door system for greater energy efficiency while reducing condensation buildup.

Install as a **standard** or **recessed standard sill** for better water resistance, or a **recessed flush sill** for a seamless appearance.

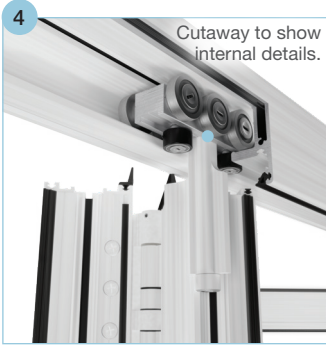

Trolleys carry the load of the door system from either the top or bottom of the assembly, depending on the hanging configuration. Assembled in-house with sealed precision ball bearings to help protect from dust and other debris for smooth and quiet operation.

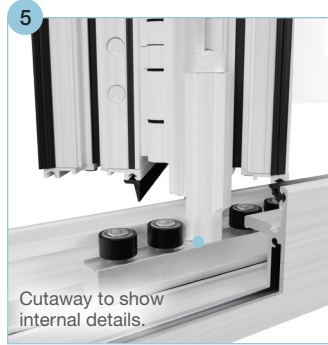

Non-load-bearing **idlers** are designed to smoothly guide the door panels. Assembled in-house with sealed precision ball bearings to help protect from dust and other debris for smooth and quiet operation.



A **two-point lock** secures each panel against the compression seal for a tight bond. Designed for intuitive, ergonomic use while maintaining a low profile. Color match options are available.



Hinge pulls offer an easy, low-profile way to close door panels on outfold systems while helping to keep fingers away from pinch points. Made in-house to high tolerances. Color match options are available.



A **door catch** holds the door open. Made in-house for tight quality control. Color match options are available.

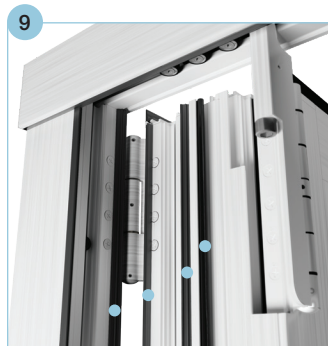

Designed to provide the best possible fit between panel and frame, **compression seals** help prevent water and air from entering the home.

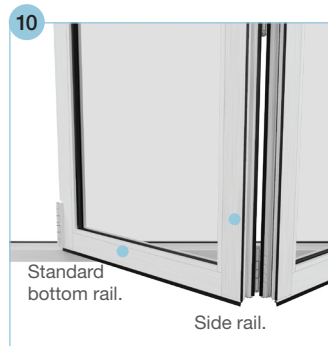

Top and side rails are 3-3/8" wide, maximizing the view through each panel. Available with **standard bottom rails** that match the height of the top rail and width of the side rails or **10" bottom rails** which deliver the beauty of glass while meeting ADA compliance.**



V-2 vs. V-3



**V-2 Systems:
Built for everyday life.**

Our V-2 systems are designed to meet the needs for most homes and structures. Featuring our standard components that are quality tested for long-term use, the V-2 system is perfect for residential dwellings in most areas of the United States.

Panel & System Thickness: 2-1/4"
Maximum Height: 8'



**V-3 Systems:
Performance where you need it.**

Our V-3 systems are engineered to meet the high-performance needs of specific regions, building codes and commercial structures, and are built to support larger glass panels found in our taller units. With high-performance components that can stand up to heavy-duty use, the V-3 system is ideal for structures and door units that require extra support and stability.

Panel & System Thickness: 3"
Maximum Height: 10'

Size Offering

Folding configurations with panels that exceed 8'0" in height will be built as a V-3 system.

System		2-Panel	3-Panel	4-Panel	5-Panel	6-Panel
Panel Width		3'0"	3'0"	3'0"	3'0"	3'0"
Height	6'8"					
	7'0"					
	8'0"					
	9'0"					
	10'0"					

Standard Lead Time
 Extended Lead Time



Configurations

Available as infold or outfold. Select configurations are available with single swing door operation for easy access to outdoor spaces without opening the entire folding unit. Look for the panels outlined in red.

Shown from the exterior side of the door system.

2 Panels

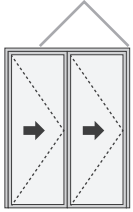

2R

All panels fold to right.

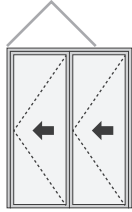

2L

All panels fold to left.

3 Panels

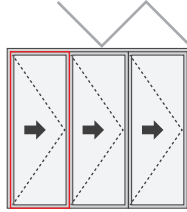

3R

All panels fold to right.

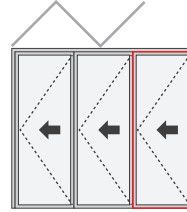

3L

All panels fold to left.

4 Panels

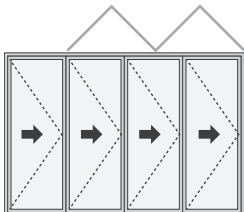

4R

All panels fold to right.

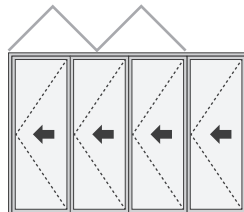

4L

All panels fold to left.

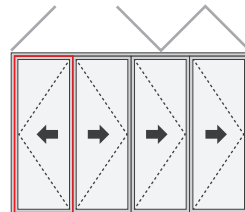

1L3R

One panel folds to left / three panels fold to right.

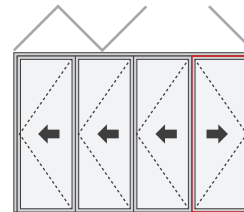

3L1R

Three panels fold to left / one panel folds to right.

5 Panels

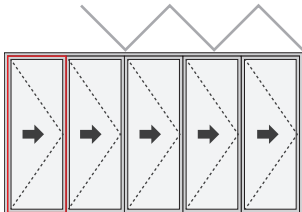

5R

All panels fold to right.

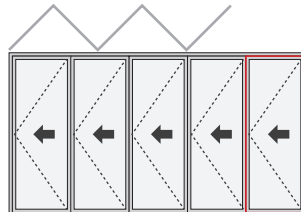

5L

All panels fold to left.

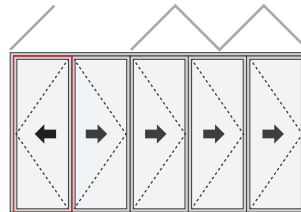

1L4R

One panel folds to left / four panels fold to right.

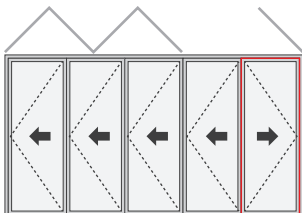

4L1R

Four panels fold to left / one panel folds to right.

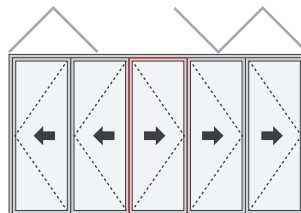

2L3R

Two panels fold to left / three panels fold to right.

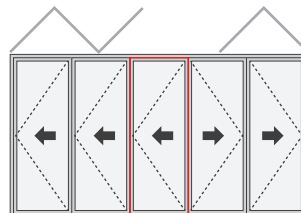

3L2R

Three panels fold to left / two panels fold to right.

6 Panels

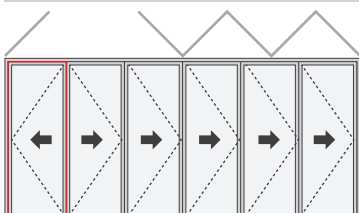

1L5R

One panel folds to left / five panels fold to right.

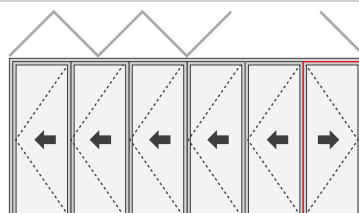

5L1R

Five panels fold to left / one panel folds to right.

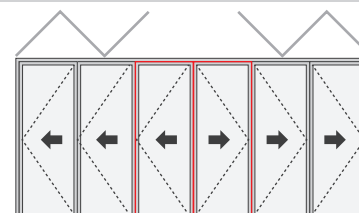

3L3R

Three panels fold to left / three panels fold to right.

Glass Options



Enhanced Low-E

Blocks 95% of the sun's harmful UV rays, helping to preserve the color and materials of your interior furnishings, draperies and wall treatments.*



Low-E

Delivers exceptional energy efficiency, retaining heat in the winter and reflecting it in the summer.



Turtle with Low-E

Tinted gray to reduce interior light projection as required near sea turtle nesting areas. Includes Low-E coating for exceptional energy efficiency.

Optional Neat+™ Coating

All Low-E glass in the Veris collection is available with Neat+ coating. This low-maintenance coating is designed to help keep glass clear and free of watermarks, reducing the need for cleaning.*



Without Neat+ Coating

With Neat+ Coating

Divided Lites

Available Patterns



1X3

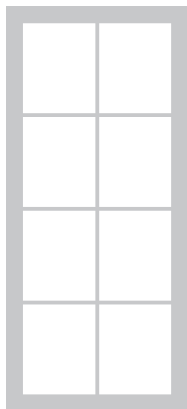

2X4

Grilles Between Glass (GBGs)



GBGs are sealed between two panes of tempered glass for a smooth easy-to-clean surface.

Height: $\frac{5}{8}$ "
Depth: $\frac{3}{16}$ "

Finish Options for GBGs

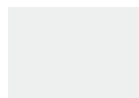

White



Black

Split finish not available for GBGs.

Simulated Divided Lites (SDLs) with Grilles Between Glass (GBGs)

SDLs are adhered to the interior and exterior panes of tempered glass and are finished to complement the door system. For a more authentic divided lite look, SDLs are layered over black GBGs.

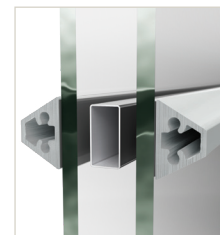

Traditional Profile

Height: $\frac{3}{4}$ "
Depth: $1\frac{5}{32}$ "

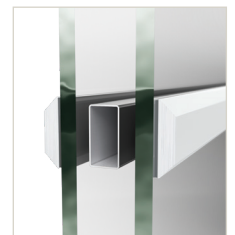

Flat Profile

Height: $\frac{3}{4}$ "
Depth: $\frac{5}{32}$ "

Screen Options by Genius

Welcome a fresh breeze into the home while keeping insects and debris out. Sheer screens glide open and shut with the touch of a finger and include convenient latching options at the center, right or left to best fit the home.

Screens are pre-assembled for fast and easy installation compared to other screens. For outfold systems, screens are installed on the interior side. For infold systems, screens are installed on the exterior side. Available in white and black.

ZigZag2 Screens

- Designed to fit standard openings.
- Maximum Height: 8'
- Maximum Unit Width: 12'

Sheer Classic Screens

- Designed to fit wide openings.
- Feature a thin flat bottom guide.
- Maximum Height: 10'
- Maximum Single Panel Width: 57-½"
- Overall Width Sized to Unit



Scan to learn more about screen options.

THERMA TRU
DOORS



Finish

Choose from an on-trend assortment of finishes designed to complement most homes.

Standard Lead Powder Coated

Similar to semi-gloss finish.

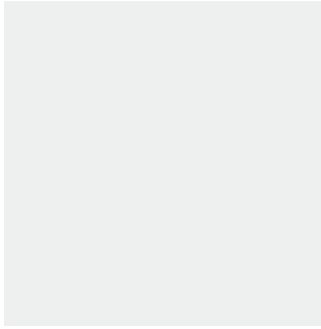

White

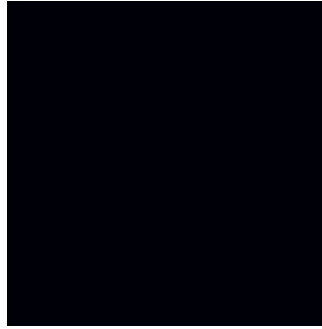

Black

Standard Lead Anodized

Similar to eggshell finish.



Clear

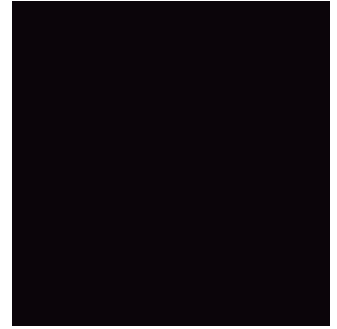

Dark Bronze

Extended Lead Powder Coated

Similar to semi-gloss finish.

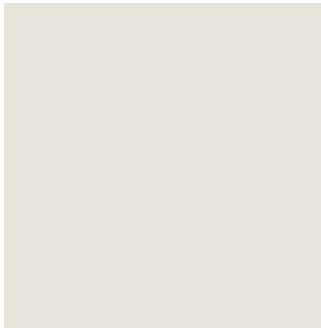

Bone White

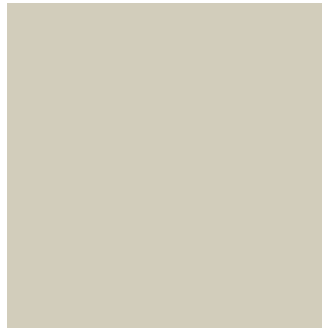

Sandstone

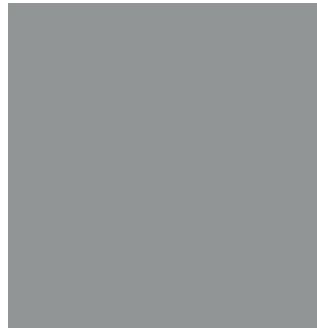

Fashion Gray



Charcoal



White / Black

Additional Split Finish Options

Choose any two colors to create a split finish that complements the interior and exterior of the home. Available on extended lead time.

Order 3-1/8" x 4" samples of finish colors at store.thermatru.com.

Sills



Standard / Recessed Standard

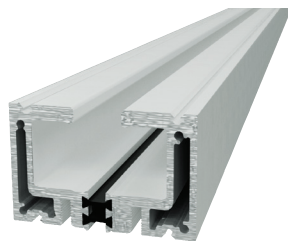

Recessed Flush*

Sill Finish Options

- Clear Anodized
- Dark Bronze Anodized

Handlesets

Active handlesets come standard with thumbturn interior lock with keyed exterior. See chart for availability.

The multi-point locking system engages the panel and frame at three points for enhanced security while helping to preserve the compression seal's hold, even under the pressure of high winds.



Handleset Finish Options

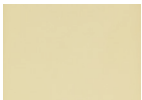

Brass



Brushed Nickel



Black Nickel



Satin Nickel

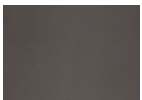

Oil-Rubbed Bronze

Availability

	Brass	Brushed Nickel	Black Nickel	Satin Nickel	Oil-Rubbed Bronze
Heirloom	Standard Lead Time	Standard Lead Time	Not Available	Standard Lead Time	Standard Lead Time
Venture	Standard Lead Time	Standard Lead Time	Standard Lead Time	Standard Lead Time	Standard Lead Time
Millennium	Standard Lead Time	Standard Lead Time	Standard Lead Time	Standard Lead Time	Standard Lead Time
Realm	Standard Lead Time	Not Available	Standard Lead Time	Standard Lead Time	Standard Lead Time



Standard Lead Time



Extended Lead Time



Not Available

*Door systems built with a flush sill have little resistance to water penetration and have a potential to leak if installed exposed to weather. We recommend these systems be installed away from weather under large soffits or overhangs.

Note: Finish colors may vary from an actual application due to fluctuations in finishing or printing. See your Therma-Tru seller for details on the Veris collection limited finish warranty and exclusions. Door systems built with a flush sill have little resistance to water penetration and have a potential to leak if installed exposed to weather. We recommend these systems be installed away from weather under large soffits or overhangs.

V-2 Details

Thermal Break Veris glass door systems feature thermal breaks, shown here in red.

Top- & Bottom-Load Sills

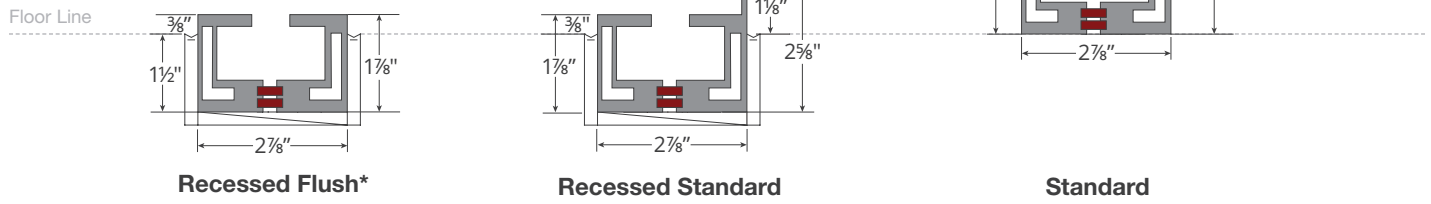

Vertical & Horizontal Rails

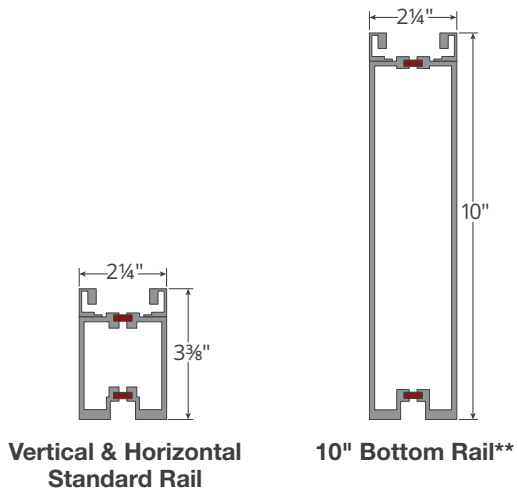

*Door systems built with a flush sill have little resistance to water penetration and have a potential to leak if installed exposed to weather. We recommend these systems be installed away from weather under large soffits or overhangs.

**For ADA compliance, the door must provide a minimum 32\" clear opening width. Verify all other ADA compliance requirements with your local building code official.



V-3 Details

Top- & Bottom-Load Sills

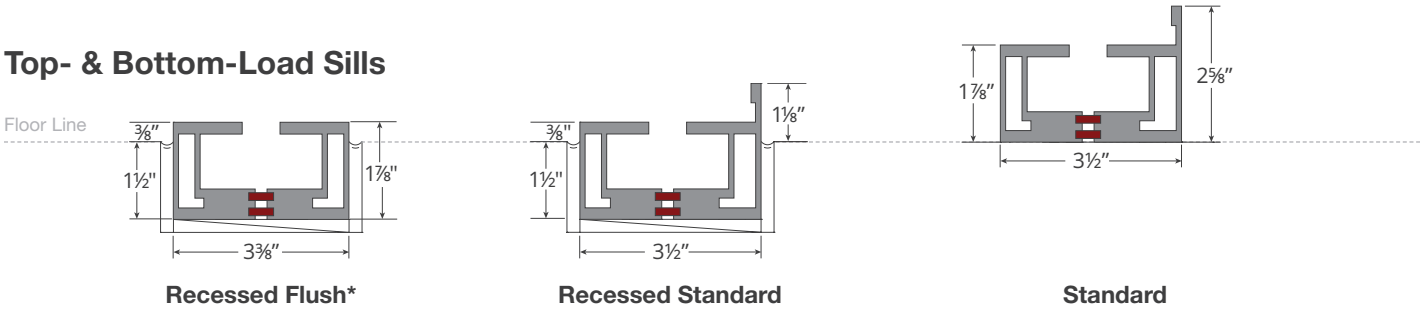

Vertical & Horizontal Rails

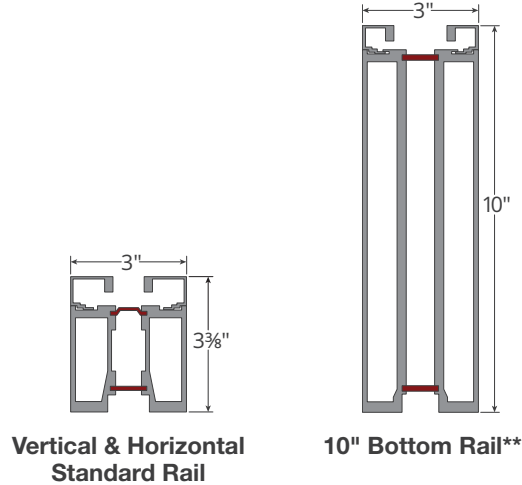

Scan to learn more.

THERMA TRU
DOORS



About the Veris™ Collection

Therma-Tru's Veris collection is manufactured by Solar Innovations – a recently acquired brand of Therma-Tru. Solar Innovations brings more than 20 years of open-air living product innovations, including these high-performing door systems. Featuring expansive glass, these door systems are ideal for contemporary front entries and connecting indoor and outdoor spaces around the home.

Lifetime Durability & Performance

Designed for easy, worry-free operation, we're so confident in our fully engineered systems that we back them with a 1x transferable lifetime limited warranty for peace of mind.

In addition, the finish is covered by a balance-transferable 10-year limited warranty.

Visit VerisCollection.com for details on limited warranties and exclusions.



THERMA-TRU
DOORS

Where Home Begins™

thermatru.com

1-800-THERMA-TRU (843-7628)

1750 Indian Wood Circle
Maumee, OH 43537



#thermatru

©2023 Therma-Tru Corp. All rights reserved. All trademarks and images featured are owned by their respective company and used with permission. Registered trademarks are registered in the U.S. and may be registered internationally. Therma-Tru Corp. and Solar Innovations LLC are part of Fortune Brands Innovations, Inc. – an industry-leading home and security products company. Neat+ is a trademark of Cardinal Glass Industries Inc. and is used here with permission.

Part #MAFVRSFDS23 MTZT / JAN 2023



Scan to learn more.