

# Hinged Glass Doors

THERMA TRU<sup>®</sup>  
DOORS



Simplistic styling with a contemporary look.

Discover a transitional design with a contemporary look that complements a wide range of styles. Veris hinged entry door systems welcome natural light into the home with a simplistic design available in single and french door configurations.

Veris<sup>™</sup>  
COLLECTION



# Confidence in a Complete System

Create the ultimate open-air living experience with superior performance thanks to our full-system approach. With the Veris™ collection, each piece is engineered to work together seamlessly.

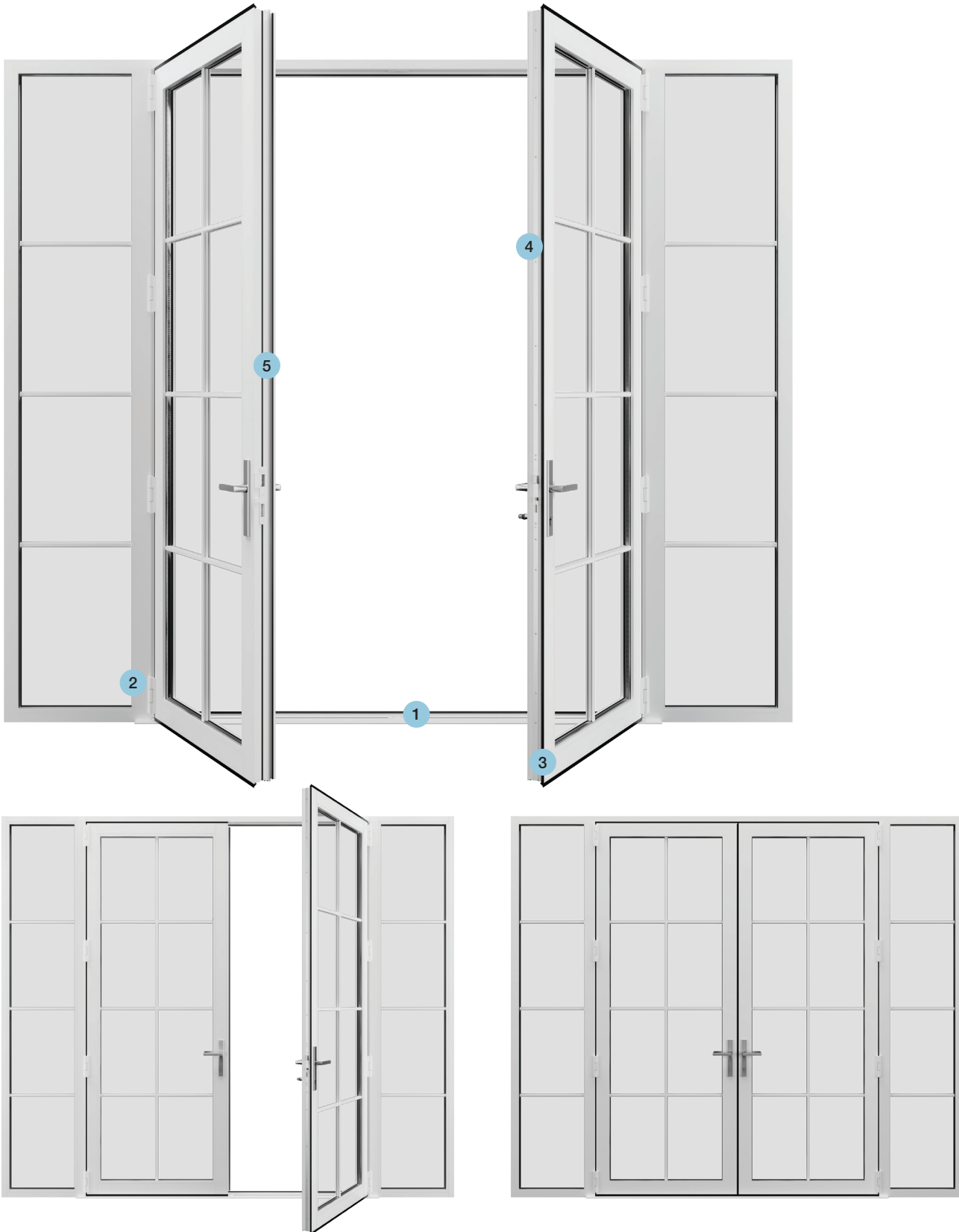

\*Door systems built with a flush sill have little resistance to water penetration and have a potential to leak if installed exposed to weather. We recommend these systems be installed away from weather under large soffits or overhangs.

\*\*For ADA compliance, the door must provide a minimum 32" clear opening width. Verify all other ADA compliance requirements with your local building code official.



Standard Inswing

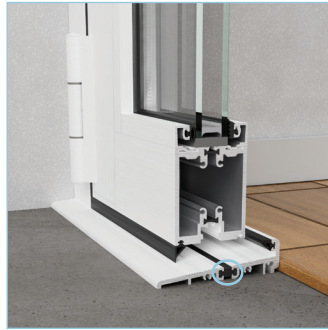

Standard Outswing

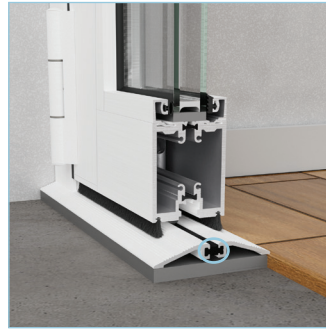

Flush\*

**Thermally broken sills** reduce the transfer of heat and cold through the door system for greater energy efficiency while reducing condensation buildup.

Sills are available in **standard** for water performance and **flush** for ADA compliance.\*\*



**Semi-concealed hinges** built into the panels blend with the door system. Manufactured in-house to high tolerances under tight quality control. Color match options are available.

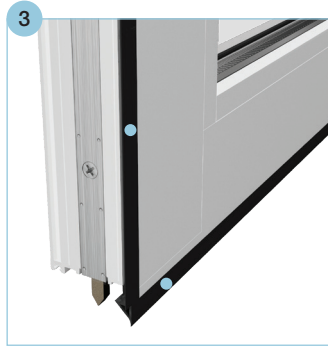

Designed to provide the best possible fit between panel and frame, the **weatherstrip** helps prevent water and air from entering the home.



**Thermal break design** separates interior and exterior aluminum to reduce heat and cold transfer between indoors and outdoors which helps reduce condensation.



As part of french door configurations, an **astragal** is integrated into the unit to assist with sealing the door system for better protection from the elements.

**THERMA TRU**  
DOORS



# V-2 vs. V-3



## V-2 Systems: Built for everyday life.

Our V-2 systems are designed to meet the needs for most homes and structures. Featuring our standard components that are quality tested for long-term use, the V-2 system is perfect for residential dwellings in most areas of the United States.

**Panel & System Thickness:**  
2-1/4"

**Maximum Height:** 8'



## V-3 Systems: Performance where you need it.

Our V-3 systems are engineered to meet the high-performance needs of specific regions, building codes and commercial structures, and are built to support larger glass panels found in our taller units. With high-performance components that can stand up to heavy-duty use, the V-3 system is ideal for structures and door units that require extra support and stability.

**Panel & System Thickness:** 3"  
**Maximum Height:** 10'

## Size Offering

Hinged configurations with a door that exceeds 8'0" in height or a transom that exceeds 8'0" in width will be built as a V-3 system.

| Doors       |       | Single |      |       |      |      |      | French |      |       |      |      |      |
|-------------|-------|--------|------|-------|------|------|------|--------|------|-------|------|------|------|
| Panel Width |       | 2'6"   | 2'8" | 2'10" | 3'0" | 3'6" | 4'0" | 2'6"   | 2'8" | 2'10" | 3'0" | 3'6" | 4'0" |
| Height      | 6'8"  |        |      |       |      |      |      |        |      |       |      |      |      |
|             | 7'0"  |        |      |       |      |      |      |        |      |       |      |      |      |
|             | 8'0"  |        |      |       |      |      |      |        |      |       |      |      |      |
|             | 9'0"  |        |      |       |      |      |      |        |      |       |      |      |      |
|             | 10'0" |        |      |       |      |      |      |        |      |       |      |      |      |

| Sidelites |       | 14" | 18" | 20" | 24" |
|-----------|-------|-----|-----|-----|-----|
| Width     |       | 14" | 18" | 20" | 24" |
| Height    | 6'8"  |     |     |     |     |
|           | 7'0"  |     |     |     |     |
|           | 8'0"  |     |     |     |     |
|           | 9'0"  |     |     |     |     |
|           | 10'0" |     |     |     |     |

| Transoms    |     | Single with or without Sidelite(s) |      |       |      |      |      |
|-------------|-----|------------------------------------|------|-------|------|------|------|
| Panel Width |     | 2'6"                               | 2'8" | 2'10" | 3'0" | 3'6" | 4'0" |
| Height      | 14" |                                    |      |       |      |      |      |
|             | 18" |                                    |      |       |      |      |      |
|             | 20" |                                    |      |       |      |      |      |
|             | 24" |                                    |      |       |      |      |      |

| Transoms    |     | French |      |       |      |      |      | French with Two Sidelites |      |       |      |      |      |
|-------------|-----|--------|------|-------|------|------|------|---------------------------|------|-------|------|------|------|
| Panel Width |     | 2'6"   | 2'8" | 2'10" | 3'0" | 3'6" | 4'0" | 2'6"                      | 2'8" | 2'10" | 3'0" | 3'6" | 4'0" |
| Height      | 14" |        |      |       |      |      |      |                           |      |       |      |      |      |
|             | 18" |        |      |       |      |      |      |                           |      |       |      |      |      |
|             | 20" |        |      |       |      |      |      |                           |      |       |      |      |      |
|             | 24" |        |      |       |      |      |      |                           |      |       |      |      |      |

Standard Lead Time
  Extended Lead Time

# Configurations

Shown from the exterior side of the door system.

Available as inswing or outswing.



Single

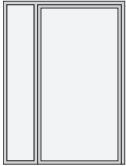

Single with Left Sidelite



Single with Right Sidelite

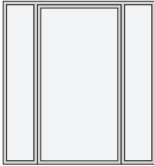

Single with Two Sidelites



Single with Transom

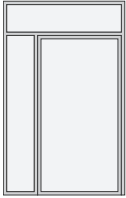

Single with Left Sidelite and Transom

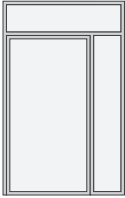

Single with Right Sidelite and Transom

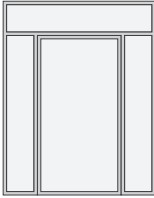

Single with Two Sidelites and Transom



French

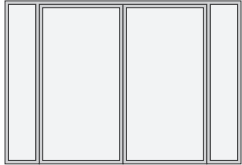

French with Two Sidelites

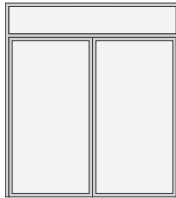

French with Transom

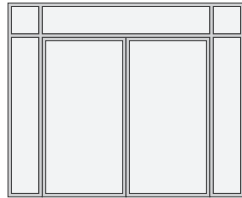

French with Two Sidelites and Transoms

**THERMA TRU**  
DOORS



# Glass Options



## Enhanced Low-E

Blocks 95% of the sun's harmful UV rays, helping to preserve the color and materials of your interior furnishings, draperies and wall treatments.\*



## Low-E

Delivers exceptional energy efficiency, retaining heat in the winter and reflecting it in the summer.



## Turtle with Low-E

Tinted gray to reduce interior light projection as required near sea turtle nesting areas. Includes Low-E coating for exceptional energy efficiency.

## Optional Neat+™ Coating

All Low-E glass in the Veris collection is available with Neat+ coating. This low-maintenance coating is designed to help keep glass clear and free of watermarks, reducing the need for cleaning.\*



Without  
Neat+ Coating

With  
Neat+ Coating



\*For more information on enhanced Low-E glass and Neat+ coating, visit [www.solarinnovations.com](http://www.solarinnovations.com).

# Divided Lites

## Available Patterns

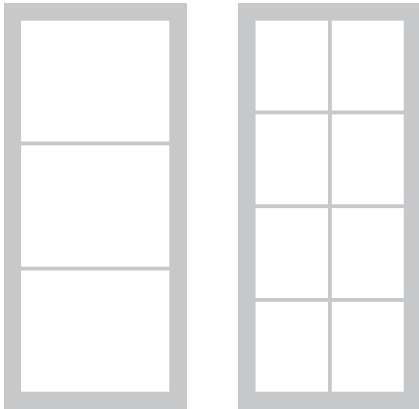

1X3

2X4

## Grilles Between Glass (GBGs)



GBGs are sealed between two panes of tempered glass for a smooth easy-to-clean surface.

Height:  $\frac{5}{8}$ "  
Depth:  $\frac{3}{16}$ "

## Finish Options for GBGs



White



Black

Split finish not available for GBGs.

## Simulated Divided Lites (SDLs) with Grilles Between Glass (GBGs)

SDLs are adhered to the interior and exterior panes of tempered glass and are finished to complement the door system. For a more authentic divided lite look, SDLs are layered over black GBGs.

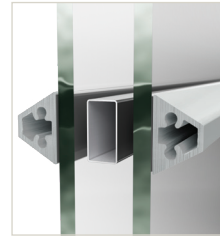

**Traditional Profile**

Height:  $\frac{3}{4}$ "  
Depth:  $\frac{15}{32}$ "

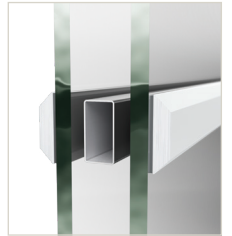

**Flat Profile**

Height:  $\frac{3}{4}$ "  
Depth:  $\frac{5}{32}$ "

## Configurations with SDL / GBG Patterns

### 1X3

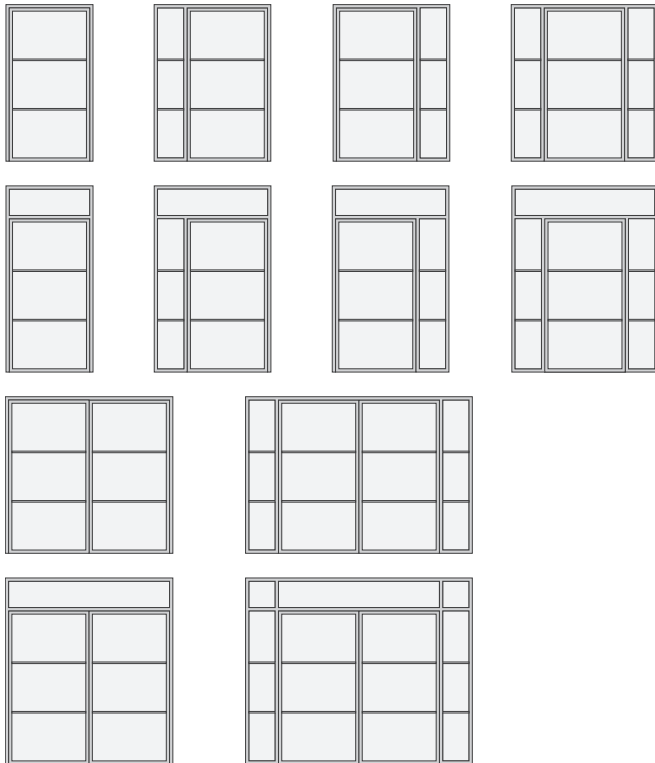

### 2X4

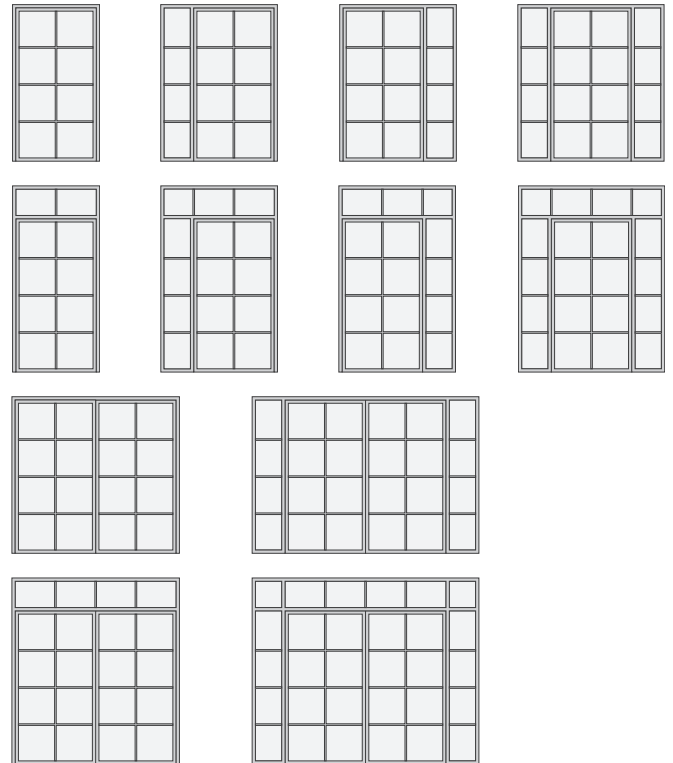

# Finish

Choose from an on-trend assortment of finishes designed to complement most homes.

## Standard Lead Powder Coated

Similar to semi-gloss finish.

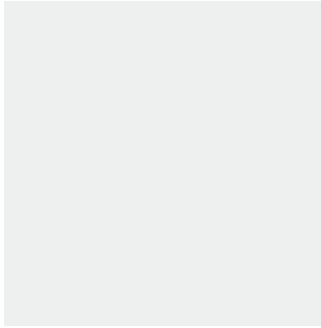

White



Black

## Standard Lead Anodized

Similar to eggshell finish.



Clear

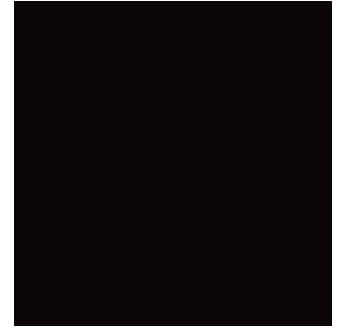

Dark Bronze

## Extended Lead Powder Coated

Similar to semi-gloss finish.

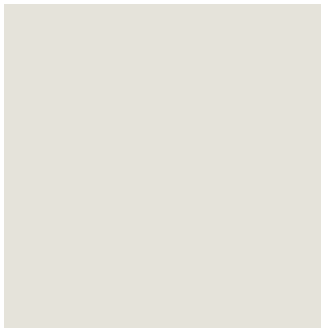

Bone White

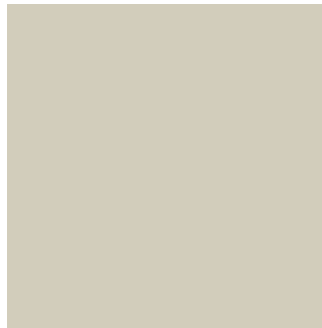

Sandstone

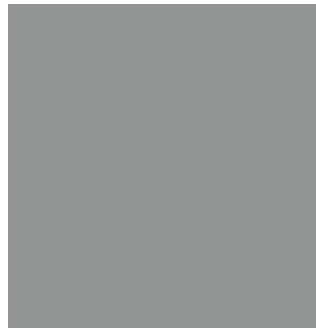

Fashion Gray



Charcoal



White / Black

### Additional Split Finish Options

Choose any two colors to create a split finish that complements the interior and exterior of the home. Available on extended lead time.

Order 3-1/8" x 4" samples of finish colors at [store.thermatru.com](http://store.thermatru.com).

# Sills



Flush Sill\* (ADA)



Standard Sill Inswing



Standard Sill Outswing

### Sill Finish Options

- Clear Anodized
- Dark Bronze Anodized

\*Door systems built with a flush sill have little resistance to water penetration and have a potential to leak if installed exposed to weather. We recommend these systems be installed away from weather under large soffits or overhangs. For ADA compliance, the door must provide a minimum 32" clear opening width. Verify all other ADA compliance requirements with your local building code official.

Note: Finish colors may vary from an actual application due to fluctuations in finishing or printing. See your Therma-Tru seller for details on the Veris collection limited finish warranty and exclusions.



# Handlesets

Active handlesets come standard with thumbturn interior lock with keyed exterior.

The multi-point locking system engages the panel and frame at three points for enhanced security while helping to preserve the compression seal's hold, even under the pressure of high winds.

Inspira and Verge handlesets deliver the minimalist style of a modern door pull. The handles are partially offset from the rail for comfortable access to the lock. The lock features an interior thumbturn and exterior keyed options. French door systems and 10' door systems will also include flush bolts.

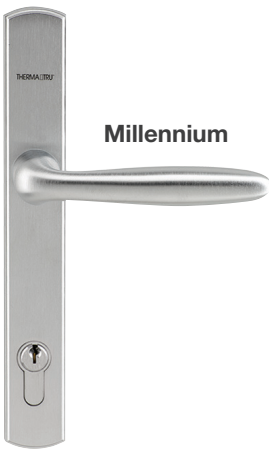

Linear pulls are sized proportionally to the door height and will feature a third connection point for 9'0" and 10'0" doors.

## Handleset Finish Options

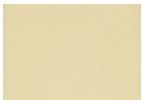

Brass



Brushed Nickel



Black Nickel



Satin Nickel

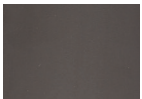

Oil-Rubbed Bronze

## Availability

|                   | Brass | Brushed Nickel | Black Nickel | Satin Nickel | Oil-Rubbed Bronze |
|-------------------|-------|----------------|--------------|--------------|-------------------|
| <b>Heirloom</b>   |       |                |              |              |                   |
| <b>Venture</b>    |       |                |              |              |                   |
| <b>Millennium</b> |       |                |              |              |                   |
| <b>Realm</b>      |       |                |              |              |                   |
| <b>Inspira</b>    |       |                |              |              |                   |
| <b>Verge</b>      |       |                |              |              |                   |



Standard Lead Time



Extended Lead Time



Not Available

# V-2 Details

**Thermal Break** Veris glass door systems feature thermal breaks, shown here in red.

## Sills

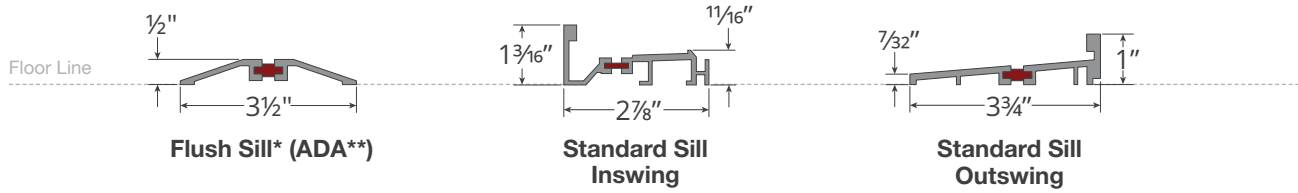

## Vertical & Horizontal Rails

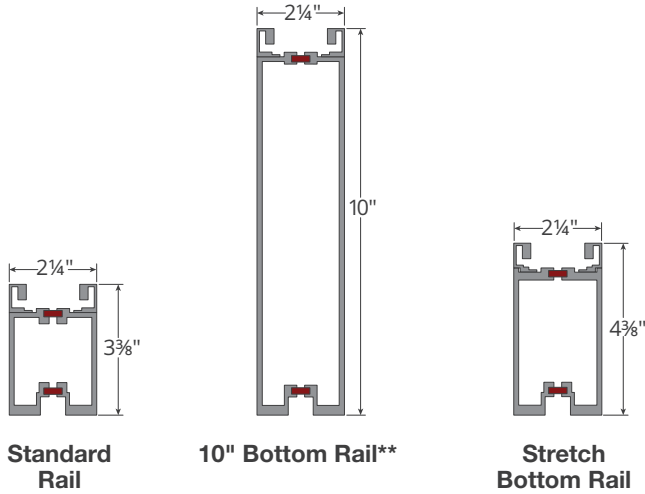

\*Door systems built with a flush sill have little resistance to water penetration and have a potential to leak if installed exposed to weather. We recommend these systems be installed away from weather under large soffits or overhangs.  
\*\*For ADA compliance, the door must provide a minimum 32" clear opening width. Verify all other ADA compliance requirements with your local building code official.



# V-3 Details

## Sills

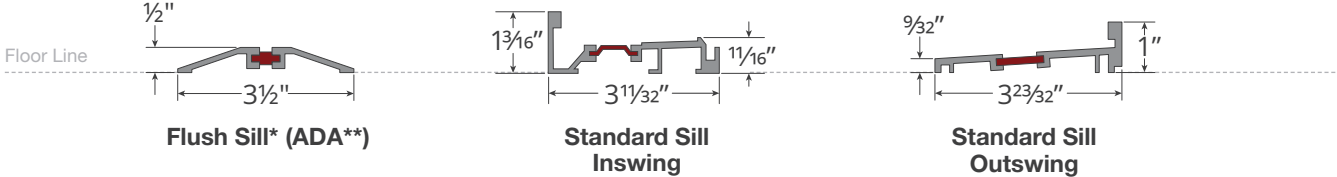

## Vertical & Horizontal Rails

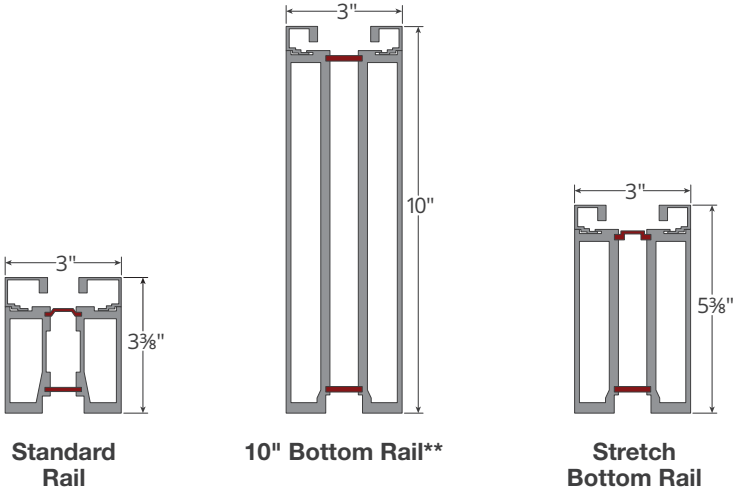

Scan to learn more.

**THERMA TRU**  
DOORS



## About the Veris™ Collection

Therma-Tru's Veris collection is manufactured by Solar Innovations – a recently acquired brand of Therma-Tru. Solar Innovations brings more than 20 years of open-air living product innovations, including these high-performing door systems. Featuring expansive glass, these door systems are ideal for contemporary front entries and connecting indoor and outdoor spaces around the home.

## Lifetime Durability & Performance

Designed for easy, worry-free operation, we're so confident in our fully engineered systems that we back them with a 1x transferable lifetime limited warranty for peace of mind.

In addition, the finish is covered by a balance-transferable 10-year limited warranty.

Visit [VerisCollection.com](http://VerisCollection.com) for details on limited warranties and exclusions.



**THERMA TRU**  
DOORS

Where Home Begins™

[thermatru.com](http://thermatru.com)

1-800-THERMA-TRU (843-7628)

1750 Indian Wood Circle  
Maumee, OH 43537



#thermatru



©2023 Therma-Tru Corp. All rights reserved. All trademarks and images featured are owned by their respective company and used with permission. Registered trademarks are registered in the U.S. and may be registered internationally. Therma-Tru Corp. and Solar Innovations LLC are part of Fortune Brands Innovations, Inc. – an industry-leading home and security products company. Neat+ is a trademark of Cardinal Glass Industries Inc. and is used here with permission.

Part #MAFVRSHDS23 MTZT / JAN 2023

Scan to learn more.